

Clavinova®

CVP-709

CVP-705

Reference Manual

This manual explains the functions called up by touching each icon shown in the Menu display, as well as other detailed functions and operations.

Please read the Owner's Manual first for basic operations, before reading this Reference Manual.

Using the PDF manual

- To quickly jump to items and topics of interest, click on the desired items in the “Bookmarks” index to the left of the main display window. (Click the “Bookmarks” tab to open the index if it is not displayed.)
- Click the page numbers that appear in this manual to go directly to the corresponding page.
- Select “Find” or “Search” from the Adobe Reader “Edit” menu and enter a keyword to locate related information anywhere in the document.

NOTE The names and positions of menu items may vary according to the version of Adobe Reader being used.

- Unless indicated otherwise, the illustrations and displays as shown in this manual are based on the CVP-709 (in English). These are for instructional purposes only, and may appear somewhat different from those on your instrument.
- The explanations in this manual apply to the firmware version 1.00. Yamaha may from time to time update firmware of the product without notice for improvement. We recommend that you check our website for later releases and upgrade your firmware. <http://download.yamaha.com/>
- The company names and product names in this manual are the trademarks or registered trademarks of their respective companies.

Contents

Chapter 1

Functions Called Up by Touching Each Icon Shown in the Menu Display

This chapter explains the functions called up by touching each of the icons shown in the Menu display.

Adjusting the Tempo.....	5
Transposing the Pitch in Semitones	6
Changing the Split Point, Fingering Type and Chord Detection Area.....	7
Learning How To Play Specific Chords (Chord Tutor)	8
Adjusting the Volume Balance.....	9
Editing the Volume and Tonal Balance (Mixer).....	10
Editing Music Notation (Score) Settings	18
Editing Lyrics Display Settings	20
Showing the Text Display and Editing Text Display Settings.....	21
Using Keyboard Harmony	23
Microphone Settings.....	25
Vocal Harmony Settings.....	27
Creating/Editing Music Finder Records	32
Calling Up Registration Memory Numbers in Order (Registration Sequence)	35
Disabling Recall of Specific Items (Registration Freeze)	37
Assigning a Specific Function to Each Pedal or ASSIGNABLE button.....	38
Editing a Voice (Voice Edit)	42
Editing an Organ Flutes Voice (Voice Edit)	46
Creating/Editing Styles (Style Creator)	48
Creating/Editing MIDI Songs (Song Creator).....	61
Voice Settings	73
Style Playback Related Settings	78
Song Settings Related to Playback/Recording	81
Fine Tuning the Pitch	86
Setting the Touch Sensitivity of the Keyboard	88
Metronome Settings	89
MIDI Settings	90
Making Global Settings (Utility).....	96
Wireless LAN Settings	101
Making the Time Settings.....	103

Chapter 2 Other Functions and Settings

This chapter explains the detailed functions and operations called up by displays not included in the Menu display.

Adjusting the Accompaniment Volume or Turning Each Accompaniment Part On/Off in the Piano Room	105
Displaying the Instruments Assigned to the Keyboard (Drum Kit Tutor)	107
Recording the Right- and Left-hand Parts Separately (MIDI Recording).....	108
Recording Style Playback First, Then Melodies.....	112
Index	116

Clicking on an icon in the illustration below automatically jumps to the corresponding instruction page for the function.

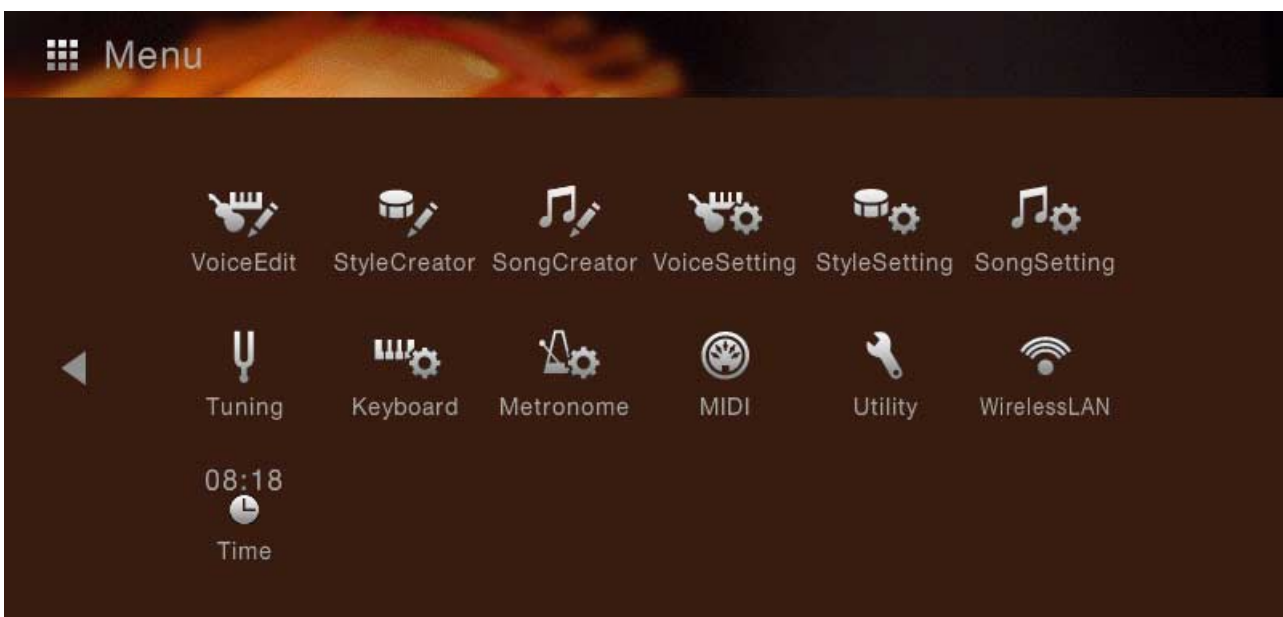
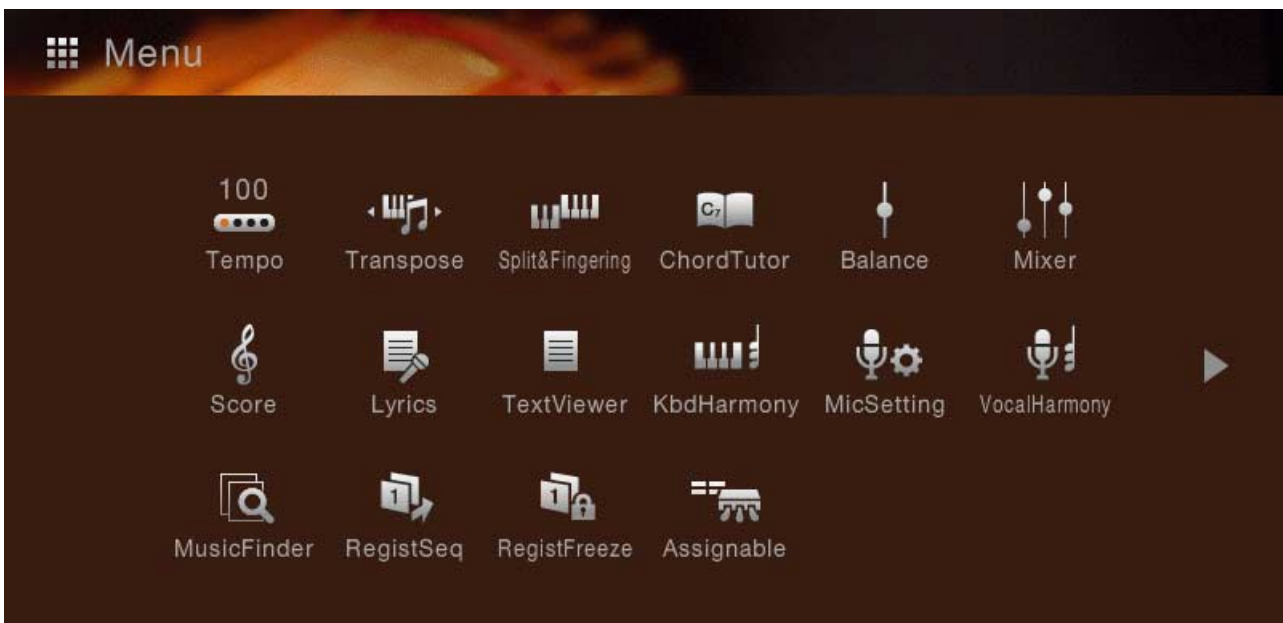

*The icons of "WirelessLAN" and "Time" are shown only when the USB Wireless LAN adaptor (which may not be included depending on your area) is connected to the [USB TO DEVICE] terminal.

Chapter 1

Functions Called Up by Touching Each Icon Shown in the Menu Display

This chapter explains the functions called up by touching each of the icons shown in the Menu display.



Adjusting the Tempo

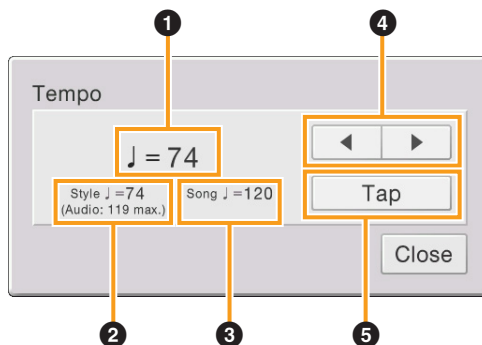

❶	Indicates the tempo value during playback of the metronome, Style and MIDI Song.
❷	Indicates the tempo value of the current Style. The Style will be started at this tempo. When you select an Audio Style (CVP-709 only), the upper limit of the tempo will be shown below the tempo value. The Audio part is muted if the tempo is over the upper limit.
❸	Indicates the tempo value of the current MIDI Song. The Song will be started at this tempo.
❹	These are basically equivalent to the TEMPO [-]/[+] buttons on the panel. If you want to call up the default tempo of the current Style and MIDI Song, touch and hold any area in ❶ – ❸.
❺	Equivalent to the [TAP TEMPO] button on the panel.

NOTE The tempo value of an Audio Song is set via the Time Stretch function. Refer to the Owner's Manual.

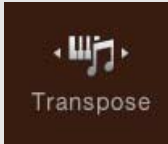

Transposing the Pitch in Semitones

You can transpose the overall pitch of the instrument (the keyboard sound, Style playback, MIDI Song playback, and so on) in semitone steps.

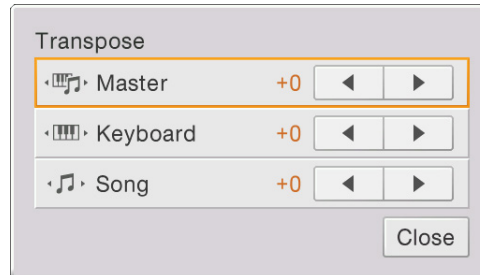

Master	Transposes the overall pitch of the instrument, except for the Audio Songs and input sound from a microphone or the [AUX IN] jack.
Keyboard	Transposes the pitch of keyboard including Style playback (controlled via the chord section of the keyboard).
Song	Transposes only the pitch of MIDI Song playback.

NOTE The pitch of an Audio Song is adjusted via the Pitch Shift function. Refer to the Owner's Manual.

NOTE Transpose is not applied to the Drum Kits and SFX Kits Voice.



Changing the Split Point, Fingering Type and Chord Detection Area

Split Point/Fingering Type

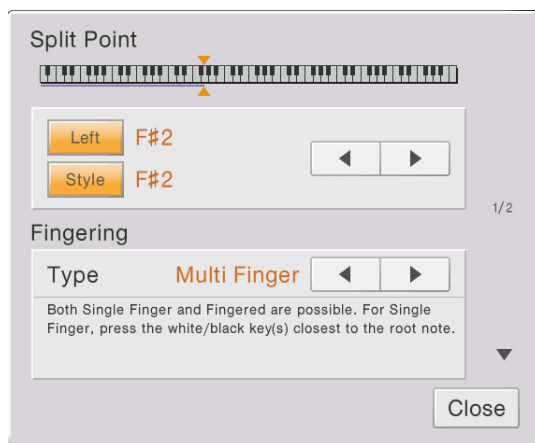

For information about Split Point and Fingering Types, refer to the Owner's Manual.

Specifying Chords with Your Right Hand for Style Playback

By changing the Chord Detection area from the left-hand section to the right-hand section, you can play a bass line with your left hand while using your right hand to play chords for controlling Style playback.

1 Call up the Split Point/Fingering window: [Menu] → [Split&Fingering] → page 2/2.

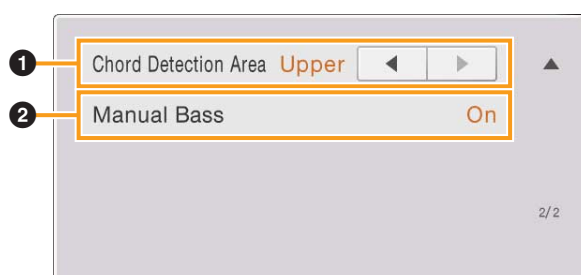

2 Make the necessary settings by touching the display.

<p>1</p>	<p>Chord Detection Area</p>	<p>Select "Upper." The Chord section is set to the right of the left split point. Fingering type is set to "Fingered*" automatically by the default settings.</p> <p>NOTE "Fingered*" is basically same as "Fingered," except that "1+5," "1+8" and Chord Cancel are not available.</p> <p>NOTE For information about when the "Chord Detection Area" is set to "Lower," refer to the Owner's Manual.</p>
<p>2</p>	<p>Manual Bass</p>	<p>Manual Bass is set to "On" automatically by the default settings when you select "Upper" in the Chord Detection Area above.</p> <p>Bass part of the current Style is muted and assigned to the left part.</p> <p>NOTE This parameter is available only when the "Chord Detection Area" is set to "Upper."</p>



Learning How To Play Specific Chords (Chord Tutor)

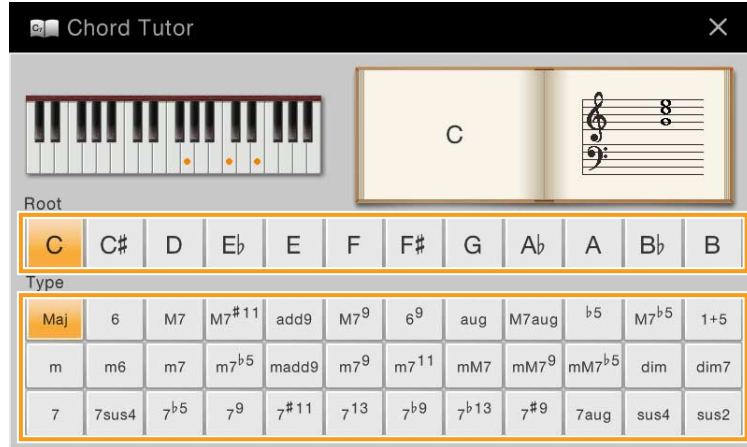

If you know the name of a chord but don't know how to play it, this function indicates you the notes you should press.

Root	Lets you select the desired Chord Root.
Type	Lets you select the desired Chord Type.

NOTE Depending on the chord, some notes may be omitted.



Adjusting the Volume Balance

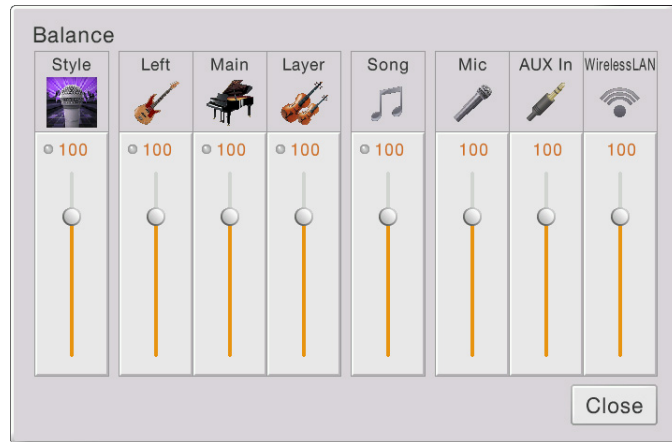

For information about this display, refer to the Owner's Manual.



Editing the Volume and Tonal Balance (Mixer)

The “Panel” – “Song Ch9-16” Part Selection tabs at the top of the Mixer display let you adjust the sound for each corresponding part, while “Master” lets you make overall sound adjustments for the entire instrument.

NOTE When an Audio Song is selected, you cannot set the parameters related to the Song part or channels.

NOTE Knobs and sliders appear on the setting displays only when the relevant parameters are available.

For a visual indication of the signal flow and configuration of the Mixer, refer to the Block Diagram on [page 17](#).

Filter

This function modifies the tonal characteristics (brightness, etc.) of the sound by cutting the output of a specific frequency portion of the sound. This is not available when you select “Master” from among the tabs at the top of the Mixer display.

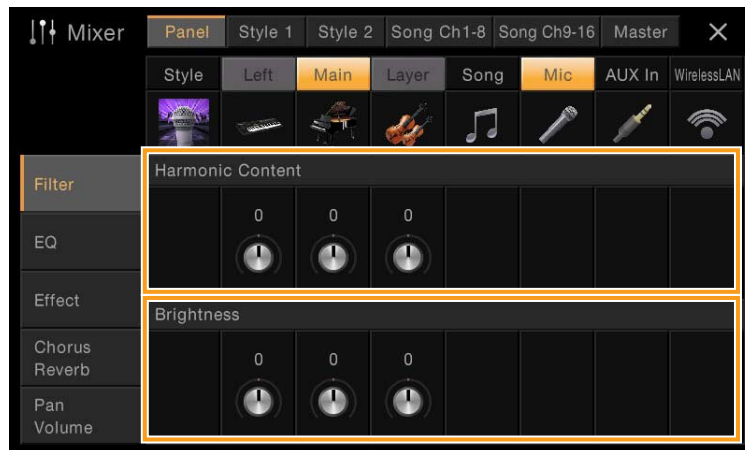

Harmonic Content	Allows you to adjust the Resonance effect (page 44) for each part. This can be used in combination with the “Brightness” parameter to add further character to the sound.
Brightness	Determines the brightness of the sound for each part by adjusting the cutoff frequency (page 44).

EQ (Equalizer)

Equalizer (also called “EQ”) is a sound processor that divides the frequency spectrum into multiple bands that can be boosted or cut as required to tailor the overall frequency response. The “Panel” – “Song Ch9-16” Part Selection tabs at the top of the Mixer display let you adjust the EQ for each corresponding part, while “Master” lets you make overall EQ adjustments for the entire instrument.

Part EQ (when one of the “Panel” – “Song Ch 9-16” tabs is selected)

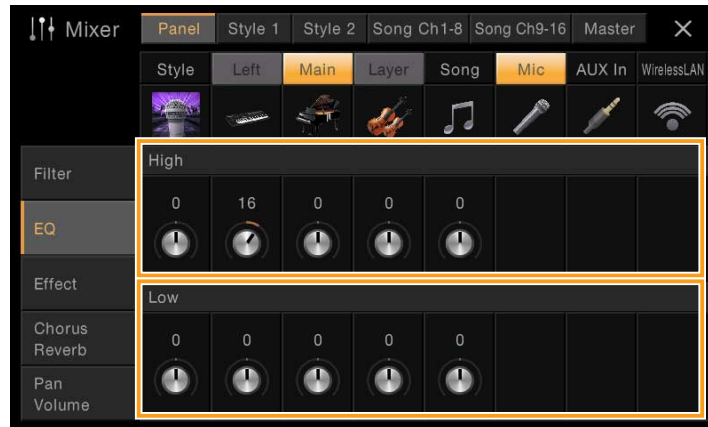

High	Boosts or attenuates the high EQ band for each part.
Low	Boosts or attenuates the low EQ band for each part.

Master EQ (when the “Master” tab is selected)

This instrument possesses a high-quality five-band digital EQ. With this function, a final effect — tone control — can be applied to the output of your instrument. You can select one of the five preset EQ types in the “Master” display. You can even create your own custom EQ settings by adjusting the frequency bands, and save the settings to one of two User Master EQ types.

NOTE Master EQ cannot be applied to an Audio Song or the Metronome sound.

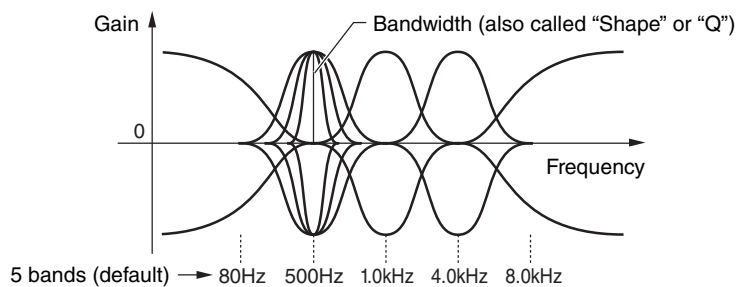

NOTE If the display shown here is not called up, press the “EQ” tab at left.

1 Select the desired EQ type to be edited.

- **FLAT:** Flat EQ settings. The gain of each frequency is set to 0dB.
- **LOW CUT:** EQ setting for decreasing the level of the low frequencies, making the sound clearer.
- **LOW BOOST:** EQ setting for boosting the level of the low frequencies, making the sound more powerful.
- **HIGH CUT:** EQ setting for decreasing the level of the high frequencies, making the sound more mellow.
- **HIGH BOOST:** EQ setting for boosting the level of the high frequencies, making the sound brighter.
- **User1/2:** Your own custom EQ settings saved in step 4.

2 Adjust the Q (bandwidth) and the Center Frequency of each band.

The available Frequency range is different for each band. The higher the value of Q, the narrower the bandwidth.

3 Boost or cut each of the five bands as desired.

4 Touch (Save) then save the settings as a User Master EQ type.

Up to two EQ types can be created and saved.

NOTICE

The settings will be lost if you turn the power to the instrument off without executing the Save operation.

NOTE If you want to save the Master EQ settings to the USB flash drive, save as a User Effect file. To do this, from the display called up via [Menu] → [Utility] → [Factory Reset/Backup] → page 2/2, touch [Backup] of “User Effect” to execute the Save operation (page 99).

Effects

This instrument features the following Effect Blocks.

- **System Effect (Chorus, Reverb):** These Effects are applied to the entire sound of this instrument. For each part, you can adjust the depth of the System Effect. Refer to “Chorus/Reverb” (page 14).
- **Insertion Effect 1 – 8 (CVP-709) / Insertion Effect 1 – 3 (CVP-705):** These Effects are applied only to a specific part. For each of these Effects, select an Effect type specifically for the desired part (for example, Distortion, which would be applied only to the Guitar part).
- **Variation Effect:** This Block can be used both as System Effects and Insertion Effects, and you can switch between them.

These explanations cover the settings related to the Insertion Effects and Variation Effects on the Effect display. This display is not available when the “Master” tab is selected at the top of the Mixer display.



Insertion Effect	<p>Lets you assign the desired Insertion Effect Type for each part by touching the area above each knob. You can adjust the degree to which each Effect is applied by using the knobs. If you want to assign each of the Insertion Effects to a specific Part and select an Effect Type, touch  (Setting) at the upper right of this area and make necessary settings in the window. The assignable Parts for each Insertion Effect are as follows:</p> <ul style="list-style-type: none"> ■ CVP-709 <ul style="list-style-type: none"> • Insertion Effect 1 – 5: Keyboard Parts, Song channels 1 – 16 • Insertion Effect 6: Microphone, Song channels 1 – 16 • Insertion Effect 7 – 8: Style Parts (except the Audio Part of the Audio Style (CVP-709 only)) ■ CVP-705 <ul style="list-style-type: none"> • Insertion Effect 1 – 2: Keyboard Parts, Song channels 1 – 16 • Insertion Effect 3: Microphone, Keyboard Parts, Song channels 1 – 16 <p>NOTE On the CVP-705, Insertion Effects cannot be applied to the Style parts.</p>
Variation Effect	<p>Touch [INSERTION] or [SYSTEM] to switch the Effect Connection between the Insertion Effect and System Effect, then touch the right end of this line to select the desired Effect type. When “SYSTEM” is selected, this Effect is applied to all parts of the Song and Style as the System Effect. When “INSERTION” is selected, this Effect is applied only to the specified Song/Style part.</p> <p>To adjust the degree to which the Effect is applied, use the knob of each part.</p>

NOTE For details about the Effect types, refer to the Data List.

Editing and Saving the Effect settings

You can edit the settings of the System Effects (Chorus, Reverb), Insertion Effects and Variation Effect. The edits can be saved as a User Effect type.

- 1** From the Mixer display, touch the desired Effect type to call up the Effect Type Selection display.
- 2** Select the Effect type if necessary, then touch  (Setting) to call up the Effect Parameter display.

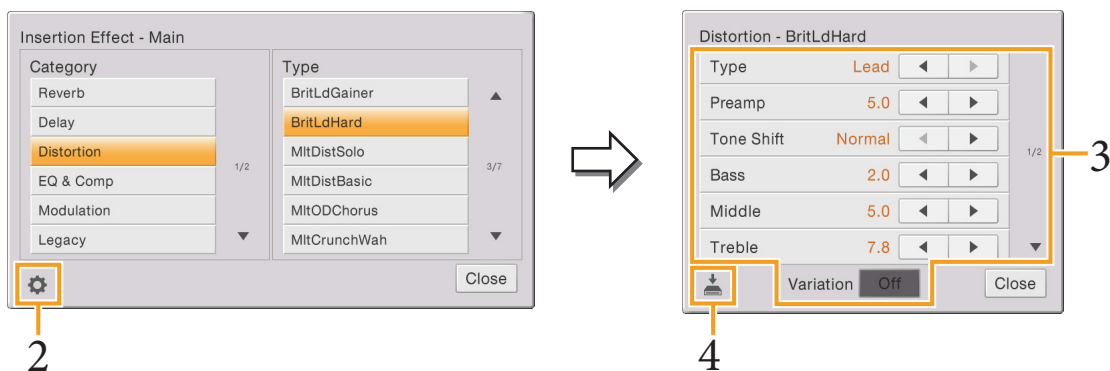

- 3** Make the necessary setting for each parameter.
The available parameters differ depending on the Effect type.

Each Insertion Effect Type features a Variation which is turned off by default. You can use this Variation and adjust the depth of some parameters by turning it on when the Insertion Effect is applied to the Main, Layer or Left part.

NOTE “Variation” [ON]/[OFF] is not displayed when the Insertion Effect is applied to parts other than Main, Layer or Left.

NOTE Parameters that are grayed out cannot be edited.

4 Touch (Save), then save the settings as a User Effect type.

Up to 3 Effect types can be stored for each of the Reverb, Chorus and Variation Effect Blocks while up to 10 Effect types can be stored for the Insertion Effect Blocks.

NOTICE

The settings will be lost if you turn the power to the instrument off without executing the Save operation.

NOTE If you want to save the Effect settings to a USB flash drive, save as a User Effect file. To do this, from the display called up via [Menu] → [Utility] → [Factory Reset/Backup] → page 2/2, touch [Backup] of “User Effect” to execute the Save operation (page 99).

Chorus/Reverb

As described in the previous section, Chorus and Reverb are System Effects which are applied to the entire sound of the instrument. They are not available when the “Master” tab is selected at the top of the mixer display.



Chorus	Touch the Chorus type name at the top right of this row to select the desired Chorus type. After selecting, return to the Mixer display then use each knob to adjust the Chorus depth for each part.
Reverb	Touch the Reverb type name at the top right of this row to select the desired Reverb type. After selecting, return to the Mixer display then use each knob to adjust the Reverb depth for each part.

When VRM Voices are selected, “VRM” indications appear under the knobs of the parts. If VRM Voices are selected for multiple parts, the Chorus depth and the Reverb depth are applied commonly to all these parts.

NOTE For details about the Chorus and Reverb types, refer to the Data List (Effect Type List).

Editing and Saving the Chorus/Reverb settings

Same as the operation on the “Effect” display (page 13).

Pan/Volume

You can adjust the Pan (stereo position of the sound) and Volume for each Part. This display is not available when the “Master” tab is selected at the top of the Mixer display.



❶	Pan	Determines the stereo position of each part (channel).
❷	Volume	Determines the level of each part or channel, giving you fine control over the balance of all the parts.

Master Compressor

Compressor is an effect commonly used to limit and compress the dynamics (softness/loudness) of an audio signal. For signals that vary widely in dynamics, such as vocals and guitar parts, it “squeezes” the dynamic range, effectively making soft sounds louder and loud sounds softer. When used with gain to boost the overall level, this creates a more powerful, more consistently high-level sound.

This instrument features a Master Compressor which is applied to the entire sound of this instrument. Although preset Master Compressor settings are provided, you can also create and save your original Master Compressor presets by adjusting the related parameters. This display is available only when the “Master” tab is selected at the top of the Mixer display.

NOTE Master Compressor cannot be applied to an Audio Song or the Metronome sound.

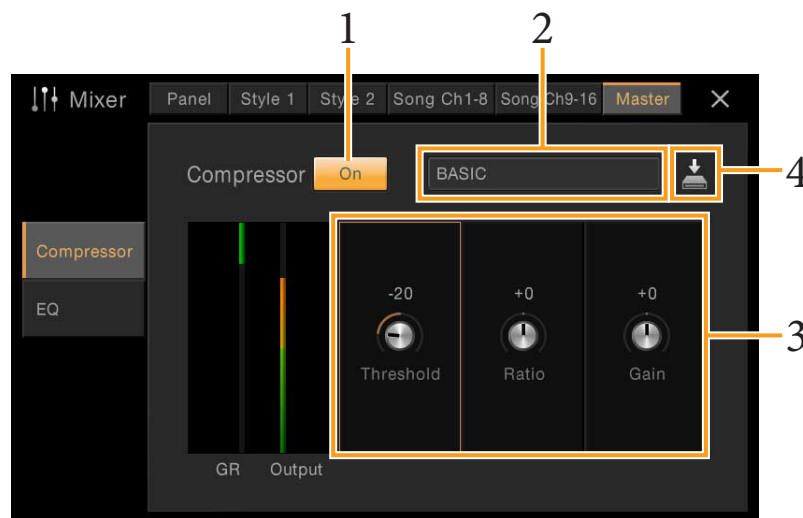

- 1 Set the Compressor to “On.”
- 2 Select the Master Compressor type to be edited.
- 3 Edit the parameters related to the Master Compressor.

Threshold	Determines the threshold (minimum level at which compression starts).
Ratio	Determines the ratio of compression (how much the dynamic range is compressed).
Gain	Determines the output level.

The indication “GR” shows the Gain Reduction (compressed level) while “Output” shows the output level according to the instrument sound in real time.

- 4 Touch  (Save), then save the settings as a User Master Compressor type.
Up to five Master Compressor types can be created and saved.

NOTICE

The settings will be lost if you turn the power to the instrument off without executing the Save operation.

NOTE If you want to save the Master Compressor settings to a USB flash drive, save them as a User Effect file. To do this, from the display called up via [Menu] → [Utility] → [Factory Reset/Backup] → page 2/2, touch [Backup] of “User Effect” to execute the Save operation (page 99).

Block Diagram

CVP-709

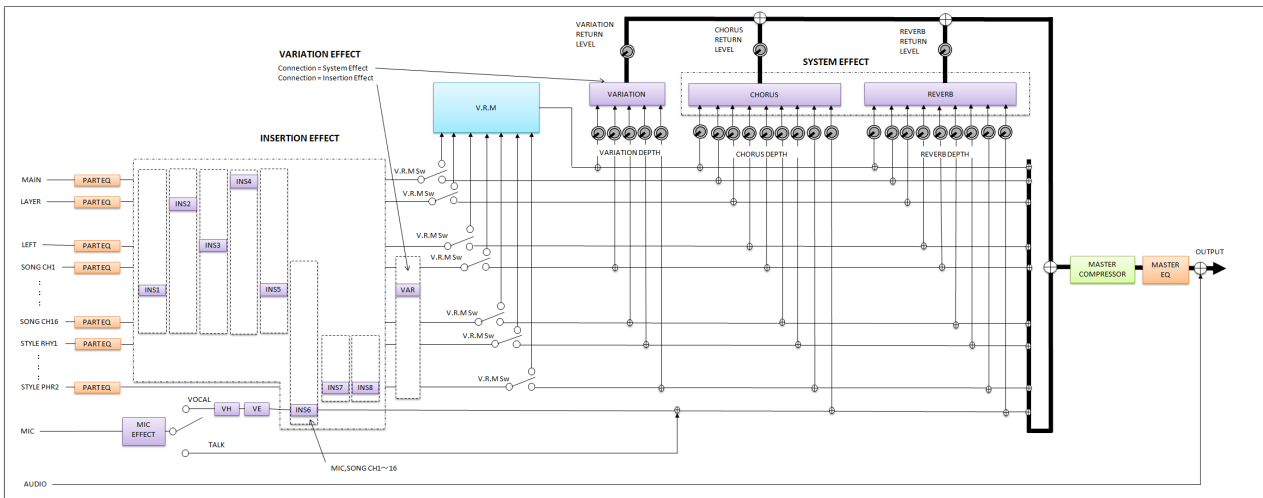

CVP-705

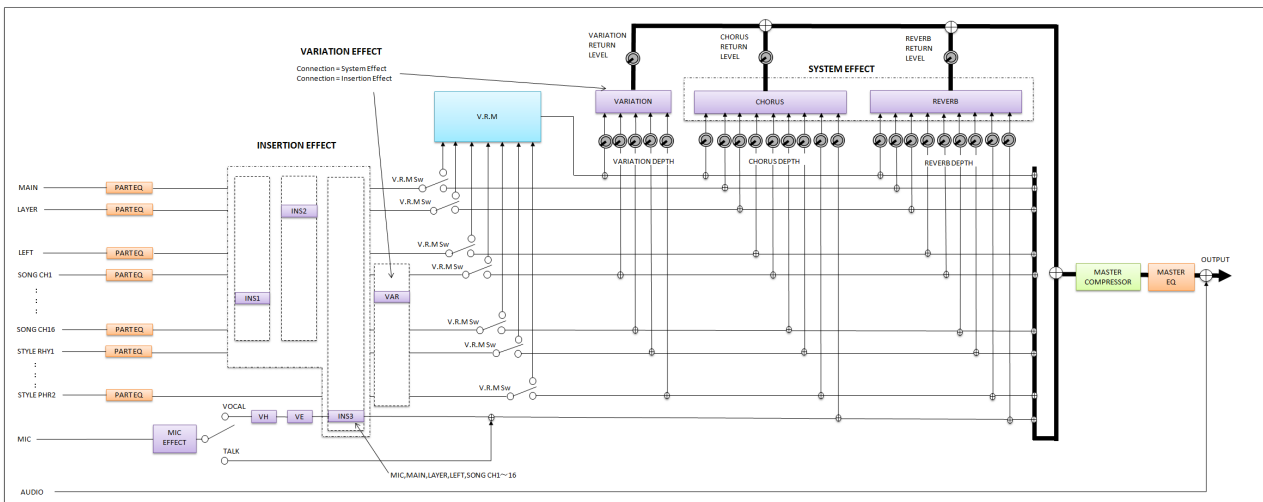

* MIC EFFECT = 3 Band EQ/Noise Gate/Compressor, VH = Vocal Harmony, VE = Vocal Harmony Effect



Editing Music Notation (Score) Settings

Select a MIDI Song then touch [Score] to call up the music notation of the current MIDI Song. You can change the notation indication as desired to suit your personal preferences.



①	Indicates the name of the current Song. Also, the tempo value is shown at the right end. If you want to change the Song, touch the Song name to call up the Song Selection display.
②	Lets you set the parameters related to playback Parts of the MIDI Song. For details, refer to “Play Setting” (page 18).
③	Lets you set the notation indication parameters, including notation size, chord display, etc. For details, refer to “View Setting” (page 19).
④	Lets you set more detailed parameters related to the notation indication. Refer to “Detail Setting” (page 19).

Play Setting

From the display called up via (Play Setting), you can set the parameters related to playback of the current MIDI Song. The parameters explained here can also be set on the Song area (with expanded) of the Home display.

Extra	Turns playback of all Channels on or off, except for those assigned to the Left and Right Hand Parts described below.
Left	Turns playback on or off for the Left Hand Part, to which you can assign the desired channel on the Song Setting display (page 82).
Right	Turns playback on or off for the Right Hand Part, to which you can assign the desired channel on the Song Setting display (page 82).
Guide	Turns the Guide function on or off. For details, refer to the Owner’s Manual.
AB	Turns Repeat playback on or off and lets you specify the Repeat playback range. For details, refer to the Owner’s Manual.

View Setting

From the display called up via  (View Setting), you can set the parameters related to the view of the notation.

Size	Determines the display resolution (or zoom level) of the notation.
Left	Turns indication of the left-hand notation on or off. If an “-” indication appears at this parameter and is unavailable, go to the “Detail Setting” display (page 19), then set the Left Ch to any channel except “Auto.” Or, on the display called up via [Menu] → [SongSetting] → [Part Ch], then set the Left to any channel except “Off” (page 82). NOTE Both Right (below) and Left cannot be turned off at the same time.
Right	Turns indication of the right-hand notation on or off. NOTE Both Right and Left (above) cannot be turned off at the same time.
Chord	Turns indication of the chords on or off. If the current Song does not contain chord data, no chord information is shown even if this is checked.
Lyrics	Turns indication of the Lyrics on or off. If the current Song does not contain lyrics data, no lyrics are shown even if this is checked. If the Song contains Pedal events, touching here switches between “Lyrics” and “Pedal.” When “Pedal” is checked, Pedal events are shown instead of Lyrics on the display.
Note	Turns indication of the Note names on or off. When this is checked, each note name is shown at the left side of each note. If the Song contains Fingering events, touching here switches between “Note” and “Fingering.” When “Fingering” is checked, Fingering events are shown instead of Note names on the display.
Color	When this is checked, the notes in the display appear in identifying colors (C: red, D: yellow, E: green, F: orange, G: blue, A: purple, and B: gray).

Detail Setting

From the display called up via  (Detail Setting), you can set more detailed parameters.

Right Ch	<p>Determines which MIDI channel in the MIDI Song data is used for the right-hand/left-hand part. This setting returns to “Auto” when a different Song is selected.</p> <ul style="list-style-type: none"> • Auto: The MIDI channels in the MIDI Song data for the right- and left-hand parts are assigned automatically — setting each part to the channel which has been specified at the Part Ch (page 82) on the Song Setting display. • 1–16: Assigns a specified MIDI channel (1–16) to each of the right- and left-hand parts. • Off (Left Ch only): No channel assignment. This disables display of the left-hand notation.
Left Ch	
Key Signature	Lets you enter the Key Signature at the current stopped position of the MIDI Song. This setting is useful for Songs you’ve recorded with key changes, so the key signature changes are properly reflected in the notation.
Quantize	This gives you control over the note resolution in the notation, letting you shift or correct the timing of all displayed notes so that they line up to a particular note value. Make sure to select the smallest note value used in the Song.
Note Name	<p>Selects the type of the note name indicated at the left of the note in the notation from among the following three types. The settings here are available when the Note parameter (page 19) is checked.</p> <ul style="list-style-type: none"> • A, B, C: Note names are indicated as letters (C, D, E, F, G, A, B). • Fixed Do: Note names are indicated in solfeggio and differ depending on the selected language. • Movable Do: Note names are indicated in solfeggio according to the scale intervals, and as such are relative to the key. The root note is indicated as Do. For example, in the key of G major the root note of “Sol” would be indicated as “Do.” As with “Fixed Do,” the indication differs depending on the selected language.

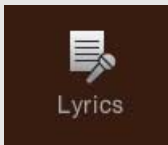

Editing Lyrics Display Settings

Select a MIDI Song, and then touch [Lyrics] to call up the lyrics of the current MIDI Song. You can change the lyrics indication as desired to suit your personal preferences.

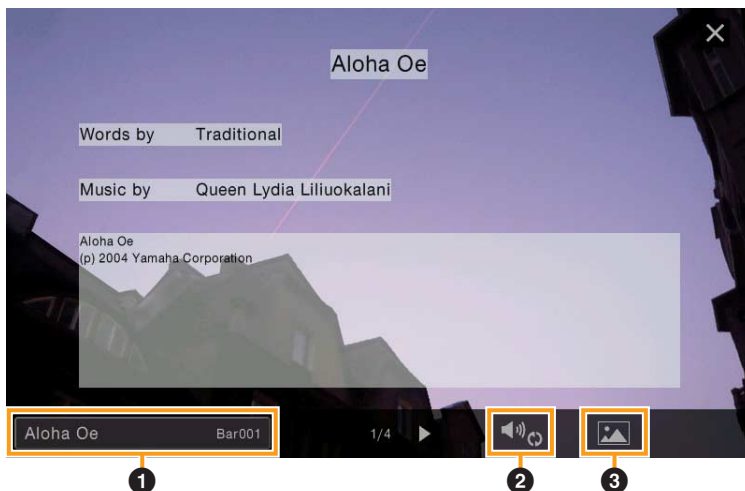

❶	Indicates the name of the current Song. Also, the current measure number is shown at the right end. If you want to change the Song, touch the Song name here to call up the Song Selection display.
❷	Lets you set the parameters related to playback Parts of the MIDI Song. For details, refer to “Play Setting” (page 18).
❸	Allows you to change the background picture of the Lyrics display and Text display. As well as various pictures provided in the Preset tab, you can select an original picture file (a bitmap file with no greater than 800 x 480 pixels) in the USB flash drive. The original picture file can be copied from the USB flash drive to the internal User memory. NOTE The setting here is applied also to the Text display.

NOTE When the lyrics are garbled or unreadable, you may need to change the Lyrics Language setting on the display called up via [Menu] → [SongSetting] → [Lyrics].

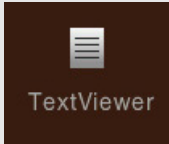

Showing the Text Display and Editing Text Display Settings

You can view the text file (.txt) created by using a computer on the instrument's display. This feature enables various useful possibilities, such as the showing of lyrics, chord names, and text notes.

Showing the Text Display

If you want to view the text in a USB flash drive, connect the USB flash drive containing text data to the [USB TO DEVICE] terminal beforehand.

1 Call up the Text display via [Menu] → [TextViewer].

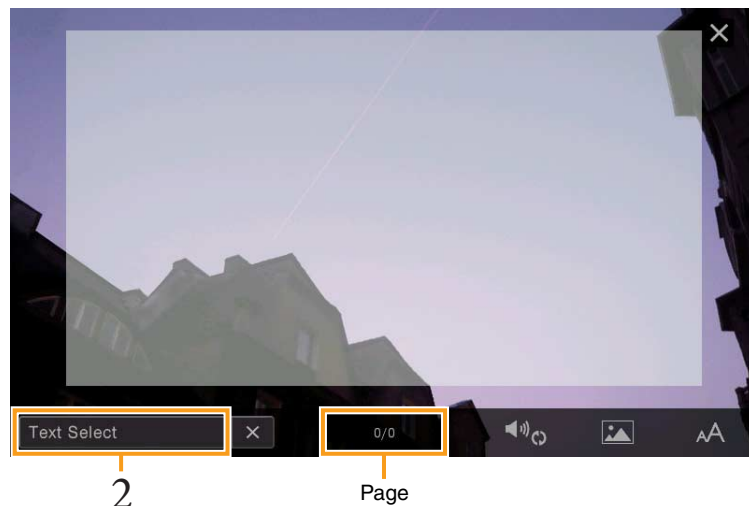

2 Touch the bottom left corner on the display to call up the Text File Selection display.

3 Select the desired text file, and touch [Close] to show the text in the display.

If the text extends over several pages, you can scroll through the entire text by touching [◀] or [▶], which are shown at the right and left of the page. To clear the text from the display, touch [×] located at right of the text file name.

- NOTE**
- Line breaks are not automatically entered in the instrument. If a sentence is not displayed in its entirety because of limitations in the screen space, enter line breaks manually on your computer by using a text editor, etc. beforehand.
 - The Text can be displayed on an external monitor or television. For details on instructions, refer to the Owner's Manual.
 - Information about Text File selection can be memorized to the Registration Memory. For details, refer to the Owner's Manual.
 - You can change the page by flicking horizontally on the display.

Editing Text Display Settings

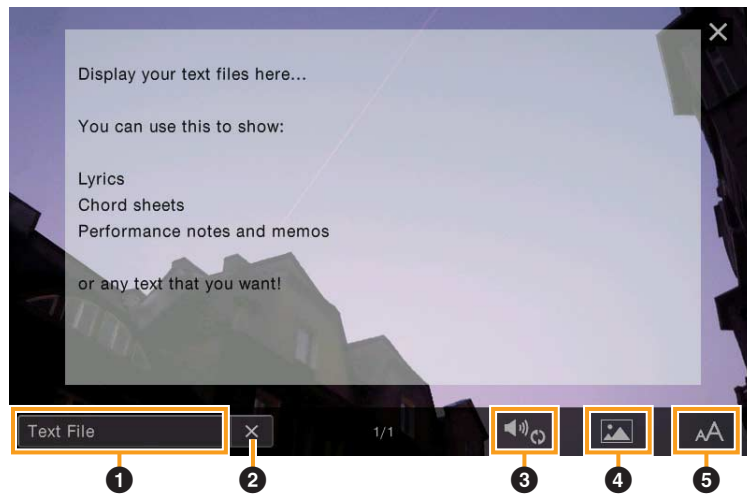

1	Indicates the current text file which is shown on the display. Touching here calls up the text File Selection display which lets you select an original text file in the USB flash drive or copy it from the USB flash drive to the internal User memory.
2	Clears the text from the display. This operation does not delete the text file itself, but simply leaves the display empty of any text file.
3	Lets you set the parameters related to playback Parts of the MIDI Song. For details, refer to “Play Setting” (page 18).
4	Allows you to change the background picture of the Lyrics display and Text display. As well as various pictures provided in the Preset tab, you can select your original picture file (a bitmap file with no greater than 800 x 480 pixels) in the USB flash drive. Your original picture file can be copied from the USB flash drive to the internal User memory. NOTE The setting here is applied also to the Lyrics display.
5	Lets you select the font size or type. “Small,” “Medium,” or “Large” keeps each character at the same width, and is suitable for displaying lyrics with chord names above, etc. “Proportional Small,” “Proportional Medium,” and “Proportional Large” are suitable for displaying lyrics without chord names or explanatory notes.

NOTE When the text is garbled or unreadable, you may need to change the language setting on the display called up via [Menu] → [Utility] → [System].



Using Keyboard Harmony

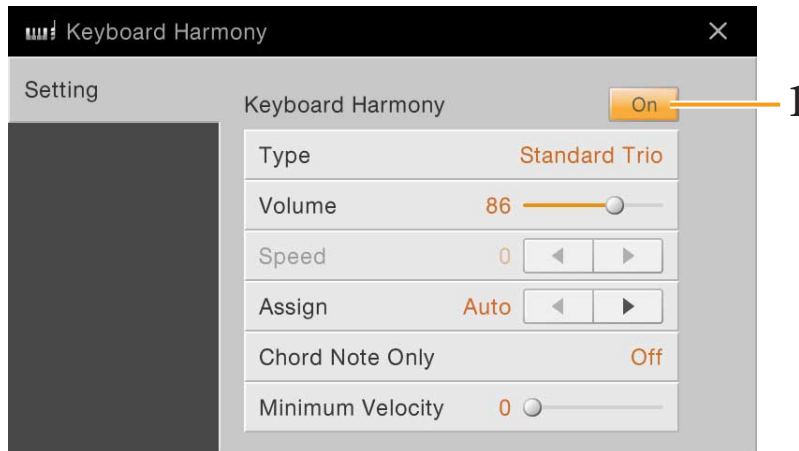

1 Set the Keyboard Harmony function to “On.”

When this is set to “On,” Harmony or Echo is applied to your keyboard performance automatically.

2 Adjust related parameters such as Harmony type and volume.

NOTE The available parameters differ depending on the Harmony type.

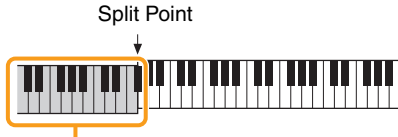
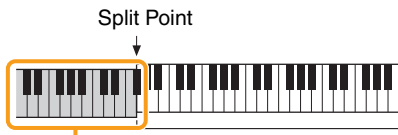
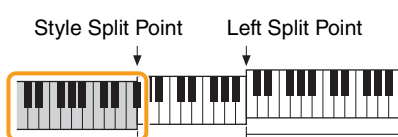
Type	<p>Lets you select one of the Harmony types, which are divided into the following groups.</p>
	<p>■ Harmony Type (Standard Duet — Strum)</p> <p>These types apply the harmony effect to notes played in the right-hand section of the keyboard according to the chord specified in the left-hand section of the keyboard. (Note that the “1+5” and “Octave” settings are not affected by the chord.)</p> <p>If you want to use these types with the Style stopped, set the “Stop ACMP” parameter (page 78) to a setting other than “Disabled.”</p> <p>When [ACMP ON/OFF] is turned on:</p>  <p>Split Point</p> <p>Chord section for Style playback and Harmony effect</p> <p>When the Left part is on:</p>  <p>Split Point</p> <p>Left Voice and chord section for Harmony effect</p> <p>Main and Layer Voices</p> <p>When [ACMP ON/OFF] and the Left part are on:</p>  <p>Style Split Point Left Split Point</p> <p>Left Voice Main and Layer Voices</p> <p>Chord section for Style playback and Harmony effect</p>

Type	<p>■ Multi Assign The Multi Assign effect automatically assigns notes played simultaneously on the right-hand section of the keyboard to separate parts (Voices). Both of the keyboard parts [Main] and [Layer] should be turned on when using the Multi Assign effect. The Main and Layer Voices are alternately assigned to the notes in the order you play.</p> <p>■ Echo Type (Echo, Tremolo and Trill) When one of the Echo Types is selected, the corresponding effect (echo, tremolo, trill) is applied to the note played in the right-hand section of the keyboard in time with the currently set tempo, regardless of the [ACMP ON/OFF] and the Left part on/off status. Keep in mind that Trill only works when you hold down two notes on the keyboard simultaneously (last two notes if more than two notes are held), and it plays those notes alternately.</p>
Volume	This parameter is available for all types with the exception of “Multi Assign.” It determines the level of the harmony/echo notes generated by the Harmony/Echo effect.
Speed	This parameter is only available when Echo, Tremolo, or Trill is selected in Type above. It determines the speed of the Echo, Tremolo, and Trill effects.
Assign	<p>This parameter is available for all types with the exception of “Multi Assign.” This lets you determine the keyboard part via which the harmony/echo notes will be sounded.</p> <ul style="list-style-type: none"> • Auto: Applies the effect to the part which is turned on. When the both parts are on, the Main part is given priority over the Layer part. • Multi: When both parts are on, the note played on the keyboard is sounded by Main part and the harmonies (effect) are divided to the Main and Layer parts. When only one part is on, the note played on the keyboard and effect are sounded by that part. • Main, Layer: Applies the effect to the selected part (Main or Layer).
Chord Note Only	This parameter is available when one of the Harmony Types is selected. When this is set to “On,” the Harmony effect is applied only to notes (played in the right-hand section of the keyboard) that belong to a chord played in the chord section of the keyboard.
Minimum Velocity	This parameter is available for all types with the exception of “Multi Assign.” It determines the lowest velocity value at which the harmony note will sound. This allows you to selectively apply the harmony by your playing strength, letting you create harmony accents in the melody. The harmony effect is applied when you play the key strongly (above the set value).



Microphone Settings

This section lets you set parameters for various Effects that are applied to the microphone sound. You should make both “Vocal” and “Talk” settings — “Vocal,” for your singing performance, and “Talk,” for making announcements between songs, for example.

NOTE These settings allow you to adjust EQ, Noise Gate and Compressor when “Vocal” is selected. To adjust Pan and Reverb/Chorus settings for your singing voice, use the Mixer settings (page 14).

When “Vocal” is selected:

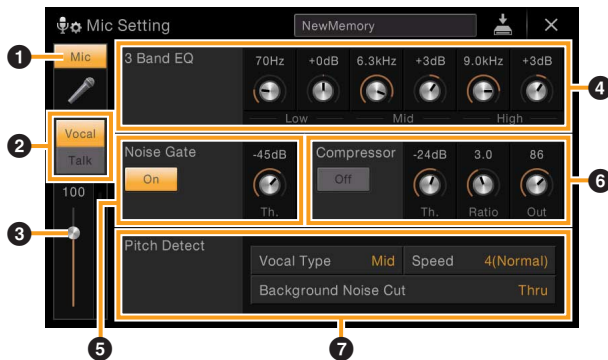

When “Talk” is selected:



1	Microphone On/Off	Turns on or off the microphone sound. When set to On, the microphone sound will be input to the instrument. NOTE The setting here is equivalent to that in the Vocal Harmony display (page 27).
2	Vocal/Talk Switch	When you sing into the microphone for your performance, set this to “Vocal.” When you talk normally or need to make announcements between songs of your performance, set this to “Talk.” This lets you instantly change the microphone settings depending on the situation. NOTE The setting here is equivalent to that in the Vocal Harmony display (page 27).
3	Volume Adjustment	Adjusts the input volume of the microphone sound. The input level is shown at the right. NOTE The setting here is equivalent to that in the Vocal Harmony display (page 27).
4	3 Band EQ	EQ (Equalizer) is a processor that divides the frequency spectrum into multiple bands which can be boosted or cut as required to tailor the overall frequency response. The instrument features a three-band (Low, Mid and High) digital equalizer function for the microphone sound. For each of three bands, you can adjust the center frequency (Hz) and level (dB) via the corresponding knobs on the display.
5	Noise Gate	This effect mutes the input signal when the input from the microphone falls below a specified level. This effectively cuts off extraneous noise, allowing the desired signal (vocal, etc.) to pass.
	On/Off	Turns Noise Gate on or off.
	Th. (Threshold)	Adjusts the input level above which the gate begins to open.
6	Compressor	This effect holds down the output when the input signal from the microphone exceeds a specified level. This is especially useful for smoothing out vocals that have widely varying dynamics. It effectively “compresses” the signal, making loud parts softer, or vice versa.
	On/Off	Turns Compressor on or off.
	Th. (Threshold)	Adjusts the input level above which compression begins to be applied.
	Ratio	Adjusts the compression ratio. Higher ratios result in a more compressed sound, with a reduced dynamic range.
	Output	Adjusts the final output level.

⑦	Pitch Detect (only when “Vocal” is selected)	Lets you set how the pitch of the microphone sound during performance is detected.	
		Vocal Type	Set this to obtain the most natural vocal harmony, depending on your voice. <ul style="list-style-type: none"> • Low: Setting for lower voices. This setting is also appropriate for growling and shouting. • Mid: Setting for mid-range voices. • High: Setting for higher voices. This setting is also appropriate for singing close to the microphone. • Full: Setting for vocalists having a wide range, from low to high.
		Speed	Adjusts the response speed of the Vocal Harmony effect, or how quickly harmonies are generated in response to your voice. The larger the number, the faster the response. NOTE When one or both of Lead Pitch Detect Speed and Harm Pitch Detect Speed parameters of Vocal Harmony (page 30) are set to “as MIC SETTING,” this parameter is effective. In other settings, the setting of the Vocal Harmony’s Pitch Detect Speed is effective.
		Background Noise Cut	This allows you to filter out noises that would interfere with the pitch detection. A setting of “Thru” turns the noise filter off.
⑧	Talk Mixing (only when “Talk” is selected)	Lets you make settings for talking or making announcements between songs during a performance.	
		Pan	Determines the stereo pan position of the microphone sound.
		Reverb Depth	Determines the depth of the reverb effects applied to the microphone sound.
		Chorus Depth	Determines the depth of the chorus effects applied to the microphone sound.
		Attenuator	Determines the amount of reduction to be applied to the overall sound (excepting the microphone input) — allowing you to effectively adjust the balance between your voice and the overall instrument sound.

NOTICE

The settings here are lost if you turn off the power without executing the Save operation.

Storing the Microphone Settings

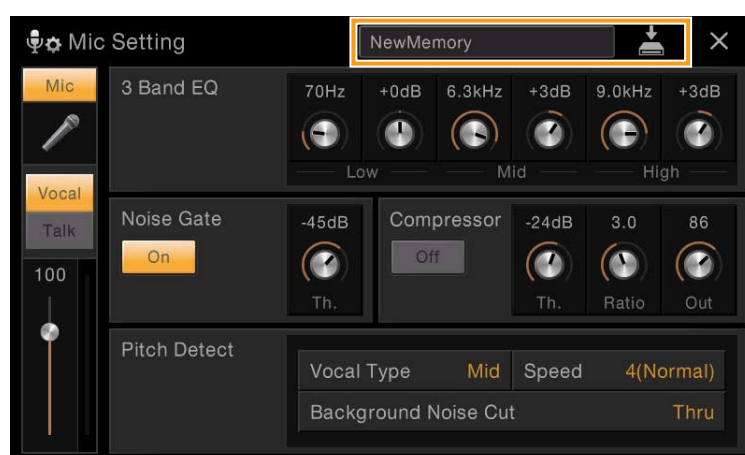

You can store the microphone settings by touching  (Save) then selecting one of 10 User Memories. For ease in future recall, you should assign a sufficiently descriptive name or one that matches your performance.

To call up the microphone settings, touch the setting name at left of  (Save) then select the desired file.

NOTE If you want to save the microphone settings to a USB flash drive, save as a User Effect file. To do this, on the display called up via [Menu] → [Utility] → [Factory Reset/Backup] → page 2/2, touch [Backup] of “User Effect” to execute the Save operation (page 99).



Vocal Harmony Settings

This section allows you to set various Vocal Harmony parameters, even though just selecting a Vocal Harmony Type will call up the appropriate settings and you need not edit these parameters normally. If you want to make more detailed settings for your performance, read this chapter.

Basic Parameters

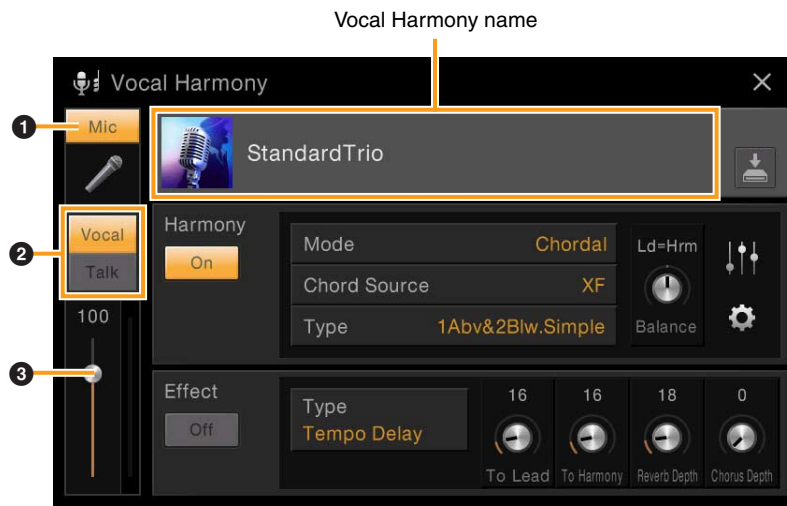

❶	Microphone On/Off	Turns the microphone sound on or off. When this is set to On, the microphone sound is input to the instrument.
❷	Vocal/Talk Switch	When you sing into the microphone, this should be set to “Vocal.” When you talk normally or make announcements between songs, this should be set to “Talk.” If you want to set the Vocal Harmony parameters, this should be set to “Vocal.”
❸	Volume Adjustment	Adjusts the input volume of the microphone sound. The input level is shown at the right.

NOTE The settings here are equivalent to those in the Microphone Setting display ([page 25](#)).

Editing the Vocal Harmony Type

By editing the parameters of the preset Vocal Harmony type, you can create your original Vocal Harmony type.

- 1 Touch the Vocal Harmony name to call up the Vocal Harmony Selection display.
- 2 Select the desired Vocal Harmony type.
- 3 Depending on the selected Vocal Harmony type, edit the relevant settings as desired.

When the Mode (2) is set to "Chordal":

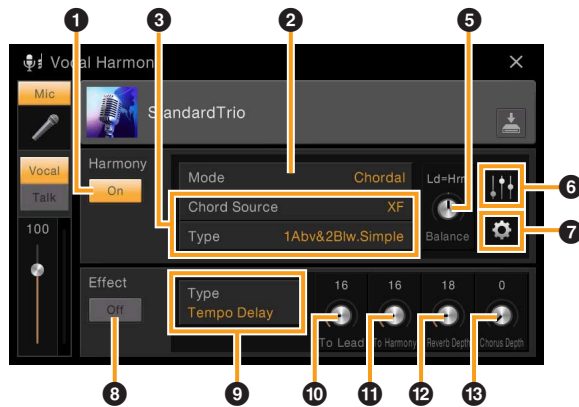

When the Mode (2) is set to "Vocoder" or "Vocoder-Mono":

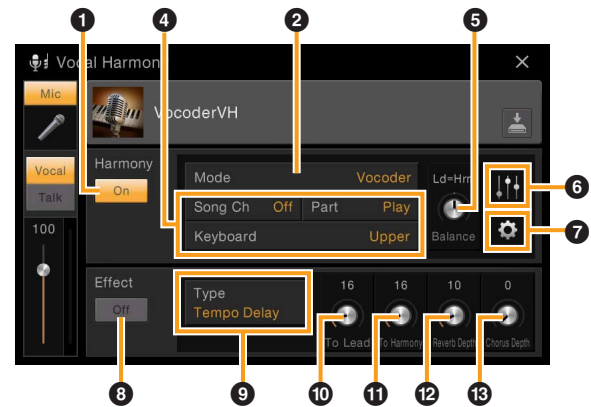

■ Harmony

Lets you edit the Vocal Harmony parameters.

1	Harmony On/Off	Turns Vocal Harmony on or off.	
2	Mode	Although one of the three following Modes is automatically selected when a Vocal Harmony type is selected, you can change the Mode.	
		Chordal	The harmony notes are determined by the following three chord types: chords played in the chord section of the keyboard (with [ACMP ON/OFF] turned on), chords played in the left hand section of the keyboard (with the Left part turned on), and chords contained in Song data for controlling the harmony. (Not available if the Song does not contain any chord data.) NOTE If you want to apply Vocal Harmony by pressing the chords in the chord section when the Style is stopped, you need to set the "Stop ACMP" parameter to a setting other than "Disabled" in the Style Setting display (page 78).
		Vocoder	The microphone sound is output via the notes you play on the keyboard or via the Song playback notes.
	Vocoder-Mono	Basically the same as the Vocoder. In this mode, only single-note melodies or lines can be played back (with last-note priority).	
3	(When the Mode is set to "Chordal")		
	Chord Source	Determines which data or event of a Song will be used for chord detection. <ul style="list-style-type: none"> • Off: Detects no chord from the Song data. • XF: Chord data defined via XF will be used. • 1 – 16: Detects a chord from notes of the MIDI channel specified here. 	

③	Type	<p>Determines how the harmony notes are applied to the microphone sound by selecting one of the Chordal Types. Almost all Types apply the harmony notes based on the chord specified via the left hand section of the keyboard, chord section of the keyboard, or the Song data, with the exception of the following two Types.</p> <ul style="list-style-type: none"> • ScaleDiatonic: This generates harmony notes based on the Key Root and Key Type specified in the Harmony Assign display (⑦), meaning that the harmony notes do not depend on the chord but match the diatonic scale of the current song's key signature. • Parallel: This adds a note to the lead note (microphone sound) with the interval specified at ⑥, regardless of the chord. <p>NOTE "Abv" in the Chordal Type List means that the harmony notes are generated above the lead note (microphone sound) while "Blw" means that the harmony notes are generated below the lead note.</p> <p>For more information about the Chordal Types, refer to the "MIDI Reference" (Vocal Harmony Parameter List) on the website.</p>
④	(When the Mode is set to "Vocoder" or "Vocoder -Mono")	
	Song Ch	When set to one of 1 – 16, note data (played from a Song on this instrument or the connected computer) of the corresponding channel is used to control the harmony. When set to "Off," Song data control over harmony is turned off.
	Part	When set to "Mute," the channel selected above (to control Harmony) is muted (turned off) during Song playback, allowing you to disable control via specific channels as desired.
	Keyboard	<ul style="list-style-type: none"> • Off: Keyboard control over harmony is turned off. • Upper: Notes played to the right of the Split Point control the harmony. • Lower: Notes played to the left of the Split Point control the harmony.
⑤	Balance	Lets you set the balance between the lead vocal (the microphone sound) and Vocal Harmony sound. Raising this value increases the volume of the Vocal Harmony and decreases that of the lead vocal. When this is set to L<H63 (L: Lead Vocal, H: Vocal Harmony), only the Vocal Harmony is output; when it is set to L63>H, only the lead vocal is output.
⑥	Balance adjustment for each Lead note and Harmony note	<p>The following parameters can be adjusted for each Lead note (microphone sound) and Harmony note.</p> <ul style="list-style-type: none"> • Transpose/Degree: Lets you shift the pitch for each Harmony note and Lead note. The range for all notes is the same; however, the lead note can only be adjusted in octaves. When the Chordal Type is set to "ScaleDiatonic," this parameter changes to Degree, letting you shift the pitch in degree from -3 octaves (-22 scale degrees) – Unison (1 scale degree) – +3 octaves (+22 scale degrees). • Detune: Determines the fine pitch setting for each Harmony note from -50 cents to +50 cents. • Formant: Determines the formant setting for each Harmony note. The higher the value, the more "feminine" the harmony voice becomes. The lower the value, the more "masculine" the voice. • Pan: Determines the pan position setting for each Harmony note. Setting each Harmony note to a different pan position, with the Lead vocal at center, for example, results in a naturally wide stereo sound. • Volume: Determines the volume setting for each Harmony note. Use this to adjust the relative level balance among the Lead vocal and the Harmony notes. <p>NOTE When Pitch Correct Mode (⑦) is set to OFF the Lead part is not available for the Transpose/Degree, Detune and Formant parameters.</p> <p>NOTE The Transpose values of the Harmonies are available only when the Mode (②) is set to "Chordal."</p>

7	Harmony Assign	<p>Lets you set how the Harmony notes are assigned or voiced to the Lead note (microphone sound). For details, refer to the “MIDI Reference” (Vocal Harmony Parameter List) on the website.</p> <p>■ When the Harmony mode is set to “Chordal”</p> <ul style="list-style-type: none"> • Session Table: Determines how the harmonies will be voiced, or what type of chord will be used in creating the harmonies, according to different musical styles. • NOTE This parameter is available only when the Chordal Type is set to something other than ScaleDiatonic or Parallel. • Key Root, Key Type: When the Chordal Type (🔊) is set to “ScaleDiatonic,” this parameter is available. Harmony notes based on the settings here do not depend on the chord but match the diatonic scale of the current song’s key signature. <p>■ When the Harmony mode is set to “Vocoder” or “Vocoder-Mono”</p> <ul style="list-style-type: none"> • Transpose Mode: Determines the amount by which the harmony parts are transposed. A setting of “0” results in no transposition, while the “Auto” setting results in automatic transposition.
	Detail Setting	<ul style="list-style-type: none"> • Pitch Correct Mode: Corrects the pitch of the Lead note (microphone sound). “Off” does not correct while “Hard” corrects the pitch most accurately. • Humanize: This setting allows you to make the Vocal Harmony sounds more natural and less “electronic,” by introducing slight time discrepancies between the Lead and Harmony notes. <ul style="list-style-type: none"> Off: No Humanize effect. 1: The Humanize effect is applied to the Harmony to create a more natural feel, with an authentic-sounding widening effect, giving the impression of more people singing. 2: The Humanize effect is applied to the Harmony to produce a more distinct groove. Even faster passages retain their rhythmic essence. 3: The Humanize effect is applied to the Harmony to reflect the way in which the lead vocalist and back chorus interact, with the lead vocal out front, and the timing slightly relaxed. • Lead Pitch Detect Speed, Harm Pitch Detect Speed: Determines how fast the pitch of the Lead note and the harmony notes are detected in response to the signal via the microphone. “1” responds most slowly, “4” is standard, “15” responds most quickly, and “as MIC SETTING” gives priority to the speed specified at the Pitch Detect “Speed” of the Microphone Setting display (page 26). • Harmony Effect: Determines the Effect type applied to the Harmony notes added to the Lead note. • Harmony Stability: Determines the stability degree to which the Harmony is applied to the Lead note. When set to “Stable,” this has a relatively stable sound with little harmony motion. When set to “Dynamic,” this tends to add harmony with motion according to the input sound. • Lead Vibrato Depth: This specifies the vibrato depth of the lead sound. • Harm Vibrato Depth: This specifies the vibrato depth of the harmony sound. • Vibrato Speed: This specifies the vibrato speed of both the lead and harmony sounds. • Vibrato Delay: This specifies the vibrato delay of both the lead and harmony sounds. <p>For more information about the parameters of Detail Settings, refer to “MIDI Reference” (Vocal Harmony Parameter List) on the website.</p>

■ Effect

Lets you edit the parameters related to the Effects applied to the Vocal Harmony notes.

8	Effect On/Off	Turns on or off the Effects applied to the Vocal Harmony notes.
9	Type	Selects the Effect type applied to the Vocal Harmony notes. You can edit also the detailed parameters of the selected type. For information about the Vocal Harmony Effect types, refer to the “Data List” (Vocal Effect Type List). For information about the Vocal Harmony Effect parameters, refer to the “MIDI Reference” (Vocal Harmony Parameter List) on the website.
10	To Lead	Adjusts the Effect depth applied to the Lead note.

11	To Harmony	Adjusts the Effect depth applied to the Harmony notes.
12	Reverb Depth	Adjusts the Reverb depth applied to the microphone sound. This setting is equivalent to that in the Mixer display (page 14).
13	Chorus Depth	Adjusts the Chorus depth applied to the microphone sound. This setting is equivalent to that in the Mixer display (page 14).

4 Touch (Save), then save the edits as an original Vocal Harmony type.

Up to 60 Vocal Harmony types can be saved to User memory. For ease in future recall, you should assign a descriptive name that matches the settings.

NOTICE

The settings here are lost if you turn off the power without executing the Save operation.

NOTE If you want to save the Vocal Harmony settings to a USB flash drive, save as a User Effect file. To do this, on the display called up via [Menu] → [Utility] → [Factory Reset/Backup] → page 2/2, touch [Backup] of "User Effect" to execute the Save operation ([page 99](#)).



Creating/Editing Music Finder Records

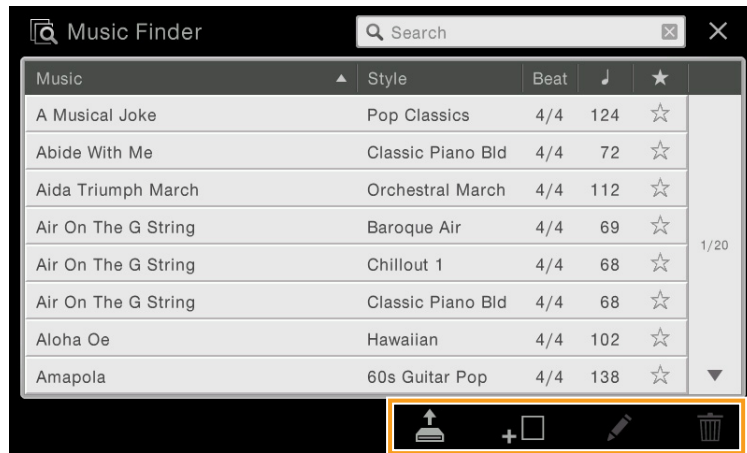

Creating/Editing a Record

You can create a new Record or edit the currently selected Record.

1 If you want to edit the existing Record, select the desired Record on the Music Finder display. This operation is not necessary when you create a new Record from scratch.

2 Call up the operation display.

If you want to create a new Record from scratch, touch (Create). If you want to edit an existing Record, touch (Edit).

3 Create a new Record or Edit the current Record.

To create a new Record:

Create Record	
Music	
Style	PRESET:/Pop&Rock/Pop/ Standard 8Beat
Beat	4/4
Tempo	120
Section	Intro2 ▶ Main A
Genre	ANY
Keyword	
<input type="button" value="Cancel"/> <input type="button" value="Create"/>	

To edit the current Record:

Edit Record	
Music	A Musical Joke
Style	PRESET:/Entertainment/Easy Listening/ Pop Classics
Beat	4/4
Tempo	124
Section	Intro2 ▶ Main A
Genre	Classical
Keyword	classical
<input type="button" value="Cancel"/> <input type="button" value="Save"/>	

Music	Lets you enter the music title or Record name which will be shown on the Music Finder display.
Style	Lets you enter the desired Style. This is not available for Song Records.

Beat	Lets you enter the desired Beat which will be used for sorting the Records. This is not available for Song Records. NOTE The setting here is just for sorting the Records, and does not affect the actual beat of the specified Style.
Tempo	Lets you enter the actual Tempo value. This is not available for Song Records.
Section	Lets you specify the Style Section setup which will be called up when this Record is selected. This is not available for Song Records.
Genre	Lets you select the desired genre.
Keyword	Lets you enter the keyword for searching the Records.

If you want to abort your edits, touch [Cancel].

4 Touch [Create] or [Save] to save the created/edited Record.

Touching [Create] will add the new created Record to the Music Finder display. Touching [Save] will overwrite your edits to the existing Record.

Registering a Song or Style to a Record

By registering Song or Style files in various locations (Preset, User and USB) into Music Finder, you can easily call up your favorite files.

NOTE If you want to register files in a USB flash drive, connect the USB flash drive containing the data to the [USB TO DEVICE] terminal.

1 In the Song or Style Selection display, select the desired file.

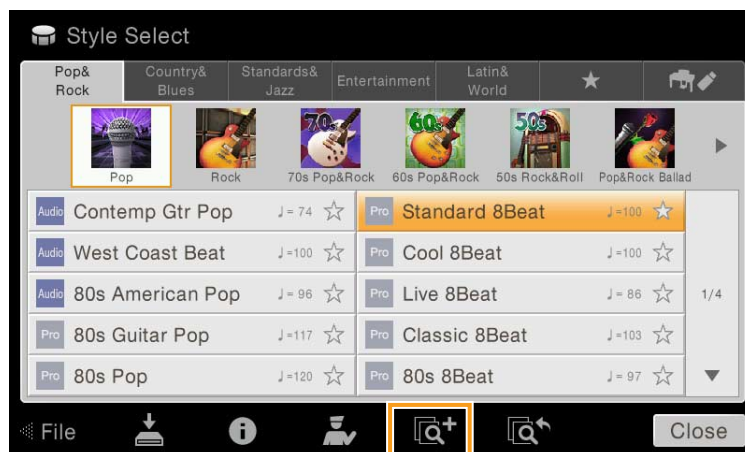

2

2 Touch (Add) to call up the Create Record display.

As necessary, you can change the Music title and keyword, etc. (page 32).

NOTE To cancel the operation, touch [Cancel].

3 Touch [Create] to create a new Record to which the Song or Style selected in step 1 is registered.

4 Check that the created Record is shown in the Music Finder display.

In the “Style” column of the Record to which the Song is registered, “(MIDI Song)” or “(Audio Song)” is shown.

Calling up the Song or Style registered to Music Finder

You can call up the registered Song or Style in the same way as the other records. Refer to the Owner's Manual for details.

NOTE If you register a Song or Style in the USB flash drive to a Record, make sure to connect the same USB flash drive to the [USB TO DEVICE] terminal when you call it up via the Music Finder Record.

Deleting a Record

- 1 From the Music Finder display, select a Record to be deleted.
- 2 Touch  (Delete) to delete the selected Record.

Saving the Records as a Single File

The Music Finder feature handles all the Records including the presets and additionally created records as a single file. Keep in mind that individual records (panel settings and Song data) cannot be handled as separate files.

- 1 As necessary, connect a USB flash drive to this instrument.
- 2 Call up the operation display via [Menu] → [Utility] → [Factory Reset/Backup] → page 2/2.
- 3 Touch [Backup] of “Music Finder” to call up the File Selection display.
- 4 Select the location to which you want to save the file, then touch [Backup Here] to execute the Save operation.

All Records are saved together as a single file.

Calling Up Music Finder Records from User memory/USB flash drive

- 1 On the Music Finder display, touch  (Load) to call up the File Selection display.

NOTE This display can also be called up by touching [Restore] of “Music Finder” at the display called up via [Menu] → [Utility] → [Factory Reset/Backup] → page 2/2.

- 2 Select a Music Finder file on the internal User memory or USB flash drive.

The confirmation dialog appears as follows:

- **Append:** The Records in the selected file will be added to the existing Records.
- **Replace:** The existing Records will be replaced with the Records in the selected file.
- **Cancel:** Aborts the operation (the selected file is not called up).

NOTICE

Selecting “Replace” automatically deletes all your original Records from internal memory. Make sure that all the Records including the important ones have been saved to a single file.

NOTE When you want to restore the initial default status, select “MusicFinderPreset” in the Preset tab then touch [Replace].



Calling Up Registration Memory Numbers in Order (Registration Sequence)

For changing the panel setup quickly during a live performance, this instrument features the Registration Sequence which lets you call up the eight setups in any order you specify, by simply using the ASSIGNABLE buttons or the pedal as you play.

- 1 On the Home display, touch [▶] at the upper right corner to show the Registration area, then touch the area to call up the Registration Bank Selection display.

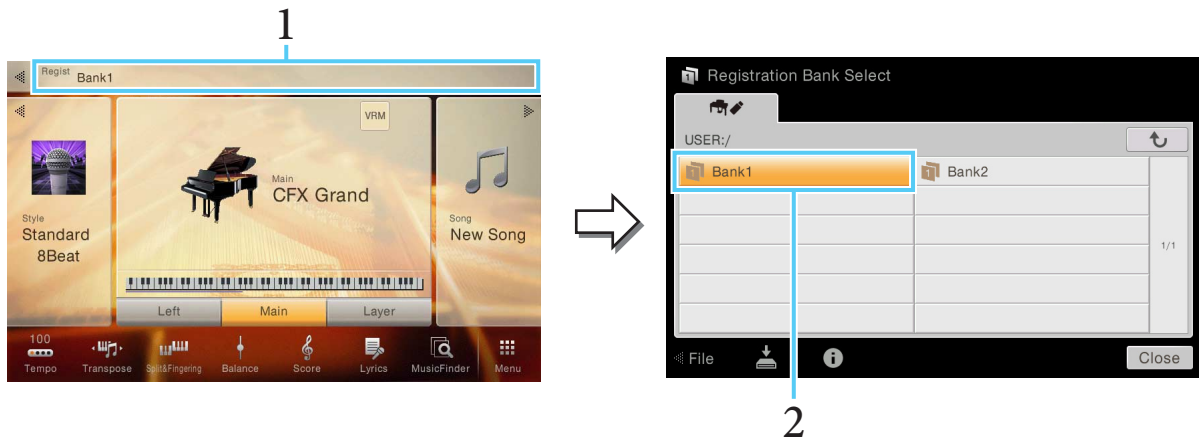

- 2 Select the desired Registration Memory Bank to create a sequence.
- 3 Call up the Registration Sequence display via [Menu] → [RegistSeq].

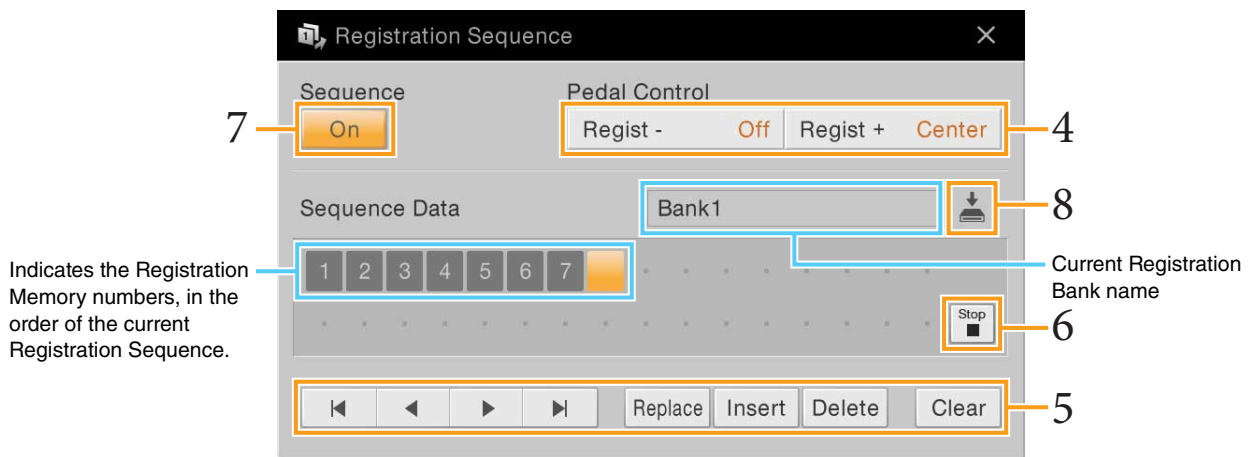

- 4 If you intend to use a pedal to switch the Registration Memory number, specify here how the pedal will be used.

The pedal assigned to “Regist +” will be used for advancing through the sequence. The pedal assigned to “Regist -” will be used for reversing through the sequence.

NOTE You can also assign the other functions to the pedal — Punch In/Out of Song (page 83) and the function set in the Assignable display (page 38). If you assign multiple functions to the pedal, the priority is: Punch In/Out of Song → Registration Sequence → the function set in the Assignable display.

If you intend to use the ASSIGNABLE button to switch the Registration Memory number, assign “Regist +” or “Regist -” in the display called up via [Menu] → [Assignable] → [Assignable] (page 41).

5 Program a Sequence order in which the Registration Memory number is to be called up.
 Basically, press the desired Registration Memory number button on the panel, then touch [Insert] to enter the selected number.

◀, ◀, ▶, ▶	Moves the cursor. NOTE If you want to move the cursor directly to an already entered number, touch the desired number.
Replace	Replaces the number of the cursor location with the currently selected Registration Memory number.
Insert	Inserts the number of the currently selected Registration Memory number before the cursor position.
Delete	Deletes the number at the cursor position.
Clear	Deletes all numbers in the sequence.

6 Select the action that will result when the Registration Sequence reaches the end.

- **Stop:** Pressing the ASSIGNABLE button or the “advance” pedal has no effect. The sequence is “stopped.”
- **Top:** The sequence starts again at the beginning.
- **Next:** The sequence automatically moves to the beginning of the next Registration Memory Bank in the same folder.

7 Set the Registration Sequence to “On.”

The Registration Sequence programmed here is shown in the Registration area of the Home display. Press the pedal or the ASSIGNABLE button to check whether or not the Registration Memory number is called up in the order as programmed.

8 Touch  (Save) to call up the File Selection display, then save the sequence program as a Registration Memory Bank file.

NOTICE

Settings in the Registration Sequence display will be lost if you select another Registration Bank without executing the Save operation.



Disabling Recall of Specific Items (Registration Freeze)

Registration Memory lets you recall all the panel setups you made with a single button press. However, there may be times that you want certain items to remain the same, even when switching Registration Memory setups. For example, you may want to switch Voice settings while keeping the same Style. This is where the Freeze function comes in handy. It lets you maintain the settings of certain items and leave them unchanged, even when selecting other Registration Memory buttons.

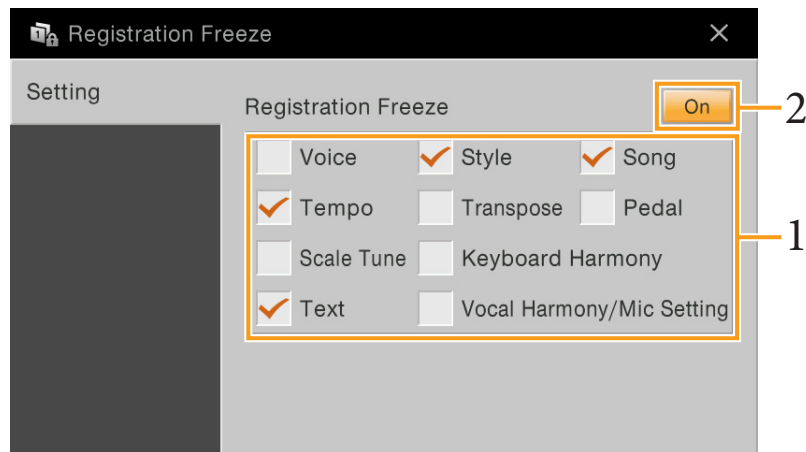

- 1** Enter the checkmark of the item to be “frozen.”
- 2** Set the Registration Freeze to “On.”

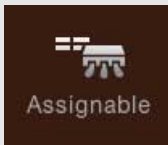

Assigning a Specific Function to Each Pedal or ASSIGNABLE button

Pedal

You can assign various functions to the three pedals of the instrument, instead of the original functions (damper, sostenuto and soft). Likewise, various functions can be assigned to the Footswitch or Foot Controller connected to the [AUX PEDAL] jack.

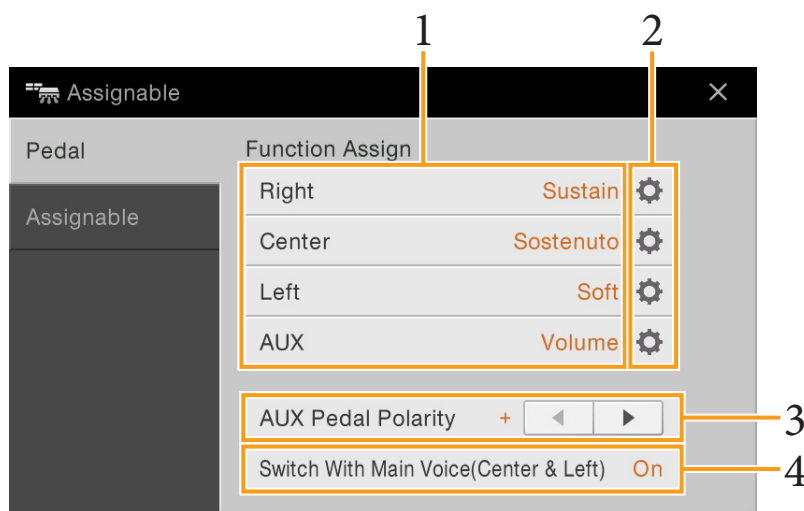

1 Select the function for each pedal.

For information about each function, refer to pages 39 – 40.

NOTE You can also assign other functions to the pedal — Punch In/Out of Song (page 83) and Registration Sequence (page 35). If you assign multiple functions to the pedal, the priority is: Punch In/Out of Song → Registration Sequence → Functions assigned here.

2 Touch (Setting), then make the detailed settings of the selected functions.

For each Part, you can turn on or off the selected function and adjust the degree to which the selected function is applied. Depending on the function selected in Step 1, the available parameters differ, or  (Setting) is grayed out indicating that there is no available parameters.

3 If necessary, set the polarity of the footswitch or foot controller connected to the [AUX PEDAL] jack.

Depending on the Footswitch or Foot Controller, it may work in the opposite way (i.e., pressing it has no effect, but releasing it does). If such a case occurs, use this setting to reverse the polarity.

4 If you change the functions of the Center and Left pedals from the default settings, turn “Switch With Main Voice(Center & Left)” on or off as desired.

When this is set to off, the function assignments of the Center and Left pedals are maintained even if the Main Voice is changed (page 45).

Assignable Pedal Functions

For functions indicated with “*”, use only the Foot Controller; proper operation cannot be done with a Footswitch.
For functions indicated with “**”, they can be assigned also to the ASSIGNABLE [1] – [4] buttons.

Articulation 1/2**	When you use a Super Articulation Voice that has an effect assigned to the pedal/footswitch, you can enable the effect by pressing the pedal/footswitch.
Volume*	Controls the volume. This function is available only for the foot controller connected to the instrument's [AUX PEDAL] jack.
Sustain	Controls the sustain. When you press and hold the pedal, all notes played on the keyboard have a longer sustain. Releasing the pedal immediately stops (damps) any sustained notes. The “Half Pedal Point” parameter allows you to specify how far down you should press on the pedal until the damper effect starts working. This can be set for all pedals on the CVP-709, as well as the right pedal and the foot controller connected to the [AUX PEDAL] jack on the CVP-705.
Sostenuto	Controls the Sostenuto effect. If you play a note or chord on the keyboard and press the pedal while holding the note(s), the notes will sustain as long as the pedal is held. However, all subsequent notes will not sustain. This makes it possible to sustain a chord, for example, while other notes are played staccato. NOTE This function will not affect any of the Organ Flutes and only some of the Super Articulation Voices.
Soft	Controls the Soft effect. Pressing this pedal reduces the volume and changes the timbre of the notes you play. This is effective only for certain appropriate Voices. The “Half Pedal Point” parameter allows you to specify how far down you should press on the pedal until the soft effect starts working. This can be set for all pedals on the CVP-709, as well as the right pedal and the foot controller connected to the [AUX PEDAL] jack on the CVP-705.
Glide	When the pedal is pressed, the pitch changes, and then returns to normal pitch when the pedal is released. <ul style="list-style-type: none"> • Up/Down: Determines whether the pitch change goes up (is raised) or down (is lowered). • Range: Determines the range of the pitch change, in semitones. • On Speed: Determines the speed of the pitch change when the pedal is pressed. • Off Speed: Determines the speed of the pitch change when the pedal is released.
Portamento	The portamento effect (a smooth slide between notes) can be produced while the pedal is pressed. Portamento is produced when notes are played legato style (i.e., a note is played while the preceding note is still held). The portamento time can also be adjusted from the Voice Edit display (page 43). This function does not affect certain Natural Voices, which would not sound appropriately with this function. NOTE This function will not affect any of the Organ Flutes, Super Articulation 2 Voices (CVP-709 only) and only some of the Super Articulation Voices.
Pitch Bend*	Allows you to bend the pitch of notes up or down by using the pedal. This function can be assigned to all pedals on the CVP-709, as well as the right pedal and the foot controller connected to the [AUX PEDAL] jack on the CVP-705. <ul style="list-style-type: none"> • Up/Down: Determines whether the pitch change goes up (is raised) or down (is lowered). • Range: Determines the range of the pitch change, in semitones.
Modulation*	Applies a vibrato effect to notes played on the keyboard. Moreover, various effects can be added to the Super Articulation Voice. The effect becomes deeper when pressing down the foot controller.
Modulation (Alt)	Unlike the Modulation above, pressing the pedal or footswitch alternates the on/off status of the vibrato effect.
Effect Variation On/Off**	Switches the Insertion Effect Variation (page 45) on and off.

Vibe Rotor On/Off**	Switches the Vibe Rotor on and off when the Insertion Effect Type (page 45) is set to “VibeRotor” in the “Legacy” category.
Keyboard Harmony On/Off**	Switches the Keyboard Harmony (page 23) function on and off.
Vocal Harmony On/Off**	Switches “Harmony” in the Vocal Harmony display on and off (page 28).
Vocal Harmony Effect On/Off**	Switches “Effect” in the Vocal Harmony display on and off (page 30).
Talk On/Off**	Switches between “Vocal” and “Talk” in the Microphone Setting display (page 25).
Score Page +/-**	While the Song is stopped, you can turn to the next/previous score page (one page at a time).
Lyrics Page +/-**	While the Song is stopped, you can turn to the next/previous lyrics page (one page at a time).
Text Page +/-**	You can turn to the next/previous text page (one page at a time).
Song Play/Pause	Same as the SONG CONTROL [▶/■] (PLAY/PAUSE) button.
Style Start/Stop	Same as the STYLE CONTROL [▶/■] (START/STOP) button.
Tap Tempo	Same as the [TAP TEMPO] button.
Synchro Start	Same as the [SYNC START] button.
Synchro Stop	Same as the [SYNC STOP] button.
Intro 1 – 3	Same as the INTRO [I] – [III] buttons.
Main A – D	Same as the MAIN VARIATION [A] – [D] buttons
Fill Down	Plays a fill-in, which is automatically followed by the Main section of the button on the immediate left.
Fill Self	Plays a fill-in.
Fill Break	Plays a break.
Fill Up	Plays a fill-in, which is automatically followed by the Main section of the button on the immediate right.
Ending 1 – 3	Same as the ENDING/rit. [I] – [III] buttons.
Fade In/Out**	Switches Fade In /Fade Out function on and off.
Fingered/ Fingered On Bass**	The pedal alternately switches between the Fingered and On Bass modes (page 7).
Bass Hold	While the pedal is pressed, the Style bass note will be held even if the chord is changed during Style playback. If the fingering is set to “AI Full Keyboard,” the function does not work.
Percussion	The pedal plays a percussion instrument selected in the window called up via  (Setting). In this window, you can use the keyboard to select an instrument. NOTE When you select the percussion instrument by pressing a key on the keyboard, the velocity with which you press the key determines the percussion volume.
Main Voice On/Off**	Turns the Main Voice on or off.
Layer Voice On/Off**	Turns the Layer Voice on or off.
Left Voice On/Off**	Turns the Left Voice on or off.
OTS +/-	Calls up the next/previous One Touch Setting.

Assignable

You can assign a specific function to each of the ASSIGNABLE [1] – [4] buttons, letting you call up often used functions quickly. Likewise, you can also assign each of the icons shown in the Menu display to each of these buttons.

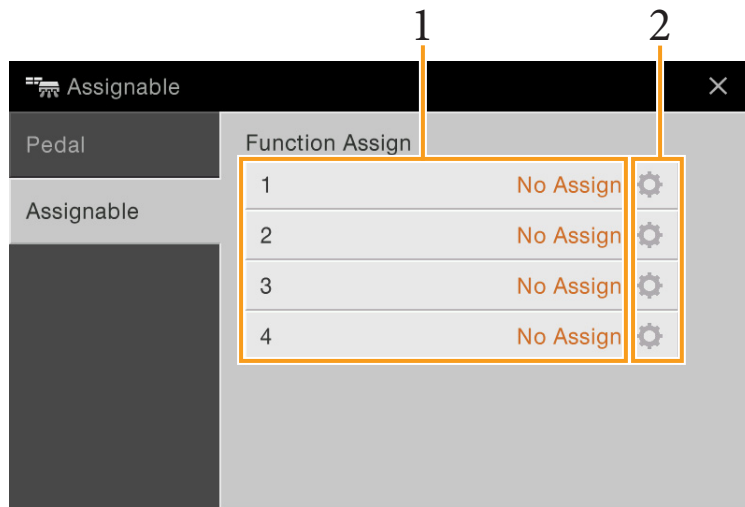

1 Select the item for each of ASSIGNABLE buttons.

You can assign the icons shown in the Menu display (with the exception of Assignable, Wireless LAN and Time), Pedal Functions marked with ** (page 39), and the following functions. If you want no function to be assigned, select “No Assign.”

Left Hold On/Off	Turns on or off the Left Hold.
Effect On/Off	Turns on or off the Effects.
Mono/Poly	Switches between the Mono (in which the Keyboard Voice is played monophonically with the last note priority) and Poly (in which the Keyboard Voice is played polyphonically). Depending on the Voice, Portamento may be produced when notes are played with legato.
Register +/-	Calls up the next/previous Registration Memory number of the Registration Sequence.

2 If necessary, touch (Setting) then make the detailed settings.

You can turn on or off the specified function for each Part. Depending on the selected function,  (Setting) is grayed out, indicating that there are no available parameters.

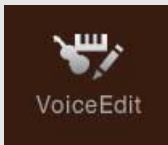

Editing a Voice (Voice Edit)

The Voice Edit feature allows you to create your own Voices by editing some parameters of the existing Voice. Once you've created a Voice, you can save it as a User Voice for future recall. This section covers the editing of Voices other than Organ Flutes Voices, since the method of editing is different between them. For instructions on editing Organ Flutes Voices, refer to [page 46](#).

- 1 Select the desired Voice (other than an Organ Flutes Voice).
- 2 On the Voice Edit display called up via [Menu] → [VoiceEdit], select the desired parameter then edit the value.

For information about the editable parameters, refer to [page 43](#).

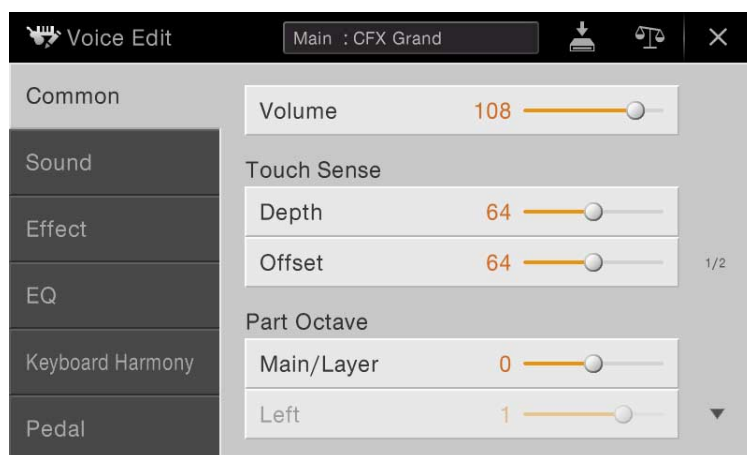

By touching (Compare) repeatedly, you can compare the sound of the edited Voice with the original (unedited) Voice.

- 3 Touch (Save) to save the edited Voice.

NOTICE

The settings will be lost if you select another Voice or turn the power to the instrument off without executing the Save operation.

NOTE If you want to edit another Voice, touch the Voice name at the top of the Voice Edit display. Or, press the VOICE [MAIN/LAYER/LEFT] button to select the Keyboard part to which the desired Voice is assigned, confirm the Voice name at the top of the Voice Edit display, make the edits as desired, then execute the Save operation.

Editable Parameters in the Voice Edit display

Common

Volume		Adjusts the volume of the current edited Voice.
Touch Sense	Depth	<p>Adjusts the touch sensitivity (velocity sensitivity), or how greatly the volume responds to your playing strength.</p> <p>Touch Sensitivity Depth Changes the velocity curve according to Velocity Depth (with Offset set to 64)</p> <p>Actual Velocity for tone generator</p> <p>• Depth: Determines the velocity sensitivity, or how much the level of the Voice changes in response to your playing strength (velocity).</p> <p>• Offset: Determines the amount by which received velocities are adjusted for the actual velocity effect.</p>
	Offset	
Part Octave	Main/Layer	Shifts the octave range of the edited Voice up or down in octaves. When the edited Voice is used as any of the Main and Layer parts, the Main/Layer parameter is available; when the edited Voice is used as the Left part, the Left parameter is available.
	Left	
Mono	Mono/Poly	Determines whether the edited Voice is played monophonically or polyphonically.
	Portamento Time	<p>Sets the portamento time (pitch transition time) when the edited Voice is set to “Mono” above.</p> <p>NOTE The Portamento Time determines the pitch transition time. Portamento is a function that creates a smooth transition in pitch from the first note played on the keyboard to the next.</p>

Sound

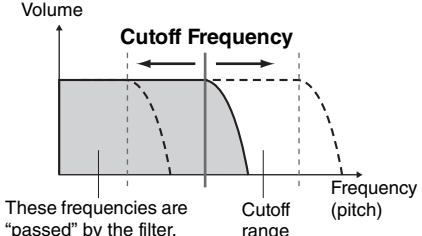
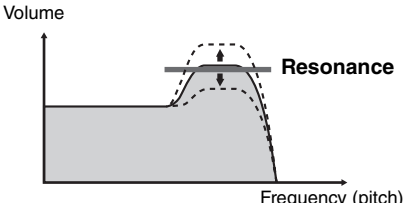
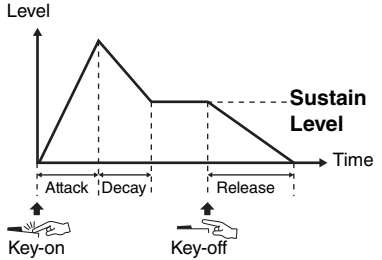
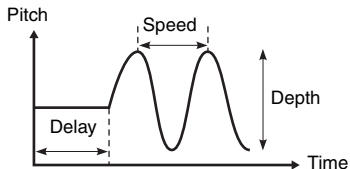
<p>Filter</p>	<p>Filter is a processor that changes the timbre or tone of a sound by either blocking or passing a specific frequency range. The parameters below determine the overall timbre of the sound by boosting or cutting a certain frequency range. In addition to making the sound either brighter or mellower, Filter can be used to produce electronic, synthesizer-like effects.</p>	
	<p>Brightness</p>	<p>Determines the cutoff frequency or effective frequency range of the filter (see diagram). Higher values result in a brighter sound.</p>  <p>The diagram shows a graph of Volume vs. Frequency (pitch). A solid line represents the filter's response, which is flat at a certain volume level and then drops off. A dashed line shows a higher cutoff frequency. A horizontal double-headed arrow labeled 'Cutoff Frequency' spans the range of frequencies that are passed. Below the graph, text says 'These frequencies are "passed" by the filter.' and 'Cutoff range'.</p>
	<p>Harmonic Cont. (Harmonic Content)</p>	<p>Determines the emphasis given to the cutoff frequency (resonance), set in Brightness above (see diagram). Higher values result in a more pronounced effect.</p>  <p>The diagram shows a graph of Volume vs. Frequency (pitch). A solid line shows a peak at the cutoff frequency. A dashed line shows a higher peak at the same frequency, labeled 'Resonance'.</p>
<p>EG</p>	<p>The EG (Envelope Generator) settings determine how the level of the sound changes in time. This lets you reproduce many sound characteristics of natural acoustic instruments — such as the quick attack and decay of percussion sounds, or the long release of a sustained piano tone.</p>  <p>The diagram shows a graph of Level vs. Time. It illustrates the attack, decay, sustain, and release phases. 'Key-on' is marked at the start of the attack phase, and 'Key-off' is marked at the start of the release phase. The 'Sustain Level' is indicated by a horizontal dashed line during the sustain phase.</p>	
	<p>Attack</p>	<p>Determines how quickly the sound reaches its maximum level after the key is played. The lower the value, the quicker the attack.</p>
	<p>Decay</p>	<p>Determines how quickly the sound reaches its sustain level (a slightly lower level than maximum). The lower the value, the quicker the decay.</p>
	<p>Release</p>	<p>Determines how quickly the sound decays to silence after the key is released. The lower the value, the quicker the decay.</p>
<p>Vibrato</p>	<p>Vibrato is a quavering, vibrating sound effect that is produced by regularly modulating the pitch of the Voice.</p>  <p>The diagram shows a graph of Pitch vs. Time. It illustrates the delay, speed, and depth of the vibrato effect. 'Delay' is the time before the vibrato starts, 'Speed' is the rate of oscillation, and 'Depth' is the range of pitch modulation.</p>	
	<p>Depth</p>	<p>Determines the intensity of the Vibrato effect. Higher settings result in a more pronounced Vibrato.</p>
	<p>Speed</p>	<p>Determines the speed of the Vibrato effect.</p>
	<p>Delay</p>	<p>Determines the amount of time that elapses between the playing of a key and the start of the Vibrato effect. Higher settings increase the delay of the Vibrato onset.</p>
<p>Modulation</p>	<p>When the Modulation function is assigned to a pedal (page 39), the pedal can be used to modulate the parameters below as well as the pitch (vibrato). Here, you can set the degree to which the pedal modulates each of the following parameters.</p>	
	<p>Filter</p>	<p>Determines the degree to which the pedal modulates the Filter Cutoff Frequency. For details about the filter, refer to page 44.</p>

Modulation	Amplitude	Determines the degree to which the pedal modulates the amplitude (volume).
	LFO Pitch	Determines the degree to which the pedal modulates the pitch, or the vibrato effect.
	LFO Filter	Determines the degree to which the pedal modulates the Filter cutoff frequency, or the wah effect.
	LFO Amplitude	Determines the degree to which the pedal modulates the amplitude, or the tremolo effect.

Effect

Insertion Effect	On/Off	Turns the Insertion Effects on or off.
	Type	Selects the Insertion Effect Type. Select the Category then select the Type. You can adjust the detailed parameters by touching  (Setting) and save them. Refer to “Editing and Saving the Effect settings” (page 13) for details.
	Depth	Adjusts the Insertion Effect Depth.
	Variation	Each Insertion Effect Type features the Variation which is turned off by default. You can use this Variation and adjust the depth of some of its parameters by turning it on. Refer to “Editing and Saving the Effect settings” (page 13) for details. NOTE Parameters that are grayed out cannot be edited.
	Vibe Rotor	Available only if “VibeRotor” in the “Legacy” category is selected as the Insertion Effect Type explained above. Determines whether Vibe Rotor should be set to on or off when selecting the Voice.
Reverb*	Depth	Adjusts the Reverb Depth.
Chorus*	Depth	Adjusts the Chorus Depth.

*Reverb and Chorus depth cannot be edited when a VRM Voice is selected, but can be edited via [Menu] → [VoiceSetting] → [Piano] (page 1/2). For details, refer to the Owner’s Manual “Playing Realistic Resonance-enhanced Piano Sounds (VRM Voices).”

EQ

Determines the Frequency and Gain of the EQ bands. For information about EQ, refer to [page 11](#).

Keyboard Harmony

From this display, you can set the same parameters as those in the Keyboard Harmony display (step 2 on [page 23](#)). Before making any settings, make sure that the current part is set to Main; in other words, you should select the Main part by touching the Voice name at the top of the Voice Edit display, or by pressing the VOICE [MAIN/LAYER/LEFT] button. The settings here are called up automatically simply by selecting the corresponding Voice.

Pedal

This section allows you to select the function to be assigned to the center or left pedal. Before making any settings, make sure that the current part is set to Main; in other words, you should select the Main part by touching the Voice name at the top of the Voice Edit display, or by pressing the VOICE [MAIN/LAYER/LEFT] button. The settings here are called up automatically simply by selecting the corresponding Voice. For details about the pedal function, refer to [page 39](#).



Editing an Organ Flutes Voice (Voice Edit)

The Organ Flute Voices can be edited by adjusting the footage levers, adding the attack sound, applying effect and equalizer, etc.

1 Select the desired Organ Flutes Voice.

From the [Organ] Category, touch [Organ Flutes], then select the desired Organ Flutes Voice.

2 On the Voice Edit display called up via [Menu] → [VoiceEdit], select the desired parameter then edit the value.

NOTE The Voice Edit display for the Organ Flutes Voices can also be called up by touching the Organ Flutes icon at upper right of the Organ Flutes Voice name in the Home display. This is useful for adjusting footage settings and controlling the rotary speaker while you play.



❶	Footage	Determines the basic sound of the organ flutes.
❷	Organ Type	Specifies the type of organ tone generation to be simulated. <ul style="list-style-type: none"> • Sine: Produces a clean, clear sound. • Vintage: Produces a gritty, slightly distorted sound. • Euro: Produces the sound of the transistor electronic organ equipped with the electronic tremolo.
❸	Volume	Adjusts the overall volume of the Organ Flutes.
❹	Rotary Speaker	Turns on or off the Rotary Speaker and switches the Rotary Speaker speed between the “Slow” and “Fast.” This parameter is available only when an effect which contains “Rotary” or “Rot” in its name is applied.
❺	Vibrato	Turns on or off the vibrato, and adjusts its depth and speed.
❻	Response	Affects both the attack and release (page 44) portion of the sound, increasing or decreasing the response time of the initial swell and release, based on the Footage controls. The higher the value, the slower the swell and release.
❼	Attack	Selects “First” or “Each” as the Attack mode and adjusts the Attack length of the sound. In the First mode, attack (percussive sound) is applied only to the first notes played and held simultaneously; while the first notes are held, any subsequently played notes have no attack applied. In the Each mode, attack is applied equally to all notes. The Attack length produces a longer or shorter decay immediately after the initial attack. The longer the value, the longer the decay time.

- 3** As necessary, touch  (Setting) then set the parameters related to the Effects and EQ.
The parameters are same as those in the Effect display and EQ display of the previous chapter “Editing a Voice (Voice Edit)” (page 45).

- 4** Touch  (Save) to save the created Organ Flutes Voice.

NOTICE

The settings will be lost if you select another Voice or turn the power to the instrument off without executing the Save operation.

NOTE If you want to edit another Voice, touch the Voice name at the top of the Voice Edit display. Or, press the VOICE [MAIN/LAYER/LEFT] button to select the Keyboard part to which the desired Voice is assigned, confirm the Voice name at the top of the Voice Edit display, make the edits as desired, then execute the Save operation.



Creating/Editing Styles (Style Creator)

The Style Creator function lets you create an original Style by recording the rhythm pattern via the keyboard performance and using the already-recorded Style data. Basically, select a preset Style that is closest to the type you want to create, then record the rhythm pattern, bass line, chord backing, or phrase (referred to as “Source Pattern” in the Style Creator) for each channel of each Section. Like the Song, two Recording methods are available: Realtime Recording and Step Recording ([page 49](#)).

■ Style Data Structure – Consisting of Source Patterns

A Style is made up of different Sections (Intro, Main, Ending, etc.) and each Section has eight separate channels, each of which is referred to as a “Source Pattern.” With the Style Creator feature, you can create a Style by separately recording the Source Pattern for each channel, or by importing pattern data from other existing Styles.

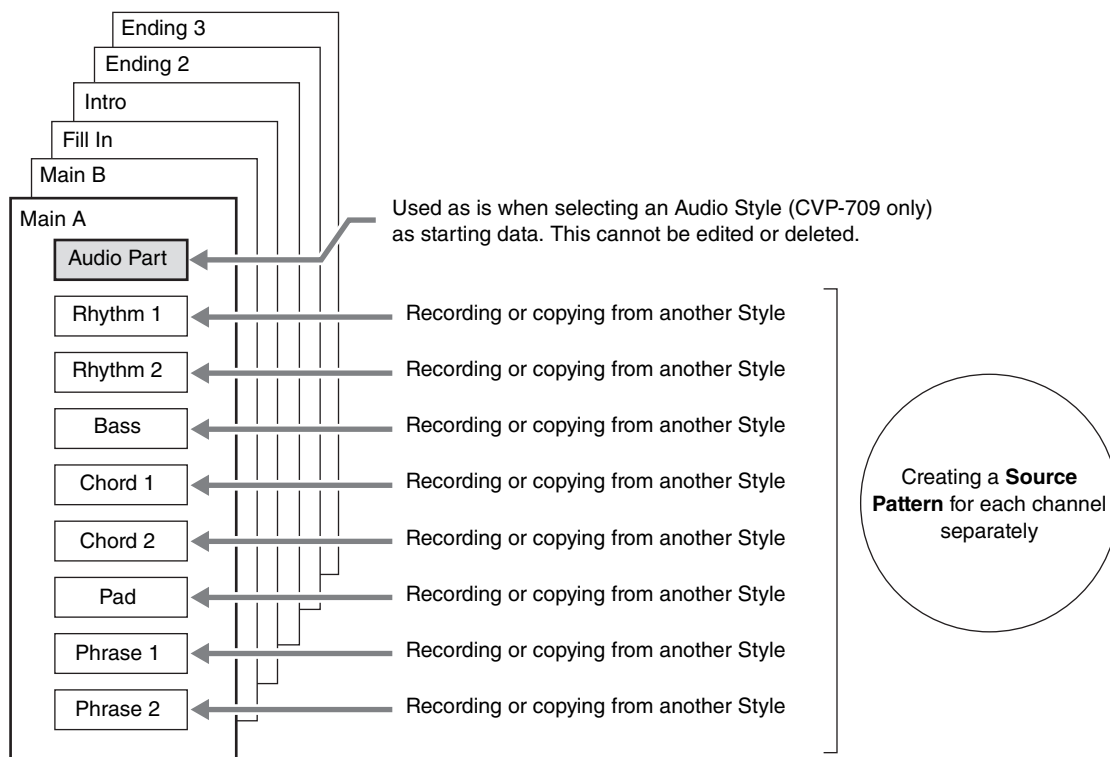

Limitations on the Audio part (CVP-709 only):

- If you select a preset Audio Style as starting data, the Audio part will be used as is. The Audio part cannot be deleted, edited or created from scratch.
- The created Style containing the Audio part can be used only via an instrument that supports Audio Styles as well as the SFF GE format.
- The Audio part cannot be copied from another Style or Section in the “Assembly” display ([page 54](#)). If you want to use a specific Audio part, make sure to select the corresponding Audio Style before calling up the Style Creator display.

■ Basic Procedure for creating a Style

The detailed instructions are described on the reference page of each step.

1 Select the desired Style as starting data.

2 Call up the Style Creator display via [Menu] → [StyleCreator].

3 On the “Basic” display, select a Section (page 50).

As necessary, make the following settings.

- If you create a Style entirely from scratch, touch [Initialize Style] to make the current Style empty.
- If you initialize the Style, set the length (measure amount) of the Source Pattern.
- Set the overall parameters such as Tempo and Beat.

4 Create the Source Pattern for each channel.

• Realtime Recording (page 51)

Lets you record the Style by simply playing the keyboard.

• Step Recording (page 54)

Lets you enter each note individually.

• Style Assembly (page 54)

Lets you copy various patterns from other preset Styles or Styles you have already created.

5 Edit the already recorded channel data.

• Channel Edit (page 55)

Lets you edit the MIDI data of the already recorded channels.

• SFF Edit (page 57)

Lets you edit the SFF (Style File Format) related parameters of the already recorded channels other than Rhythm channels.

6 Repeat steps 3 – 5 as desired.

7 Touch (Save) at the top of the display to save the created Style.

Basic

The explanations here apply to step 3 on [page 49](#). This display lets you set the basic parameters such as Section selection.

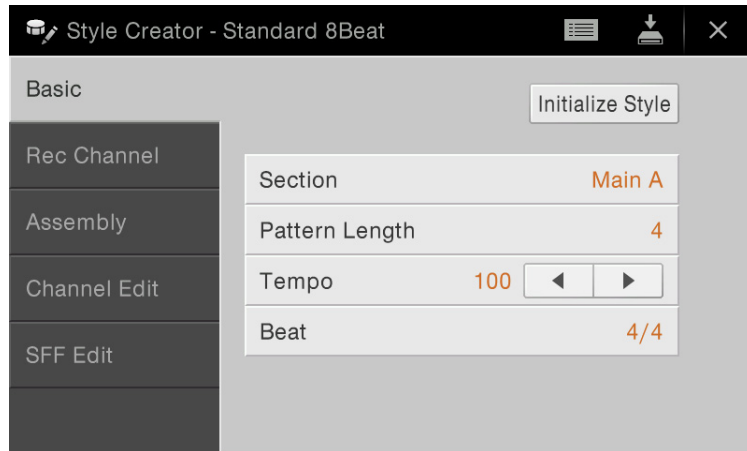

Initialize Style	Initializes all channel data of all Sections belonging to make the current Style empty. Touch here when you want to create the Style data from scratch.
Section	Selects a Section for creating or editing.
Pattern Length	Selects the length (in measures) of the current Section. After inputting the value, touch [Execute] to actually enter the changes. NOTE If an Audio Style (CVP-709 only) is selected as starting data, changing the pattern length deletes the corresponding Audio part.
Tempo	Sets the tempo of the Style. The setting here commonly applies to all Sections.
Beat	Sets the beat of the Style. The setting here commonly applies to all Sections. After inputting the value, touch [Execute] to actually enter the changes.

Realtime Recording

The explanations here apply to step 4 on [page 49](#). In the “Rec Channel” display, you can create the channel data via the Realtime Recording.

Realtime Recording Characteristics in the Style Creator

■ Loop Recording

Style playback repeats the rhythm patterns of several measures in a “loop,” and Style recording is also done using loops. For example, if you start recording with a two-measure Main section, the two measures are repeatedly recorded. Notes that you record will play back from the next repetition (loop), letting you record while hearing previously recorded material.

■ Overdub Recording

This method records new material to a channel already containing recorded data, without deleting the original data. In Style recording, the recorded data is not deleted, except when using functions such as “Clear Drum Inst” ([page 52](#)) “Delete” ([pages 52, 53](#)) and “Remove Event” ([page 56](#)). For example, if you start recording with a two-measure Main section, the two measures are repeated many times. Notes that you record will play back from the next repetition, letting you overdub new material to the loop while hearing previously recorded material. When creating a Style based on an existing internal Style, overdub recording is applied only to the rhythm channels. For all other channels (except rhythm), you need to delete the original data before recording.

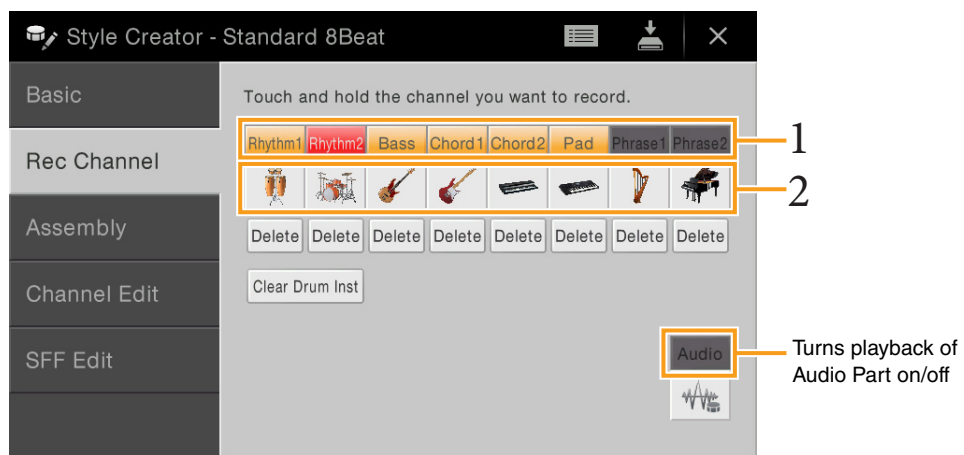

■ Recording Rhythm Channels 1 – 2

If you select an Audio Style (CVP-709 only) as starting data:

Playback of the Audio part can be turned on or off, but it cannot be edited or deleted. Note that the rhythm pattern of this part will be used in the new Style you intend to create. If you want to create a rhythm phrase in addition to the Audio part, follow the steps below.

1 On the “Rec Channel” display, touch and hold the desired channel until it turns red.

The selected channel becomes the Recording target whether the channel already contains data or not. If recorded data is already included, you should record the additional notes to the selected channel as Overdub Recording.



2 If necessary, select a Voice then practice the rhythm pattern to be recorded.

Touch the instrument icon (illustration) to call up the Voice Selection display then select the desired Voice such as Drum Kit. After selecting, touch [Close] to return to the original display. With the selected Voice, practice the rhythm pattern to be recorded.

Available Voices for recording

For the Rhythm1 channel, any except Organ Flutes Voices can be used for recording.
 For the Rhythm2 channel, only Drum/SFX kits can be used for recording.

3 Press the STYLE CONTROL [▶/■](START/STOP) button to start recording.

Since already recorded data plays back, turn each channel on or off by touching as desired.
 If necessary, delete a channel by touching [Delete] located under the desired channel.

4 As soon as loop playback returns to the first beat in the first measure, start playing the rhythm pattern to be recorded.

If the rhythm is difficult to play all at once, you can break it down into isolated parts, such as in this example:

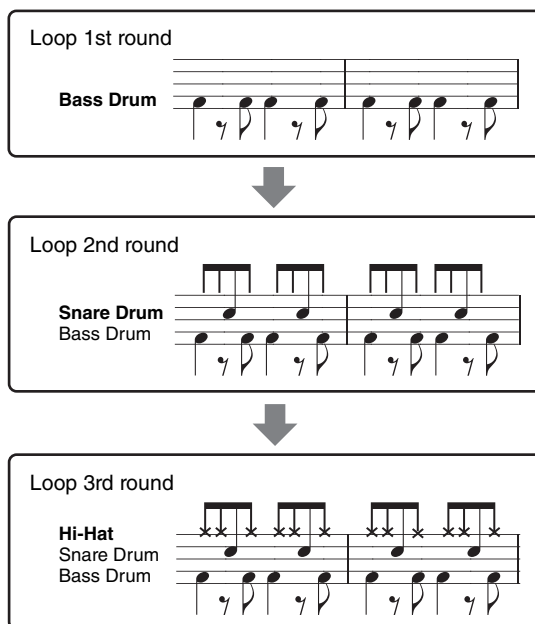

If you make a mistake or play any wrong notes:

You can delete notes of a specific drum instrument. Touch [Clear Drum Inst] to call up a message, then press the corresponding key on the keyboard while the message is shown. After deleting the desired drum instrument, touch [Exit] to close the message.

5 Press the STYLE CONTROL [▶/■](START/STOP) button to stop playback.

If you want to add more notes, press the [▶/■] (START/STOP) button again to continue recording.

6 Touch and hold the Recording channel for a while (until the button changes color) to exit from the Recording mode.

■ Recording Bass, Chord 1 – 2, Pad and Phrase 1 – 2

1 On the “Rec Channel” display, touch and hold the desired channel until it turns red.

If the selected channel already contains data, a confirmation message appears, prompting you whether or not to delete the existing data of the selected channel. Touch [Yes] to delete data and the selected channel is specified as Record target. Note that channel data other than the Rhythm channels of the preset Style cannot be overdubbed.



2 If necessary, select a Voice then practice the bass line, chord backing, or phrase to be recorded.

Touch the instrument icon (illustration) to call up the Voice Selection display then select the desired Voice. After selecting, touch [Close] to return to the original display. With the selected Voice, practice the phrase or chord backing to be recorded.

Available Voices for recording

Any except for the Organ Flutes/Drum kit/SFX kit Voices can be used for recording.

■ Record a phrase in CM7 which will play appropriate notes as change chords during performance

Rules when recording a Main or Fill-in

With the default initial settings, the Source Root/Chord is set to CM7. This means that you should record a Source Pattern which is to be triggered by specifying CM7 during normal performance. Record a bass line, phrase or chord backing which you want to hear when CM7 is specified. Specifically, see the rules below.

- Use only the CM7 scale tones when recording the Bass and Phrase channels (i.e., C, D, E, G, A, and B).
- Use only the chord tones when recording the Chord and Pad channels (i.e., C, E, G, and B).



C = Chord note
C, R = Recommended note

If you observe these rules, Style playback notes are appropriately converted depending on the chord changes you make during your performance.

Rules when recording an Intro or Ending

These Sections are designed assuming that the chord is not changed during playback. This is why you need not observe the rules for Main and Fill-In Sections described above, and you can make the chord progression in recording. However, follow the rules below since the Source Root/Chord is set to CM7 by default.

- When recording the Intro, make sure that the recorded phrase leads properly into a C scale.
- When recording the Ending, make sure that the recorded phrase begins with or properly follows a C scale.

■ Setting the Source Root/Chord if necessary

Although the default Source Root/Chord is set to CM7 as described above, you can change this to any desired one in which you can play easily. Call up the “SFF Edit” display, set the Source Root and Chord to the favorite or desired Root and Chord type. Keep in mind that when you change the Source Chord from the default CM7 to another chord, the chord notes and recommended notes will also change. For details, refer to [page 58](#).

3 Press the STYLE CONTROL [▶/■](START/STOP) button to start recording.

With the already recorded data playing back, turn each channel on or off by touching as desired. If necessary, delete a channel by touching [Delete] located under the desired channel.

4 As soon as loop playback returns to the first beat in the first measure, start playing the bass line, chord backing or phrase to be recorded.

5 Press the [▶/■](START/STOP) button to stop playback.

If you want to add more notes, press the [▶/■](START/STOP) button again to continue recording.

■ To hear the playback sound of the already recorded channels with another Source Chord/Root:

- 1) Call up the “SFF Edit” display, then set the “Target Ch” at the top of the display to “Rhythm1” or “Rhythm2.”
- 2) Touch [Play Root/Chord] to call up the operation display.
- 3) Press the STYLE CONTROL [▶/■](START/STOP) button to start playback.
- 4) On the display, set the “Play Root/Chord” to the desired Chord root and Chord type.
This operation lets you hear how the Source Pattern is played back via chord changes during normal performance.

6 Touch and hold the Recording channel for a while (until the button changes color) to exit from the Recording mode.

Step Recording

The explanations here apply to step 4 on [page 49](#). In the Step Recording (Style Edit) display called up by touching  (Edit) at the upper right of the display, you can record or edit notes one by one. This Step Recording procedure is essentially the same as that for Song Recording ([page 62](#)) with the exception of the points listed below:

- In the Song Creator, the “End” mark position can be changed freely; in the Style Creator, it cannot be changed. This is because the length of the Style is fixed for all channels as you set in the “Basic” display ([page 50](#)). For example, if you create a Style of four measures length, the “End” mark position is automatically set to the end of fourth measure, and cannot be changed in the Style Edit display.
- Recording channels can be changed in the Song Creator’s Edit display; however, they cannot be changed in the Style Creator. Select the Recording channel in the “Rec channel” display.
- In the Style Creator, Chord, Lyrics, and System Exclusive data cannot be entered. The Channel data can be entered and System Exclusive data can be edited (delete, copy or move).

NOTE If you select a preset Audio Style (CVP-709 only) as starting data, the Audio part will be used as is. The Audio part cannot be deleted, edited or created from scratch.

Assembly — Assigning the Source Pattern to Each Channel

The explanations here apply to step 4 on [page 49](#). The “Assembly” display shows that each channel data of the current Section has been copied from which Style, which Section, and which channel. For each channel, touch the Style name, Section name, or Channel name as necessary to select the desired one.

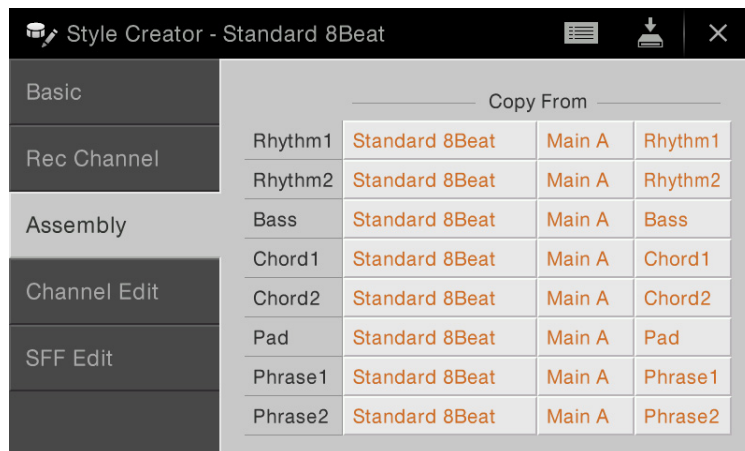

	Copy From		
Rhythm1	Standard 8Beat	Main A	Rhythm1
Rhythm2	Standard 8Beat	Main A	Rhythm2
Bass	Standard 8Beat	Main A	Bass
Chord1	Standard 8Beat	Main A	Chord1
Chord2	Standard 8Beat	Main A	Chord2
Pad	Standard 8Beat	Main A	Pad
Phrase1	Standard 8Beat	Main A	Phrase1
Phrase2	Standard 8Beat	Main A	Phrase2

NOTE An Audio part (CVP-709 only) cannot be copied from another Style. If you want to use a specific Audio part, make sure to select the corresponding Audio Style before calling up the Style Creator display.

NOTE If you select an Audio Style as starting data, the Audio part cannot be replaced with different data.

Channel Edit

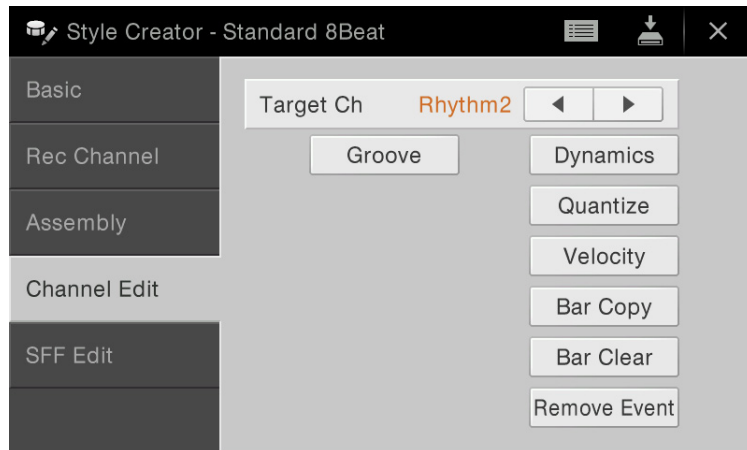

The explanations here apply to step 5 on [page 49](#). The “Channel Edit” display lets you edit the already recorded channel data. Select the Target channel then edit the desired parameters.

After editing the desired parameter, touch [Execute] to actually enter the edits for each setup window. When execution is completed, this button changes to [Undo], letting you restore the original data if you are not satisfied with the results. The Undo function only has one level; only the previous operation can be undone.



NOTE If you select a preset Audio Style (CVP-709 only) as starting data, the Audio part will be used as is. The Audio part cannot be deleted, edited or created from scratch.

Target Ch	Select the target channel to be edited. All items with the exception of the “Groove” are to be applied to the channel specified here.
Groove	This lets you add swing to the music or change the “feel” of the beat by making subtle shifts in the timing (clock) of the Style. The Groove settings are applied to all channels of the selected Section.
	Original Beat Specifies the beats to which Groove timing is to be applied. In other words, if “8 Beat” is selected, Groove timing is applied to the 8th notes; if “12 Beat” is selected, Groove timing is applied to 8th-note triplets.
	Beat Converter Actually changes the timing of the beats (specified in the “Original Beat” parameter above) to the selected value. For example, when Original Beat is set to “8 Beat” and Beat Converter is set to “12,” all 8th notes in the section are shifted to 8th-note triplet timing. The “16A” and “16B” Beat Converter which appear when Original Beat is set to “12 Beat” are variations on a basic 16th-note setting.
	Swing Produces a “swing” feel by shifting the timing of the back beats, depending on the “Original Beat” parameter above. For example, if the specified Original Beat value is “8 Beat”, the Swing parameter will selectively delay the 2nd, 4th, 6th, and 8th beats of each measure to create a swing feel. The settings “A” through “E” produce different degrees of swing, with “A” being the most subtle and “E” being the most pronounced.
	Fine Selects a variety of Groove “templates” to be applied to the selected section. The “Push” settings cause certain beats to be played early, while “Heavy” settings delay the timing of certain beats. The numbered settings (2, 3, 4, 5) determine which beats are to be affected. All beats up to the specified beat — but not including the first beat — will be played early or delayed (for example, the 2nd and 3rd beats, if “3” is selected). In all cases, “A” types produce minimum effect, “B” types produce medium effect, and “C” types produce maximum effect.

Dynamics	This changes the velocity/volume (or accent) of certain notes in the Style playback. The Dynamics settings can be applied to each channel individually or all channels of the selected Style.	
	Accent Type	Determines the type of accent applied — in other words, which notes are emphasized.
	Strength	Determines how strongly the selected Accent Type (above) will be applied. The higher the value, the stronger the effect.
	Expand/Compress	Expands or compresses the range of velocity values. Values higher than 100% expand the dynamic range, while values lower than 100% compress it.
	Boost/Cut	Boosts or cuts all velocity values. Values above 100% boost the overall velocity, while values below 100% reduce it.
	Apply To All Channels	When set to “On,” the settings in this display will be applied to all the channels of the current Section. When set to “Off,” the settings in this display will be applied to the channel specified at the “Target Ch” in the Channel Edit display.
Quantize	Same as in the Song Creator (page 71), with the exception of the two additional available parameters below.  Eighth notes with swing  Sixteenth notes with swing	
Velocity	Boosts or cuts the velocity of all notes in the specified channel, according to the percentage specified here.	
Bar Copy	This function allows data to be copied from one measure or group of measures to another location within the specified channel.	
	Source Top	Specifies the first (Source Top) and last (Source Last) measures in the region to be copied.
	Source Last	
	Destination	Specifies the first measure of the destination location, to which the data is to be copied.
Bar Clear	This function clears all data from the specified range of measures within the selected channel.	
Remove Event	This function lets you remove specific events from the selected channel.	

SFF Edit — Making Style File Format Settings

The explanations here apply to step 5 on [page 49](#). The Style File Format (SFF) combines all of Yamaha’s Style playback know-how into a single unified format. Setting the SFF related parameters determines how the original notes are converted to the actual sounded notes based on the chord you specify in the Chord area of the keyboard. The conversion flow is shown below.

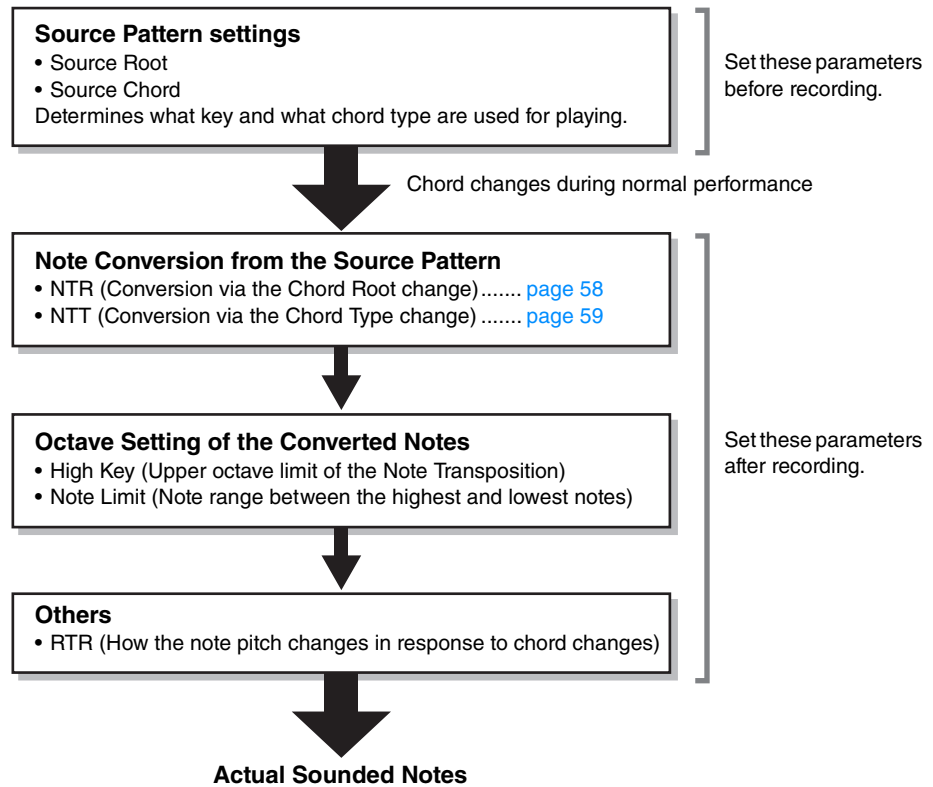

The parameters shown above can be set in the “SFF Edit” display.

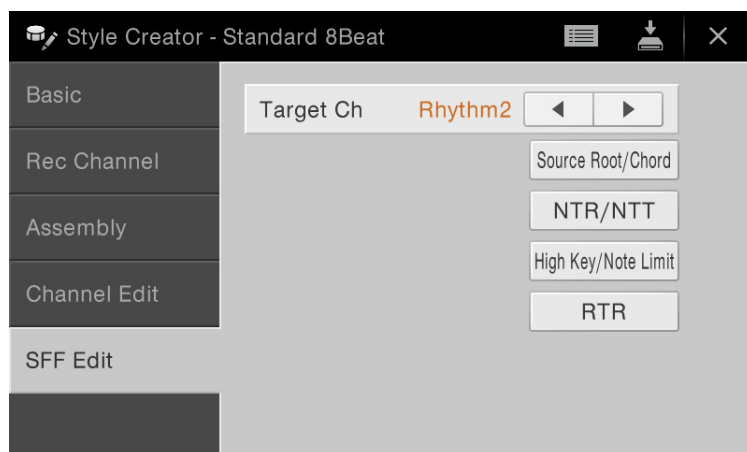

NOTE If you select a preset Audio Style (CVP-709 only) as starting data, the Audio part will be used as is. The Audio part cannot be deleted, edited or created from scratch.

<p>Target Ch</p> <p>Select the target channel to be edited.</p>	<p>Select the target channel to be edited.</p>								
<p>Source Root/Chord (Play Root/Chord)</p>	<p>These settings determine the original key of the Source Pattern (i.e., the key used when recording the pattern to the channel other than the Rhythm channels). If you set “Fm7” here, specifying “Fm7” in the Chord section of the keyboard will play back the originally recorded data (Source Pattern). The default setting is “CM7” (Source Root = C and Source Chord = M7). Depending on the selected chord type specified here, the playable notes (scale notes and chord notes) differ. When “Initialize Style” is executed in the “Basic” display, the default setting of CM7 is automatically selected.</p> <p>Playable notes when Source Root is C:</p> <p>C = Chord notes C, R = Recommended notes</p> <p>IMPORTANT Make sure to set the parameters here before recording. If you change the settings after recording, the recorded Source Pattern cannot be converted to the appropriate notes when changing the chord during your keyboard performance.</p> <p>NOTE When the parameters for the selected Target Ch are set to NTR: Root Fixed, NTT Type: Bypass, or NTT Bass: Off, the parameters here are changed to “Play Root” and “Play Chord,” respectively. In this case, you can change chords and hear the resulting sound for all channels.</p> <p>NOTE The settings here are not applied when NTR is set to “Guitar.”</p>								
<p>NTR/NTT (Note Transposition Rule/Note Transposition Table)</p>	<p>The parameters here determine how the notes in the Source Pattern are converted according to the chord changes during your keyboard performance.</p> <table border="1"> <tr> <td data-bbox="363 1332 646 2049"> <p>NTR</p> </td> <td data-bbox="646 1332 1444 2049"> <p>Selects the Note Transposition Rule which determines how the notes in the Source Pattern are transposed according to the Chord Root change.</p> </td> </tr> <tr> <td data-bbox="363 1422 646 1680"> <p>Root Trans</p> </td> <td data-bbox="646 1422 1444 1680"> <p>When the root note is transposed, the interval between notes is maintained. For example, the notes C3, E3 and G3 in the key of C become F3, A3 and C4 when they are transposed to F. Use this setting for channels that contain melody lines.</p> <p>When playing a C major chord. → When playing an F major chord.</p> </td> </tr> <tr> <td data-bbox="363 1680 646 1937"> <p>Root Fixed</p> </td> <td data-bbox="646 1680 1444 1937"> <p>The note is kept as close as possible to the previous note range. For example, the notes C3, E3 and G3 in the key of C become C3, F3 and A3 when they are transposed to F. Use this setting for channels that contain chord parts.</p> <p>When playing a C major chord. → When playing an F major chord.</p> </td> </tr> <tr> <td data-bbox="363 1937 646 2049"> <p>Guitar</p> </td> <td data-bbox="646 1937 1444 2049"> <p>This is exclusively for transposing guitar accompaniment. Notes are transposed to approximate the chords played with natural guitar fingering.</p> </td> </tr> </table>	<p>NTR</p>	<p>Selects the Note Transposition Rule which determines how the notes in the Source Pattern are transposed according to the Chord Root change.</p>	<p>Root Trans</p>	<p>When the root note is transposed, the interval between notes is maintained. For example, the notes C3, E3 and G3 in the key of C become F3, A3 and C4 when they are transposed to F. Use this setting for channels that contain melody lines.</p> <p>When playing a C major chord. → When playing an F major chord.</p>	<p>Root Fixed</p>	<p>The note is kept as close as possible to the previous note range. For example, the notes C3, E3 and G3 in the key of C become C3, F3 and A3 when they are transposed to F. Use this setting for channels that contain chord parts.</p> <p>When playing a C major chord. → When playing an F major chord.</p>	<p>Guitar</p>	<p>This is exclusively for transposing guitar accompaniment. Notes are transposed to approximate the chords played with natural guitar fingering.</p>
<p>NTR</p>	<p>Selects the Note Transposition Rule which determines how the notes in the Source Pattern are transposed according to the Chord Root change.</p>								
<p>Root Trans</p>	<p>When the root note is transposed, the interval between notes is maintained. For example, the notes C3, E3 and G3 in the key of C become F3, A3 and C4 when they are transposed to F. Use this setting for channels that contain melody lines.</p> <p>When playing a C major chord. → When playing an F major chord.</p>								
<p>Root Fixed</p>	<p>The note is kept as close as possible to the previous note range. For example, the notes C3, E3 and G3 in the key of C become C3, F3 and A3 when they are transposed to F. Use this setting for channels that contain chord parts.</p> <p>When playing a C major chord. → When playing an F major chord.</p>								
<p>Guitar</p>	<p>This is exclusively for transposing guitar accompaniment. Notes are transposed to approximate the chords played with natural guitar fingering.</p>								

NTR/NTT (Note Transposition Rule/Note Transposition Table)	NTT Type	Selects the Note Transposition Table which determines how the notes in the Source Pattern are transposed according to the Chord Type change.	
		When NTR is set to “Root Trans” or “Root Fixed”:	
		Bypass	When NTR is set to Root Fixed, the transposition table used does not do any note conversion. When NTR is set to Root Trans, the table used only converts the notes by maintaining the pitch relationship between notes.
		Melody	Suitable for melody line transposition. Use this for melody channels such as “Phrase1” and “Phrase2.”
		Chord	Suitable for chordal parts transposition. Use this for the “Chord1” and “Chord2” channels, especially when they contain piano or guitar-like chordal parts.
		Melodic Minor	When the played chord changes from a major to a minor chord, this table lowers the third interval in the scale by a semitone. When the chord changes from a minor to a major chord, the minor third interval is raised by a semitone. Other notes are not changed. Use this for melody channels of Sections which respond only to major/minor chords, such as Intros and Endings.
		Melodic Minor 5th	In addition to the Melodic Minor transposition above, augmented and diminished chords affect the 5th note of the Source Pattern.
		Harmonic Minor	When the played chord changes from a major to a minor chord, this table lowers the third and sixth intervals in the scale by a semitone. When the chord changes from a minor to a major chord, the minor third and flatted sixth intervals are raised by a semitone. Other notes are not changed. Use this for chord channels of Sections which respond only to major/minor chords, such as Intros and Endings.
		Harmonic Minor 5th	In addition to the Harmonic Minor transposition above, augmented and diminished chords affect the 5th note of the Source pattern.
		Natural Minor	When the played chord changes from a major to a minor chord, this table lowers the third, sixth and seventh intervals in the scale by a semitone. When the chord changes from a minor to a major chord, the minor third, flatted sixth and flatted seventh intervals are raised by a semitone. Other notes are not changed. Use this for chord channels of Sections which respond only to a major/minor chord such as Intros and Endings.
		Natural Minor 5th	In addition to the Natural Minor transposition above, augmented and diminished chords affect the 5th note of the Source pattern.
		Dorian	When the played chord changes from a major to a minor chord, this table lowers the third and seventh intervals in the scale by a semitone. When the chord changes from a minor to a major chord, the minor third and flatted seventh intervals are raised by a semitone. Other notes are not changed. Use this for chord channels of Sections which respond only to a major/minor chord such as Intros and Endings.
		Dorian 5th	In addition to the Dorian transposition above, augmented and diminished chords affect the 5th note of the Source pattern.
		When NTR is set to “Guitar”:	
		All Purpose	This table covers both strummed and arpeggio-played sounds.
Stroke	Suitable for strumming sounds of the guitar. Some notes may sound as if they are muted—this is the normal condition when chords are played on guitar by strumming.		

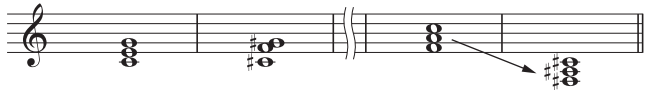
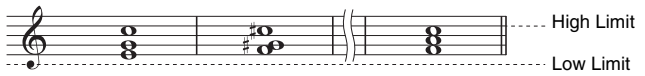
NTR/NTT (Note Transposition Rule/Note Transposition Table)	NTT Type	Arpeggio	Suitable for arpeggio-played sound of the guitar, resulting in beautiful four-note arpeggio sounds.
	NTT Bass	The channel for which this is set to “On” will be played back by the bass root note, when the on-bass chord is recognized by the instrument. When NTR is set to Guitar and this parameter is set to “On,” only the note which is assigned to bass will be played back by the bass root note.	
	NTR/NTT Settings for the Rhythm Channels Since the Rhythm channels should not be affected by Chord change, make sure to make the following settings. <ul style="list-style-type: none"> • NTR = Root Fixed • NTT = Bypass • NTT Bass = Off With the above settings, the “Source Root” and “Source Chord” parameters are changed to “Play Root” and “Play Chord,” respectively.		
High Key/Note Limit	Adjusts the Octave of the notes converted via the NTT and NTR.		
	High Key	This sets the highest key (upper octave limit) of the note transposition for the chord root change. Any notes calculated to be higher than the highest key are transposed down to the next lowest octave. This setting is available only when the NTR parameter (page 58) is set to “Root Trans.” Example — When the highest key is F Root changes → CM C#M . . . FM F#M . . . Notes played → C3-E3-G3 C#3-F3-G#3 F3-A3-C4 F#2-A#2-C#3 	
	Note Limit Low	These set the note range (highest and lowest notes) for Voices recorded to the Style channels. By judicious setting of this range, you can ensure that the Voices sound as realistic as possible — in other words, that no notes outside the natural range are sounded (e.g., high bass sounds or low piccolo sounds). Example — When the lowest note is C3 and the highest is D4 Root changes → CM C#M . . . FM . . . Notes played → E3-G3-C4 F3-G#3-C#4 F3-A3-C4 	
Note Limit High			
RTR (Retrigger Rule)	These settings determine whether notes stop sounding or not and how they change pitch in response to chord changes.		
	Stop	The notes stop sounding.	
	Pitch Shift	The pitch of the note will bend without a new attack to match the type of the new chord.	
	Pitch Shift to Root	The pitch of the note will bend without a new attack to match the root of the new chord. However, the octave of the new note remains the same.	
	Retrigger	The note is retriggered with a new attack at a new pitch corresponding to the next chord.	
	Retrigger To Root	The note is retriggered with a new attack at the root note of the next chord. However, the octave of the new note remains the same.	

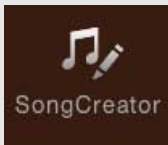

Creating/Editing MIDI Songs (Song Creator)

The Owner's Manual covers how to create an original Song by recording your keyboard performance (see instructions of Realtime Recording). This Reference Manual shows how to create an original Song by entering notes one by one (instructions of the Step Recording) and how to improve the already created Song by editing the detailed parameters.

■ Realtime Recording and Step Recording

When creating a Song, these two Recording methods are available. With Realtime Recording, this instrument records the performance data as it is played. With Step Recording, you can compose your performance by "writing" it down one event at a time. For instructions about the Realtime Recording, refer to the Owner's Manual. As the method of re-recording a specific part of a Song in realtime, you can use the Punch In/Out function (page 83).

This chapter covers mainly the instructions of Step Recording.

■ MIDI Song Data Structure

A MIDI Song consists of 16 MIDI channels. You can create data of a MIDI Song by recording your performance to a specific channel or channels in realtime, or by executing Step Recording.

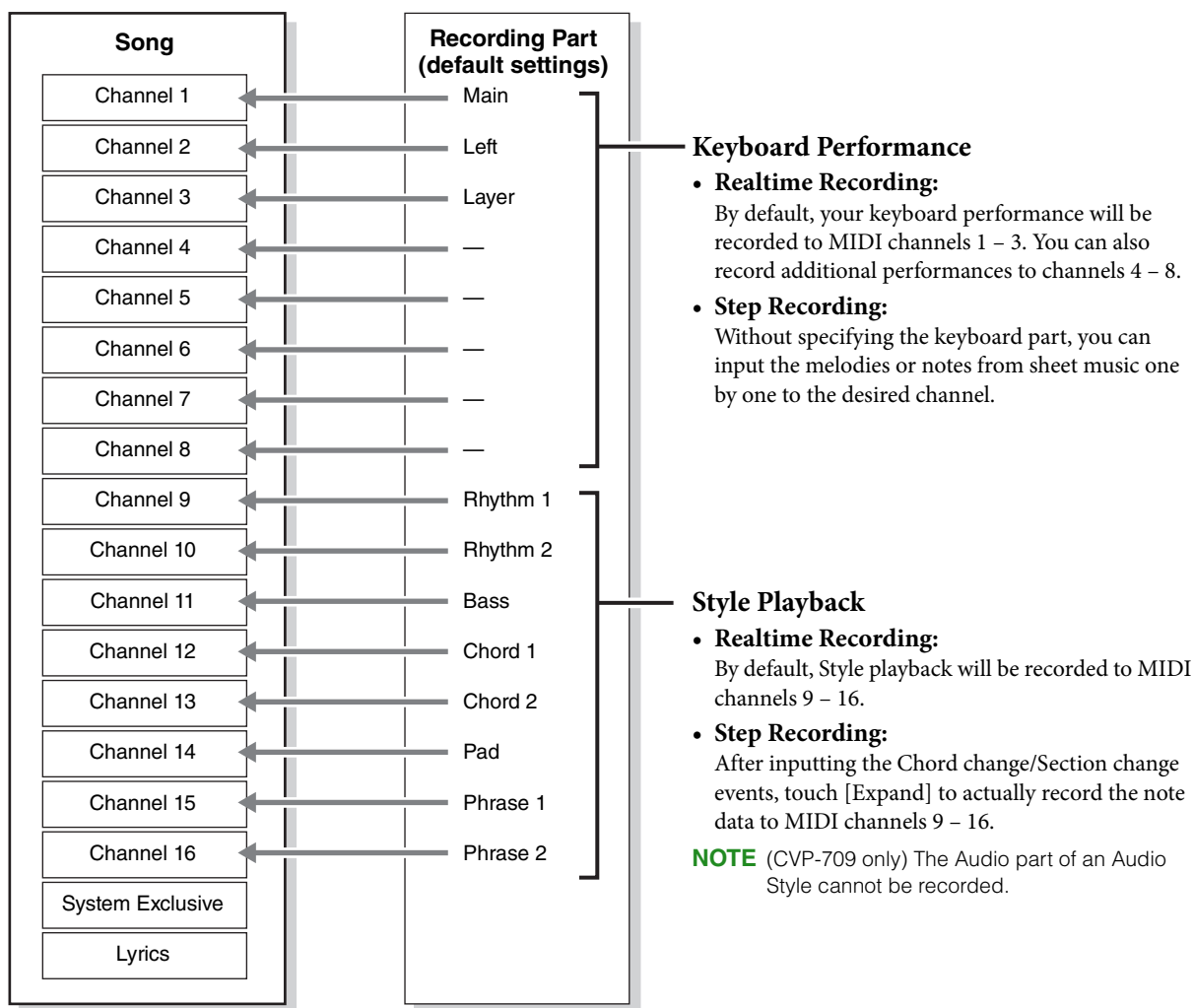



■ Basic Procedure for creating a Song

This section covers the basic procedure for Step Recording.

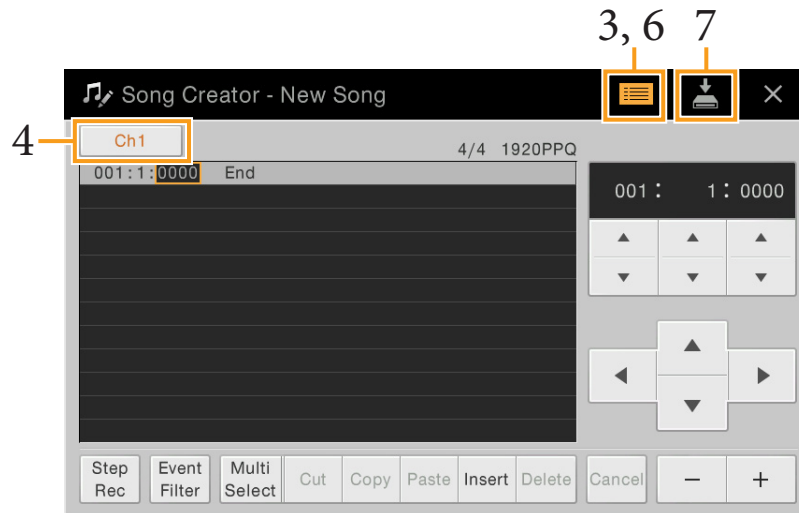
- 1 Select the desired Song or create a new empty Song.**
To create an empty Song, press the [●] (REC) button, then touch [New MIDI] and [Cancel] in order.
- 2 Call up the Song Creator display via [Menu] → [SongCreator].**
- 3 Touch  (Edit) at the top of this display to call up the Song Edit display.**



- 4 Touch [Ch1] at the top left of this display to select the Recording Target channel.**
 - If you want to record the keyboard performance, select one of “Ch1” – “Ch8.” If you do not intend to use Style playback for the Song, “Ch9” – “Ch16” can be selected.
 - If you want to edit the System Exclusive data, select “SysEx.”
 - If you want to edit Lyrics, select “Lyrics.”
 - If you want to record Style playback (Chord change and Section change events), select “Chord.”
- 5 According to selection in step 4, execute the Step Recording or data edits.**
 - **When one of “Ch1” – “Ch16” is selected:**
For instructions on editing already recorded data, refer to [page 68](#).
For instructions on inputting melodies via Step Recording, touch [Step Rec] at the bottom left of the display then refer to [page 63](#).
 - **When “SysEx” is selected:**
Edit the already recorded data, following the explanations on [page 68](#). Step Recording is not available.
 - **When “Lyrics” is selected:**
Edit the already recorded data, following the explanations on [page 68](#). Step Recording is not available.
 - **When “Chord” is selected:**
For instructions on editing already recorded data, refer to [page 68](#).
For instructions on inputting Chord/Section Change events for Style playback via Step Recording, touch [Step Rec] then refer to [page 66](#).
- 6 If necessary, touch  (Edit) to return to the portal display of the Song Creator, then execute the Channel Edit function ([page 71](#)).**
- 7 Touch  (Save) at the top right of the display to save the created Song.**

NOTICE

The recorded Song data will be lost if you select another Song or turn off the power to the instrument without executing the Save operation.

Recording Melodies via Step Recording

The explanations here apply when one of “Ch1” – “Ch16” is selected in step 5 on [page 62](#). With [Step Rec] turned on at the bottom left of the display, you can input the notes one by one, using the controls below.

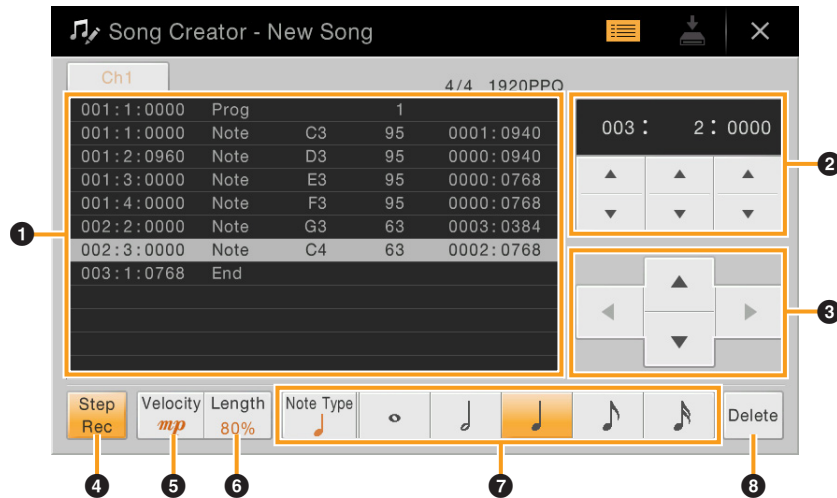

■ Control Names and Functions

1	Event List	Indicates events such as note and Voice selection which have been input. For details, refer to page 69 .								
2	Song Position (Measure: Beat: Clock)	Indicates the current Song position. Events such as note and Voice selection you have input are recorded at the position indicated here. You can change the current position by touching [▲] or [▼] below the Measure, Beat, and Clock* respectively. *Clock Smallest unit for the Song position and note length. A quarter note consists of 1920 clocks.								
3	Cursor	Lets you move the cursor position.								
4	Step Rec	Turning this on shows the Step Recording display, and turning it off shows the Song Edit display.								
5	Velocity	Determines the velocity (loudness) of the note to be entered. The velocity value can be specified within a range from 1 to 127. The higher the velocity value, the louder the sound becomes. Kbd.Vel: Actual resulting velocity <table data-bbox="555 1574 842 1720"> <tr> <td><i>fff</i> : 127</td> <td><i>mp</i> : 63</td> </tr> <tr> <td><i>ff</i> : 111</td> <td><i>p</i> : 47</td> </tr> <tr> <td><i>f</i> : 95</td> <td><i>pp</i> : 31</td> </tr> <tr> <td><i>mf</i> : 79</td> <td><i>ppp</i> : 15</td> </tr> </table>	<i>fff</i> : 127	<i>mp</i> : 63	<i>ff</i> : 111	<i>p</i> : 47	<i>f</i> : 95	<i>pp</i> : 31	<i>mf</i> : 79	<i>ppp</i> : 15
<i>fff</i> : 127	<i>mp</i> : 63									
<i>ff</i> : 111	<i>p</i> : 47									
<i>f</i> : 95	<i>pp</i> : 31									
<i>mf</i> : 79	<i>ppp</i> : 15									
6	Length	Determines the gate time (note length) of the note to be entered. <table data-bbox="507 1794 994 1944"> <tr> <td>Normal: ██████████ 80%</td> <td>Staccato: ██████ 40%</td> </tr> <tr> <td>Tenuto: ██████████ 99%</td> <td>Staccatissimo: ████ 20%</td> </tr> </table> Manual: For freely setting the gate time. Touch “Manual” and close the pop-up window by touching “OK,” then set the gate time to any desired percentage by using the Data dial.	Normal: ██████████ 80%	Staccato: ██████ 40%	Tenuto: ██████████ 99%	Staccatissimo: ████ 20%				
Normal: ██████████ 80%	Staccato: ██████ 40%									
Tenuto: ██████████ 99%	Staccatissimo: ████ 20%									

⑦	Note Type, Note Indication	Touching [Note Type] repeatedly will alternate the type of the note indications at right in order: normal, dotted, and triplet. Select one of three types, then select (turn on) one of the note indications with which the next note is input. If you touch the selected note indication (which is turned on) again, a rest will be input with the corresponding length.
⑧	Delete	Deletes the selected data.

■ Example of Step Recording — Melodies

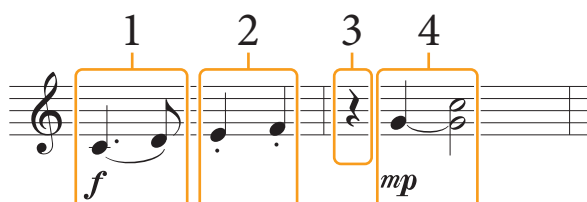

- The numbers shown in the illustration correspond to the following operation step numbers.
- The illustration given here is just a sample. Since the music score (called up via [Menu] → [Score]) is generated from recorded MIDI data, it may not appear exactly the same as shown above. Non-note musical performance symbols will not be shown in the Score display, even if you've entered them.

This section describes the instructions on inputting the melodies of the above notation via the Step Recording. Before starting, note the following points:

- To input the note with the tie in step 4, you need to operate without releasing the key. Proceed with the operations, reading the instructions carefully.
- Before inputting notes as described below, select the desired Voice by using the Voice buttons. Even if it has already been selected, you need to re-select the same Voice to input the Voice number to the Event List. Keep in mind that only note and Voice selection events can be input with Step Recording.

1 Enter the first and second notes with a slur.

- 1-1 Touch [Velocity] to select “*f*.”
- 1-2 Touch [Length] to select “99% (Tenuto).”
- 1-3 Touch [Note Type] once or twice to call up the dotted note type.
- 1-4 Touch the dotted quarter-note length (♩.) to turn it on.
- 1-5 Press the C3 key.

With the operations above, the first note has been entered. Next, enter the second note.

- 1-6 Touch [Note Type] once or twice to call up the normal note indications.
- 1-7 Touch the eighth-note length (♪) to turn it on.
- 1-8 Press the D3 key.

The first and second notes are entered with a slur.

2 Enter the next notes with staccato.

- 2-1 Touch [Length] to select “40% (Staccato).”
- 2-2 Touch the quarter-note length (♩) to turn it on.
- 2-3 Play the keys E3 and F3 in order.

The first measure has been completed.

3 Enter a quarter-note rest.

Touch the quarter-note (♩), that has been turned on, just once to input a quarter-note rest.

Be careful not to touch the same note (which is turned on) several times. Doing so results in multiple rest being input for the corresponding times. Rests are not actually indicated as such in the Event List, but you can confirm whether any have been input or not by checking the Song Position.

4 Enter the next notes and apply a tie.

4-1 Touch [Velocity] to select “*mp*.”

4-2 Touch [Length] to select “80% (Normal).”

4-3 While holding G3 key on the keyboard, touch quarter-note (♩).

Do not release the G3 key yet. Keep holding it while executing the following steps.

4-4 While holding the G3 key, press the C4 key.

Do not release the G3 and C4 keys yet. Keep holding the notes while executing the following step.

4-5 While holding the keys G3 and C4, touch half-note (♪).

After touching half-note (♪), release the keys.

The second measure has been completed.

5 Press the SONG CONTROL [■](STOP) button to return to the top of the Song, then hear the newly entered Song by pressing the [▶ / ■■](PLAY/PAUSE) button.

Recording Chord/Section Change Events via Step Recording

The explanations here apply when “Chord” is selected in step 5 on [page 62](#). With [Step Rec] turned on at the bottom left of the display, you can input the Chord/Section Change events for Style playback one by one.

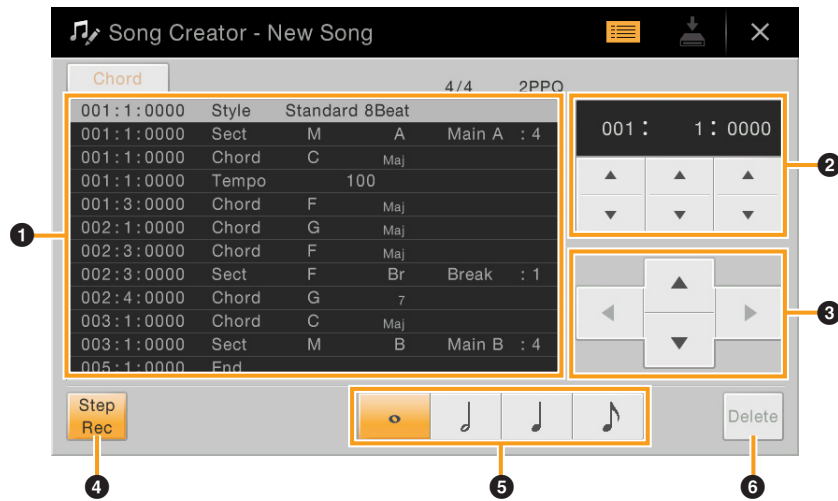

NOTE (CVP-709 only) The Audio part of an Audio Style cannot be recorded.

■ Control Names and Functions

①	Event List	Indicates events such as Chord and Section changes which have been input. For details, refer to page 69 .
②	Song Position (Measure: Beat: Clock)	Indicates the current Song position. Events such as Chord and Section change you have input are recorded at the position indicated here. You can change the current position by touching [▲] or [▼] below the Measure, Beat, and Clock* indications respectively. *Clock Smallest unit for the Song position and note length. A quarter note consists of 1920 clocks.
③	Cursor	Lets you move the cursor position.
④	Step Rec	Turning this on shows the Step Recording display, and turning it off shows the Song Edit display.
⑤	Note Indications	Select one of the four note lengths for inputting the next event.
⑥	Delete	Deletes the selected data.

■ Example of Step Recording — Chord/Section Events

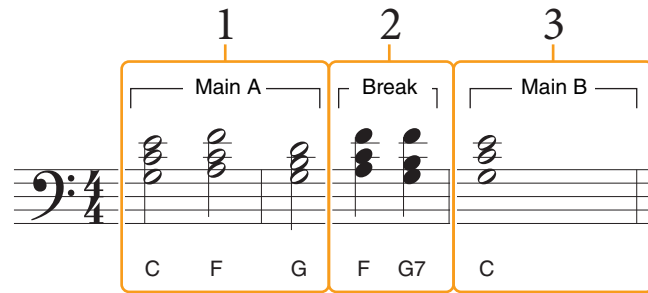

* The numbers shown in the illustration correspond to the following operation step numbers.

These instructions show how to input the Chord/Section change events of the above notation via Step Recording. Before starting, note the following points:

- Turn off the STYLE CONTROL [AUTO FILL IN] button on the panel.
- Select a conventional 4-beat Style.

1 Enter the chords for the Main A section.

- 1-1 Press the MAIN VARIATION [A] button.
- 1-2 Touch the half-note length (♩) to turn it on.
- 1-3 Play the chords C, F and G in the chord section of the keyboard.

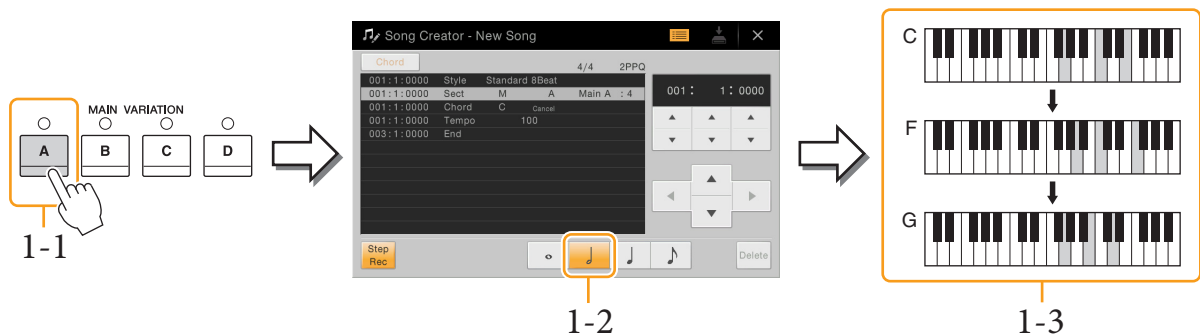

2 Enter the chords for the Break section.

- 2-1 Press the [BREAK] button.
- 2-2 Touch the quarter-note length (♩) to turn it on.
- 2-3 Play the chords F and G7 in the chord section of the keyboard.

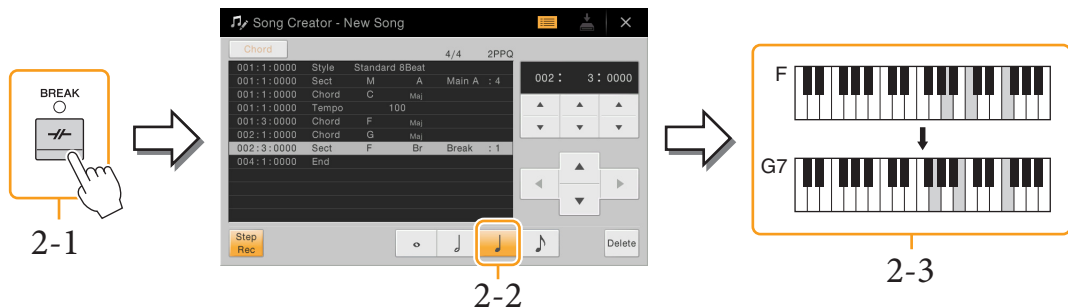

NOTE To enter fill-ins, turn the [AUTO FILL IN] button to on, and simply press the desired MAIN VARIATION [A] – [D] button.

3 Enter the chords for the Main B section.

- 3-1 Press the MAIN VARIATION [B] button.
- 3-2 Touch the whole-note length (●) to turn it on.
- 3-3 Play the chord C in the chord section of the keyboard.

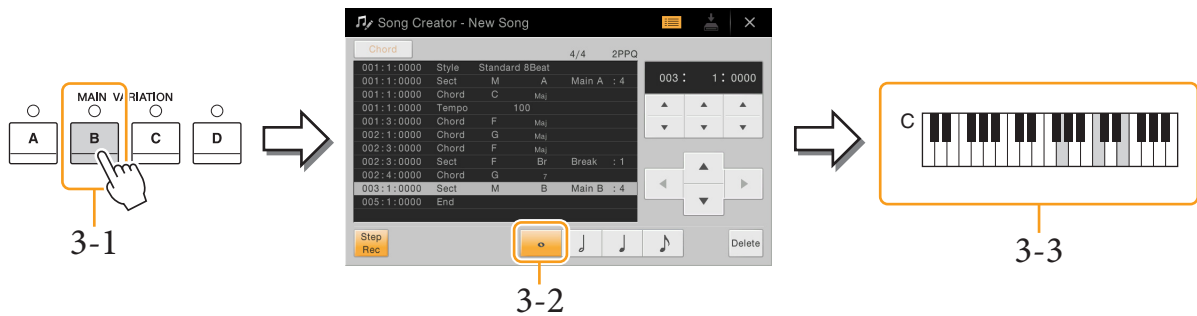

The Chord and Section change events are now entered.

- 4 Press the SONG CONTROL [■](STOP) button to return to the top of the Song, then listen to the newly entered Song by pressing the [▶/■](PLAY/PAUSE) button.
- 5 Touch and turn off [Step Rec] to call up the Song Edit display.
- 6 Touch [Expand] at the upper left of the Song Edit display to convert the Chord/Section change events to the Song data.



With the operations above (steps 1 – 3), only Chord and Section change events are recorded, meaning that the actual Song data has not been created and the Style part can produce no sound even if you start Song playback after exiting from the Song Creator. Accordingly, make sure to execute the Expand function after you finish inputting. If you have not finished inputting, save the Song to maintain the recorded events then continue inputting additional events as desired in the future.

Editing the Recorded Data

The explanations here apply to step 5 on page 62. From the Song Edit display, you can edit each of the events such as Note data and Voice selection which are created via Realtime Recording or Step Recording.

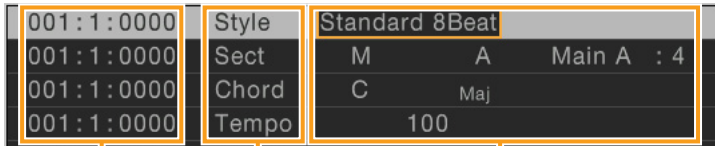

<p>❶</p>	<p>Editing Target</p>	<p>Specifies the Editing Target.</p> <ul style="list-style-type: none"> • Ch 1 – Ch 16: When one of these is selected, you can edit the channel data. • SysEx: Lets you edit System Exclusive data which applies to all channels. • Lyrics: Lets you edit Lyrics data. • Chord: Lets you edit Chord/Section change events for Style playback. 																				
<p>❷</p>	<p>Expand</p>	<p>This is shown only when “Chord” is selected above, and lets you convert the Chord/Section change events you input in the Step Recording display to actual sounded note data. Make sure to execute this function when finalizing Song data. If you exit from the Song Creator without executing this function, starting Song playback produces no sound of the Style part.</p>																				
<p>❸</p>	<p>Event List</p>	<p>In this area, the events of the Song data are listed and can be edited. Each line shows one event.</p>  <p>Indicates the Song position (measure: beat: clock) of the corresponding event. Indicates the event type. Indicates the event value or detail.</p> <p>Depending on the Editing Target above (❶), the listed and editable events differ as described below.</p> <p>■ When the Editing Target is set to one of “Ch1” – “Ch16”:</p> <table border="1" data-bbox="454 1025 1439 1585"> <tr> <td>Note</td> <td>An individual note within a Song. Includes the note name which corresponds to the key which was played, plus a velocity value based on how hard the key is played, and the gate time value (the length of a note).</td> </tr> <tr> <td>Ctrl (Control Change)</td> <td>Settings to control the Voice, such as volume, pan, filter and effect depth (edited via the Mixer), etc.</td> </tr> <tr> <td>Prog (Program Change)</td> <td>MIDI program change number for selecting a Voice.</td> </tr> <tr> <td>P.Bnd (Pitch Bend)</td> <td>Data for changing the pitch of a Voice continuously.</td> </tr> <tr> <td>A.T. (Aftertouch)</td> <td>This event is generated when pressure is applied to a key after the key is pressed. Note that the keyboard of this instrument does not feature Aftertouch, although Aftertouch values can be entered here.</td> </tr> </table> <p>■ When the Editing Target is set to “SysEx”:</p> <table border="1" data-bbox="454 1646 1439 2067"> <tr> <td>ScBar (Score Start Bar)</td> <td>Determines the top measure number as the starting point of the Song data.</td> </tr> <tr> <td>Tempo</td> <td>Determines the tempo value.</td> </tr> <tr> <td>Time (Time signature)</td> <td>Determines the time signature</td> </tr> <tr> <td>Key (Key signature)</td> <td>Determines the key signature, as well as the major/minor setting, for the music score shown on the display.</td> </tr> <tr> <td>XGPrm (XG parameters)</td> <td>Allows you to make various detailed changes to the XG parameters. Refer to the “MIDI Reference” (MIDI Data Format) on the website.</td> </tr> </table>	Note	An individual note within a Song. Includes the note name which corresponds to the key which was played, plus a velocity value based on how hard the key is played, and the gate time value (the length of a note).	Ctrl (Control Change)	Settings to control the Voice, such as volume, pan, filter and effect depth (edited via the Mixer), etc.	Prog (Program Change)	MIDI program change number for selecting a Voice.	P.Bnd (Pitch Bend)	Data for changing the pitch of a Voice continuously.	A.T. (Aftertouch)	This event is generated when pressure is applied to a key after the key is pressed. Note that the keyboard of this instrument does not feature Aftertouch, although Aftertouch values can be entered here.	ScBar (Score Start Bar)	Determines the top measure number as the starting point of the Song data.	Tempo	Determines the tempo value.	Time (Time signature)	Determines the time signature	Key (Key signature)	Determines the key signature, as well as the major/minor setting, for the music score shown on the display.	XGPrm (XG parameters)	Allows you to make various detailed changes to the XG parameters. Refer to the “MIDI Reference” (MIDI Data Format) on the website.
Note	An individual note within a Song. Includes the note name which corresponds to the key which was played, plus a velocity value based on how hard the key is played, and the gate time value (the length of a note).																					
Ctrl (Control Change)	Settings to control the Voice, such as volume, pan, filter and effect depth (edited via the Mixer), etc.																					
Prog (Program Change)	MIDI program change number for selecting a Voice.																					
P.Bnd (Pitch Bend)	Data for changing the pitch of a Voice continuously.																					
A.T. (Aftertouch)	This event is generated when pressure is applied to a key after the key is pressed. Note that the keyboard of this instrument does not feature Aftertouch, although Aftertouch values can be entered here.																					
ScBar (Score Start Bar)	Determines the top measure number as the starting point of the Song data.																					
Tempo	Determines the tempo value.																					
Time (Time signature)	Determines the time signature																					
Key (Key signature)	Determines the key signature, as well as the major/minor setting, for the music score shown on the display.																					
XGPrm (XG parameters)	Allows you to make various detailed changes to the XG parameters. Refer to the “MIDI Reference” (MIDI Data Format) on the website.																					



③	Event List	Sys/Ex. (System Exclusive)	Displays the System Exclusive data in the Song. Keep in mind that you cannot create new data or change the contents of the data here; however, you can delete, cut, copy, and paste the data.
		Meta (Meta event)	Displays the SMF meta events in the Song. Keep in mind that you cannot create new data or change the contents of the data here; however, you can delete, cut, copy, and paste the data.
		■ When the Editing Target is set to “Lyrics”:	
		Name	Allows you to enter the Song name.
		Lyrics	Allows you to enter lyrics.
		Code	CR: Enters a line break in the lyrics text. LF: Clears the currently displayed lyrics and displays the next set of lyrics.
		■ When the Editing Target is set to “Chord”:	
		Style	Style name
		Tempo	Tempo setting
		Chord	Chord root, Chord type, On Bass Chord
		Sect (Section)	Style Section (Intro, Main, Fill In, Break, Ending)
		OnOff	On/off status for each part (channel) of the Style
		CH.Vol (Channel Volume)	Volume for each part (channel) of the Style
S.Vol (Style volume)	Overall volume of the Style		
④	Song Position (Measure: Beat: Clock)	Indicates the current Song position. The events you input are recorded at the position indicated here. You can change the current position by touching [▲] or [▼] below the Measure, Beat, and Clock* indications respectively. *Clock Smallest unit for the Song position and note length. A quarter note consists of 1920 clocks.	
⑤	Cursor	Lets you move the cursor position.	
⑥	Step Rec	Turning this on shows the Step Recording display, and turning it off shows the Song Edit display.	
⑦	Event Filter	Calls up the Event Filter window, letting you select only the events you wish to be shown in the event list.  : Checkmark all items.  : Remove checkmarks from all items.  : Invert checked/unchecked for all items.	
⑧	Multi Select	After turning this on, use the Cursor buttons (⑤) on the display to select multiple events.	
⑨	Cut/Copy/Paste	Use these when you want to copy or move the selected events.	
⑩	Insert	Adds a new event.	
⑪	Delete	Deletes the selected events.	
⑫	Cancel	Cancels editing and restores the original value.	
⑬	-/+	Increases or decreases the value of the current cursor position by 1.	

Channel Edit — Editing Channel Data

The explanations here apply to step 6 on [page 62](#). The Channel Edit display lets you correct or convert the specific portion of the Song data.

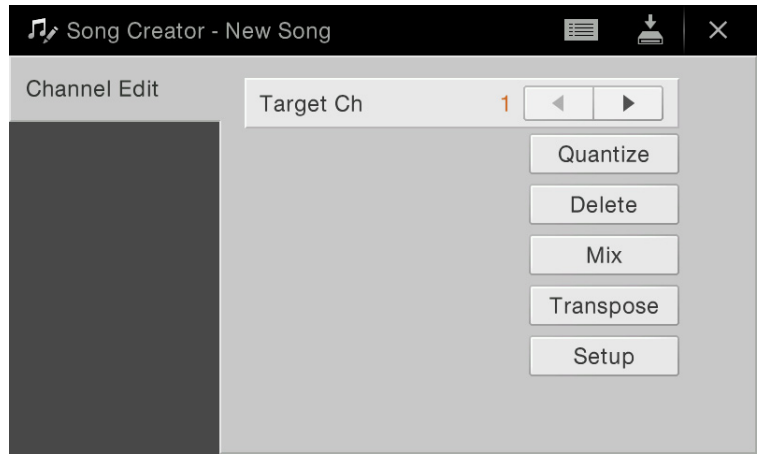
After editing the desired parameter, touch [Execute] to actually enter the edits for each setup window. When execution is completed, this button changes to [Undo], letting you restore the original data if you are not satisfied with the results. The Undo function only has one level; only the previous operation can be undone.

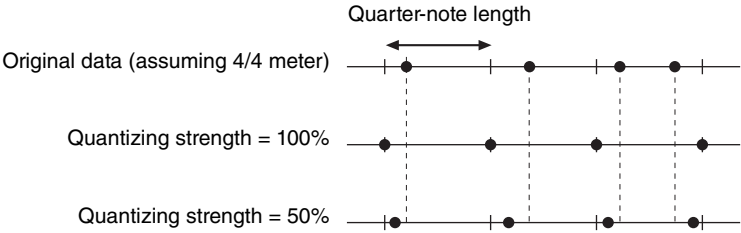

Target Ch	Select the target channel to be edited.										
Quantize	<p>The Quantize function allows you to align the timing of all the notes in a channel. For example, if you record the musical phrase shown below, you may not play it with absolute precision, and your performance may have been slightly ahead of or behind the precise timing. Quantize is a convenient way of correcting for this.</p> 										
Size	<p>Selects the quantize size (resolution). For optimum results, you should set the Quantize size to the shortest note value in the channel. For example, if eighth notes are the shortest in the channel, you should use eighth note as the Quantize size.</p>  <p style="text-align: center;">After 1/8 note quantization</p> <p>Settings:</p> <table style="width: 100%; text-align: center;"> <tr> <td> 1/4 note</td> <td> 1/8 note</td> <td> 1/16 note</td> <td> 1/32 note</td> <td> 1/16 note+ 1/8 note triplet*</td> </tr> <tr> <td> 1/4 note triplet</td> <td> 1/8 note triplet</td> <td> 1/16 note triplet</td> <td> 1/8 note+ 1/8 note triplet*</td> <td> 1/16 note+ 1/16 note triplet*</td> </tr> </table> <p>The three Quantize settings marked with asterisks (*) are exceptionally convenient, since they allow you to quantize two different note values at the same time. For example, when the straight eighth notes and eighth notes triplet are contained in the same channel, if you quantize by the straight eighth notes, all notes in the channel are quantized to straight eighth notes — completely eliminating any triplet feel. However, if you use the eighth note + eighth note triplet setting, both the straight and triplet notes will be quantized correctly.</p>	 1/4 note	 1/8 note	 1/16 note	 1/32 note	 1/16 note+ 1/8 note triplet*	 1/4 note triplet	 1/8 note triplet	 1/16 note triplet	 1/8 note+ 1/8 note triplet*	 1/16 note+ 1/16 note triplet*
 1/4 note	 1/8 note	 1/16 note	 1/32 note	 1/16 note+ 1/8 note triplet*							
 1/4 note triplet	 1/8 note triplet	 1/16 note triplet	 1/8 note+ 1/8 note triplet*	 1/16 note+ 1/16 note triplet*							

Quantize	Strength	<p>Determines how strongly the notes will be quantized. A setting of 100% produces exact timing. If a value less than 100% is selected, notes will be moved toward the specified quantization beats according to the specified percentage. Applying less than 100% quantization lets you preserve some of the “human” feel in the recording.</p> 	
Delete	<p>You can delete the data of the specified channel in the Song. Checkmark (touch) the desired channel whose data you wish to delete, then touch [Execute] to actually delete the data.</p>		
Mix	<p>This function lets you mix the data of two channels and place the results in a different channel. It also lets you copy the data from one channel to another.</p>		
	Source 1 Ch	<p>Determines the MIDI channel (1 – 16) to be mixed. All MIDI events of the channel specified here are copied to the destination channel.</p>	
	Source 2 Ch	<p>Determines the MIDI channel (1 – 16) to be mixed. Only note events of the channel specified here are copied to the destination channel. Besides the values 1 – 16, there is a “Copy” setting that allows you to copy the data from Source 1 to the destination channel.</p>	
Destination Ch	<p>Determines the channel into which the mix or copy results will be placed.</p>		
Transpose	<p>This allows you to transpose the recorded data of individual channels up or down by a maximum of two octaves in semitone increments.</p>		
	1-16	<p>Sets the Transpose value for each channel.</p>	
	All -	<p>Decreases the Transpose value for all channels by 1.</p>	
	All +	<p>Increases the Transpose value for all channels by 1.</p>	
	<p>NOTE Make sure not to transpose channels 9 and 10. In general, Drum kits are assigned to these channels. If you transpose the channels of Drum kits, the instruments assigned to each key will be changed.</p>		
Setup	<p>The current settings of the Mixer display and other panel settings can be recorded to the top position of the Song as the Setup data. The Mixer and panel settings recorded here are automatically recalled when the Song starts.</p> <p>Checkmark the items of playback features and functions that you wish to automatically be called up along with the selected Song.</p> <p>NOTE Before executing the Setup operation, move the Song position to the top of the Song by pressing the SONG [STOP] button.</p>		

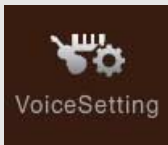

Voice Settings

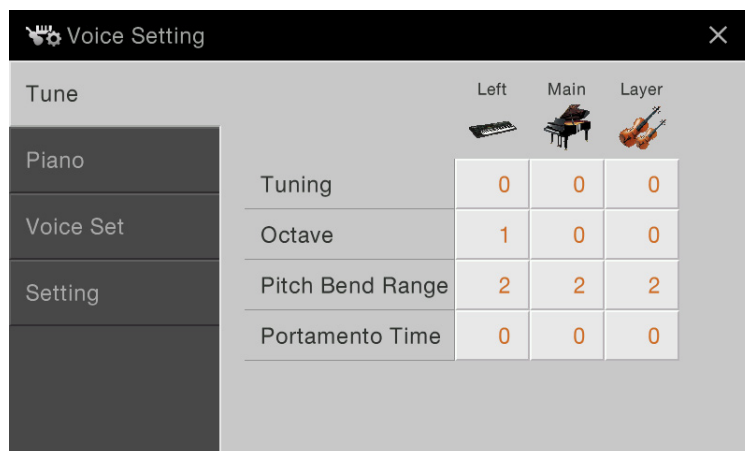

Tune

Lets you adjust the pitch related parameters for each keyboard part.

Tuning	Determines the pitch of each keyboard part. If a VRM Voice is selected as the Main part, the tuning of the resonance sound of all VRM Voices is set to the same as the tuning of the Main part. If a Voice other than a VRM Voice is selected as the Main part, the tuning of the resonance sound of any other VRM Voices is set to 0.
Octave	Determines the range of the pitch change in octaves, over two octaves up or down for each keyboard part.
Pitch Bend Range	Determines the range of the Pitch Bend for each keyboard part in semitones when the “Pitch Bend” or “Glide” function is assigned to a pedal (page 39).
Portamento Time	Portamento is a function that creates a smooth transition in pitch from the first note played on the keyboard to the next. The Portamento Time determines the pitch transition time. Higher values result in a longer pitch change time. Setting this to “0” results in no effect. This parameter is available for keyboard parts which are set to “Mono” (page 43).

Piano

Page 1/2

Lets you set the Piano-related parameters which are available only for the VRM Voices. Refer to the Owner's Manual "Playing Realistic Resonance-enhanced Piano Sounds (VRM Voices)."

Page 2/2

Lets you set the Piano-related parameters which are available only for some of the piano Voices in the "Piano" category (listed in the "Target Voice List" on [page 74](#)).

Tuning Curve	<p>Determines the tuning curve. Select "Flat" if you want the tuning curve of the piano Voice to most accurately match that of other instruments Voices.</p> <ul style="list-style-type: none"> • Stretch: Tuning curve often employed by piano tuners to make the upper octaves sound more natural. • Flat: Tuning curve in which the frequencies of the notes are repeated for each octave over the entire keyboard range.
Key Off Sampling	Adjusts the volume of the key-off sound (the subtle sound that occurs when you release a key).

Target Voice List

Sub Category Name	Voice Name	Key Off Sampling	Tuning Curve
VRM Piano	CFX Grand	○	○
	Pop Grand	○	—
	Studio Grand	○	—
	Bright Piano (CVP-709 only)	○	—
	Ambient Piano	○	—
	Rock Piano	○	—
	Stage Piano	○	—
	Grand Piano 1octave	○	—
	Grand Piano 2octaves	○	—
	Cocktail Piano	○	—
Grand Piano	CFX Grand	○	—
	Pop Grand	○	—
	Studio Grand	○	—
	Bright Piano (CVP-709 only)	○	—
	Ambient Piano	○	—
	Rock Piano	○	—
	Stage Piano	○	—
	Grand Piano 1octave	○	—
	Grand Piano 2octaves	○	—
	Cocktail Piano	○	—

○: Available, —: Not available

Voice Set

Each Voice is linked to its default Voice Set parameter settings, equivalent to those in the Voice Edit display (page 42) for the Voices other than the Organ Flutes Voices. Although usually these settings are automatically called up by selecting a Voice, you can also disable this feature. For example, if you want to change the Voice yet keep the same Harmony effect, remove the checkmark of “Keyboard Harmony.”





Setting



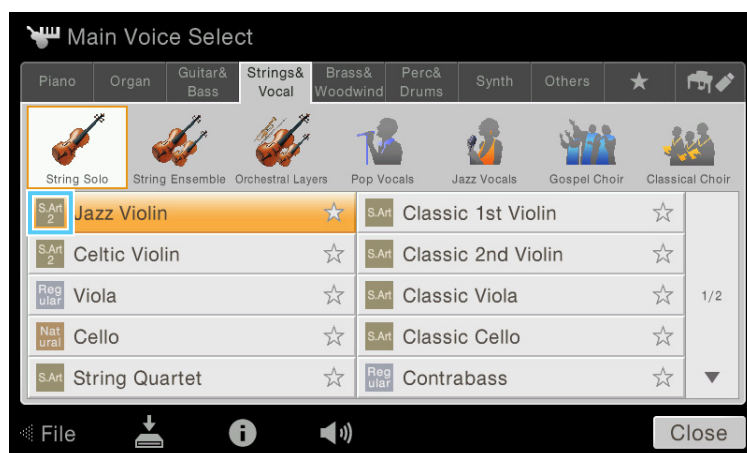





<p>Category Button</p>	<p>Determines how the Voice Selection display is opened when one of the VOICE category buttons is pressed.</p> <ul style="list-style-type: none"> • Open & Select: Opens the Voice Selection display with the previously selected Voice in the Voice category automatically selected (when one of the VOICE category buttons is pressed). • Open Only: Opens the Voice Selection display with the currently selected Voice (when one of the VOICE category buttons is pressed).
<p>S.Art2 Auto Articulation (only for CVP-709)</p>	<p>Determines whether articulation is added to S.Articulation2! Voices automatically.</p>

Voice Characteristics

In the Voice Selection display, icons defining the Voice characteristics are indicated at left of the Voice name, and detailed information for the selected Voice can be called up by touching  (Information).



<p> VRM</p>	<p>Refer to the Owner’s Manual.</p>
<p> Natural!</p>	<p>Natural! Voices are high quality sounds based on many specialist sampling techniques. They are especially suited to recreating Piano and other keyboard instruments.</p>
<p> S.Articulation!  S.Articulation2! (only for CVP-709)</p>	<p>Refer to the Owner’s Manual.</p>
<p> Live!</p>	<p>Live! Voices feature stereo sampling, to reproduce accurately the stereo image of an acoustic instrument, as well as the ambience of the room it was recorded in.</p>

 Cool!	Cool! Voices reproduce the complex characteristics of Electric Instruments, by utilizing sophisticated programming techniques in both voicing, and the use of DSP effects.
 Sweet!	Sweet! Voices are acoustic instruments which feature the sampled vibrato of the original player, creating a far more realistic and emotional performance than synthesized vibrato.
 Drums	Drum & Percussion instruments are mapped across the keyboard so you can play them directly, or use in music production. For information about what sound is assigned to each key, refer to the separate “Data List” (Drum/key Assignment List).
 Live!Drums	Stereo sampling is used for these high definition Drum and Percussion instruments, which are mapped across the keyboard so you can play them directly, or use in music production.
 SFX	Special percussion and sound effects are mapped across the keyboard, so you can play them directly, or use in music production. For information about what sound is assigned to each key, refer to the separate “Data List” (Drum/key Assignment List).
 Live!SFX	Stereo sampling is used for these high definition special percussion and sound effects, which are mapped across the keyboard so you can play them directly, or use in music production.
 Organ Flutes!	OrganFlutes! lets you create your own Organ registrations, by combining Organ Flute Footages at different pitches, just like a real organ. See page 46 for details.
 MegaVoice	<p>MegaVoice is a special Voice format designed for use in styles and songs, not for live performance. Different velocity ranges are used to select dramatically different playing styles simultaneously, and without changing the voice.</p> <p>Actual sound maps for the MegaVoices are given in the separate “Data List” booklet.</p> <p>NOTE MegaVoices are not compatible with other models. Any Song or Style data you’ve created on this instrument using the MegaVoices will not sound properly when played back on other instruments which do not feature the same MegaVoices.</p> <p>NOTE MegaVoices will sound differently depending on the keyboard range, velocity, touch, etc. Hence, if you apply the Keyboard Harmony effect, change the transpose setting or change the Voice Set parameters, unexpected or undesired sounds may result.</p>
 Regular	Other Voices including GM Voices and XG Voices.

Selecting GM/XG or MegaVoices

This instrument features GM Voices, XG Voices, and MegaVoices. These Voices can be called up from the “Others” category in the Voice Selection display.

- 1 From the Home display, touch the Voice name of the desired part to call up the Voice Selection display.

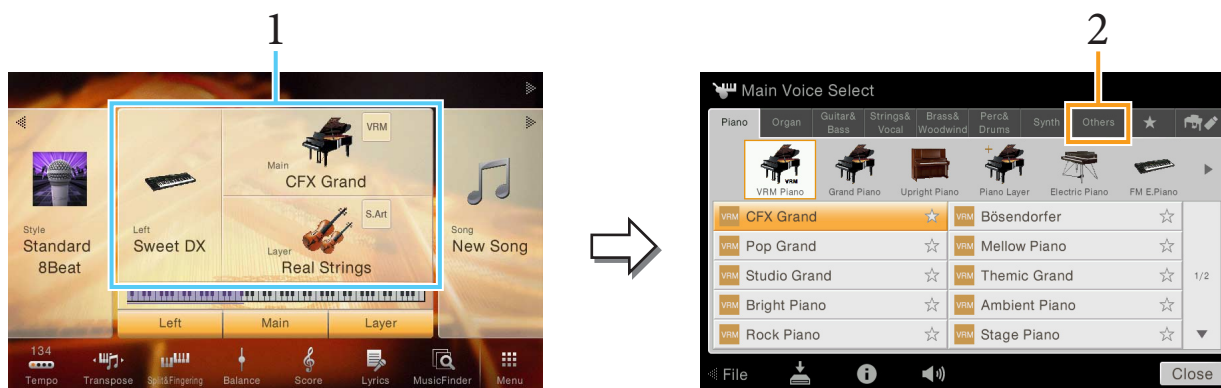

- 2 Touch the tab of the “Others” category.

- 3 Touch  (Above) several times if necessary, to call up the root directory of “Others.”

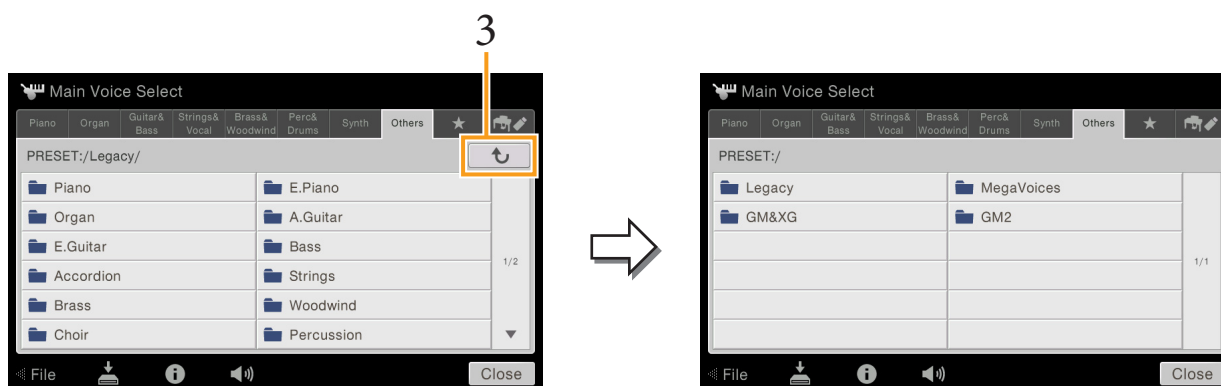

- 4 Touch the desired category, such as “GM&XG” and “MegaVoices.”

NOTE You can find the “Legacy” folder in this display. This folder contains previous Yamaha Clavinova Voices (such as CVP-609, 605 etc.) for data compatibility with other models.

- 5 Select the desired Voice.



Style Playback Related Settings

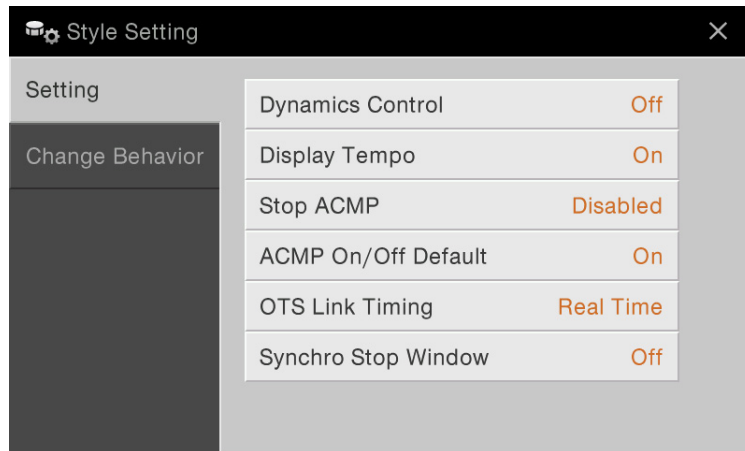

Setting

Dynamics Control	<ul style="list-style-type: none"> • Off: The Style volume does not respond to your playing strength. • Narrow: The Style volume changes over a narrow range in response to your playing strength. In other words, you must play very strongly or softly to have the volume change. • Medium: The Style volume changes normally in response to your playing strength. • Wide: The Style volume changes over a wide range in response to your playing strength. In other words, playing strongly or softly produces greater changes in the volume.
Display Tempo	Turns on or off the tempo indication for each Style on the Style Selection display.
Stop ACMP	<p>When the [ACMP ON/OFF] button is on, [SYNC START] is off, and this parameter is set to the value other than “Disabled,” you can play chords in the chord section of the keyboard with the Style stopped, and still hear the accompaniment chord. In this condition — called “Stop Accompaniment” — any valid chord fingerings are recognized and the chord root/type are shown in the Style area of the Home display. Here, you can determine whether the chord played in the chord section will sound or not in the Stop Accompaniment status.</p> <ul style="list-style-type: none"> • Disabled: Disables the Stop Accompaniment feature. When Style playback is stopped, any pressed notes in the chord section of the keyboard will not be recognized as chords. • Off: The chord played in the chord section will not sound. • Style: The chord played in the chord section will sound via the Voices for the Pad part and the Bass channel of the selected Style. • Fixed: The chord played in the chord section will sound via the specified Voice, regardless of the selected Style. <p>NOTE When the selected Style contains MegaVoices, unexpected sounds may result when this is set to “Style.”</p> <p>NOTE If you record a Song using the Stop Accompaniment, both the Voice that is sounded and the chord data will be recorded when set to “Style,” and only the chord data will be recorded when set to “Off” or “Fixed.”</p> <p>NOTE When this is set to “Disabled,” chords are not recognized while the Style is stopped. This is why both Vocal Harmony (with the Chordal mode) and Keyboard Harmony are not applied even if you play a chord in the chord section of the keyboard while the Style is stopped.</p>

ACMP On/Off Default	Determines whether the [ACMP ON/OFF] button is on or off when the power is turned on.
OTS Link Timing	This applies to the OTS Link function. This parameter determines the timing in which the One Touch Settings change with the MAIN VARIATION [A] – [D] change. (The [OTS LINK] button must be on.) <ul style="list-style-type: none"> • Real Time: One Touch Setting is immediately called up when you press a MAIN VARIATION button. • Next Bar: One Touch Setting is called up at the next measure, after you press a MAIN VARIATION button.
Synchro Stop Window	This determines how long you can hold a chord before the Synchro Stop function is automatically cancelled. When the [SYNC STOP] button is turned on and this is set to a value other than “Off,” the Synchro Stop function is automatically cancelled if you hold a chord for longer than the time set here. This conveniently resets Style playback control to normal, letting you release the keys and still have the Style play. In other words, if you release the keys sooner than the time set here, the Synchro Stop function works.

Change Behavior

Section Set	Determines the default section that is automatically called up when selecting different Styles (when Style playback is stopped). When set to “Off” and Style playback is stopped, the active section is maintained even if the different Style is selected. When any of the MAIN A–D sections is not included in the Style data, the nearest Section is automatically selected. For example, when MAIN D is not contained in the selected Style, MAIN C will be called up.
Tempo	This determines whether the tempo changes or not when you change the Style. <ul style="list-style-type: none"> • Lock: Regardless of playback status, the tempo setting of the previous Style is maintained. • Hold: While the Style is playing back, the tempo setting of the previous Style is maintained. While the Style is stopped, the tempo changes to that of the default tempo of the selected Style. • Reset: Regardless of playback status, the tempo changes to that of the default tempo for the selected Style.
Part On/Off	This determines whether the Style Channel on/off status changes or not when you change the Style. <ul style="list-style-type: none"> • Lock: Regardless of playback status, the Channel on/off status of the previous Style is maintained. • Hold: While the Style is playing back, the Channel on/off status of the previous Style is maintained. While the Style is stopping, all Channels of the selected Style are set to on. • Reset: Regardless of playback status, all Channels of the selected Style are set to on.
Music Finder	Tempo This determines whether the tempo changes or not when you change the Style by using the Music Finder. <ul style="list-style-type: none"> • Lock: Regardless of playback status, the tempo setting of the previous Style is maintained. • Hold: While the Style is playing back, the tempo setting of the previous Style is maintained. While the Style is stopped, the tempo changes to that of the default tempo of the selected Style. • Reset: Regardless of playback status, the tempo changes to that of the default tempo of the selected Style.

Style Characteristics

On the Style Selection display, icons defining the Style characteristics are indicated at left of the Style name.

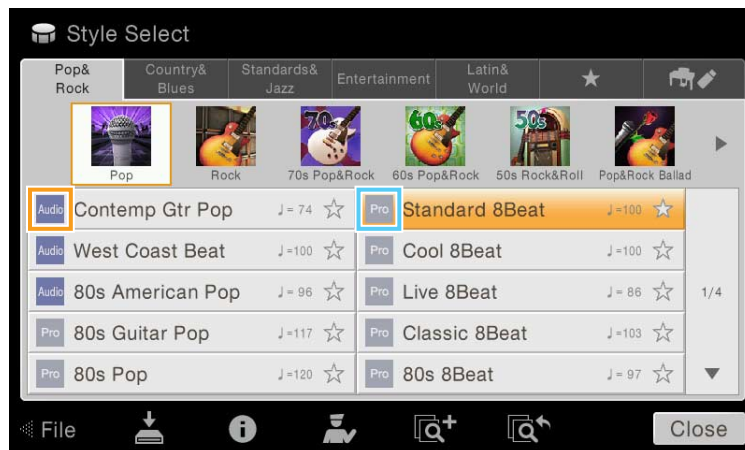

- **Audio (CVP-709 only):** Refer to the Owner's Manual.
- **Pro:** These Styles provide professional and exciting arrangements combined with perfect playability. The resulting accompaniment exactly follows the chords of the player. As a result, your chord changes and colorful harmonies are instantly transformed into lifelike musical accompaniment.
- **Session:** These Styles provide even greater realism and authentic backing by mixing in original chord types and changes, as well as special riffs with chord changes, with the Main sections. These have been programmed to add "spice" and a professional touch to your performances of certain songs and in certain genres. Keep in mind, however, that the Styles may not necessarily be appropriate or even harmonically correct for all songs and for all chord playing. In some cases for example, playing a simple major triad for a country song may result in a "jazzy" seventh chord, or playing an on-bass chord may result in inappropriate or unexpected accompaniment.
- **Free Play:** These Styles are characterized by rubato performance. You can perform freely with remarkably expressive accompaniment without being constrained by a strict tempo.
- **Pianist:** These special Styles provide piano-only accompaniment. Just by playing the proper chords with your left hand, you can automatically add complicated, professional-sounding arpeggios and bass/chord patterns.

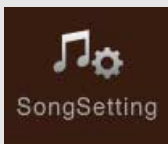

Song Settings Related to Playback/Recording

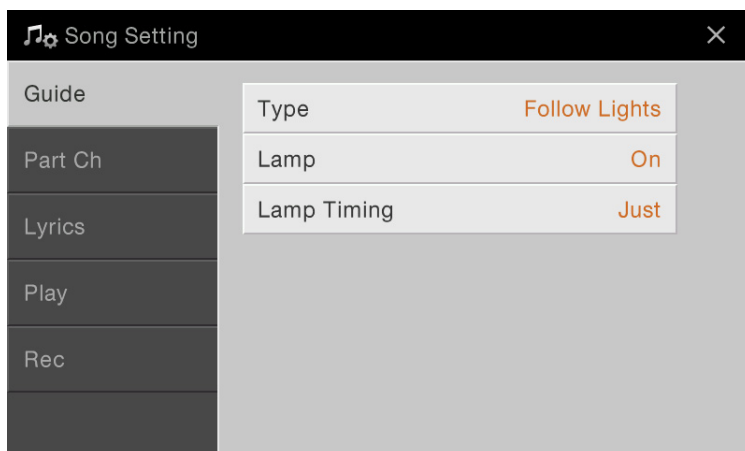

Guide

If you use the Guide function, the keyboard guide lamps indicate the notes (location and timing) for you to play. Also, when you sing along with a MIDI Song playback using a connected microphone, the instrument automatically adjusts the timing of the MIDI Song playback to match your vocal performance.

The Guide function can be turned on from the Song area (when expanded) of the Home display, Score display, Lyrics display and Text display. For instructions on how to use Guide function, refer to the Owner's Manual. This section covers the detailed parameters about the Guide function.

Type	<p>Lets you select the Guide type.</p> <ul style="list-style-type: none"> ■ Guide menu for keyboard practice <ul style="list-style-type: none"> • Follow Lights: With this function, the keyboard guide lamps indicate which notes you should play. Song playback pauses and waits for you to play. When you play the correct notes, Song playback continues. • Any Key: With this function, you can play the melody of a Song just by pressing a single key (any key is OK) in time with the rhythm. Song playback pauses and waits for you to play any key. Simply play a key on the keyboard in time with the music and Song playback continues. • Your Tempo: Basically the same as "Follow Lights." In addition, playback tempo will change to match the speed at which you are playing. ■ Guide menu for singing <ul style="list-style-type: none"> • Karao-Key: This function lets you control the Song playback timing with just one finger, while you sing along. This is useful for singing to your own performance. Song playback pauses, waiting for you to sing. Simply play a key on the keyboard (any key is fine) and Song playback continues.
Lamp	<p>Activates or deactivates the keyboard guide lamp.</p> <p>NOTE If the Guide Lamps do not light as intended in the "Part Ch" display, set the Right to "Ch1" then set the Left to "Ch2."</p>
Lamp Timing	<p>Determines the timing by which the keyboard guide lamps light.</p> <ul style="list-style-type: none"> • Just: The guide lamps light in time with the music, at the same timing you should play. • Next: The guide lamps light slightly ahead of the music, indicating the notes you should play next. The guide lamps flash if you fail to play the keys with the correct timing.

NOTE The Guide settings can be saved as a part of Song data (page 72). When you select the saved Song the next time, the corresponding Guide settings will also be called up.

Part Ch

Right	Determines which channel is assigned to the right-hand part.
Left	Determines which channel is assigned to the left-hand part.
Auto Set	When set to “On,” this automatically sets the proper MIDI channels for the right- and left hand parts pre-programmed in the commercially available Song data. Normally, this should be set to “On.”

Lyrics

Language	<p>Determines the language of the displayed lyrics.</p> <ul style="list-style-type: none"> • Auto: When the language is specified in the Song data, the lyrics are displayed accordingly. When the language is not specified in the Song data, the lyrics language is regarded as “International” below. • International: Handles the displayed lyrics as a western language. • Japanese: Handles the displayed lyrics as Japanese.
-----------------	---

Play

Repeat Mode	<p>Determines how playback of the current MIDI Song or Audio Song is repeated.</p> <ul style="list-style-type: none"> • Off: Plays through the selected Song, then stops. • Single: Plays through the selected Song repeatedly. • All: Continues playback through all the Songs in the specified folder repeatedly. • Random: Continues playback at random through all the Songs in the specified folder repeatedly. <p>NOTE The preset Songs in the “Follow Lights” folder contain the Guide settings. These Songs are inappropriate for use with the “All” or “Random” settings.</p>
Phrase Mark Repeat	Phrase Mark is a pre-programmed part of some Song data, which specifies a certain location (set of measures) in the Song. When this is “On,” the section corresponding to the specified Phrase Mark number is repeatedly played back. This parameter is available only when the MIDI Song containing Phrase Mark settings is selected.
Quick Start	On some commercially available MIDI Song data, certain settings related to the MIDI Song (such as Voice selection, volume, etc.) are recorded to the first measure, before the actual note data. When Quick Start is set to “On,” the instrument reads all initial non-note data of the Song at the highest possible speed, then automatically switches to the appropriate tempo at the first note. This allows you to start playback as quickly as possible, with a minimum pause for reading of data.
MIDI Song Fast Forward Type	<p>Determines the fast forward type of when pressing [▶▶] during MIDI Song playback.</p> <ul style="list-style-type: none"> • Jump: Pressing [▶▶] once instantly sets the playback position to the next measure without sounding. Holding [▶▶] scrolls forward continuously. • Scrub: Pressing and holding [▶▶] plays and sounds the MIDI Song at high speed.
USB MIDI Song Auto Open	When this is set to “On,” connecting the USB flash drive will call up the first MIDI Song in the USB flash drive.
Performance Assistant	Refer to page 83 .

Chord Detection Priority	<p>Determines the priority of the chords for accompaniment, either the ones contained in the MIDI Song being played back or the chord you've just played in the chord section of the keyboard.</p> <ul style="list-style-type: none"> • MIDI Song: Gives priority to the chords contained in the MIDI Song. • Keyboard: Gives priority to the chords you play in the chord section of the keyboard. Set this if you want to practice playing chords with MIDI Song playback. Once you play in the chord section during MIDI song playback, the instrument ignores the chords contained in the MIDI Song until the playback ends.
---------------------------------	--

Playing Backing Parts with the Performance Assistant Technology

This feature lets you play your own backing parts on the keyboard along with MIDI Song playback, and have them sound perfectly appropriate (even though the notes you play might be wrong).

1 Select a MIDI Song containing chord data.

The Performance Assistant Technology is applied only to MIDI Songs containing chord data. To confirm whether the selected Song contains chord data or not, call up the Home display with the Style area shown, then start playback of the Song. If the current Song contains chord data, the current chord type appears in the Style area. After stopping playback, go to the next step.

2 Call up the operation display via [Menu] → [SongSetting] → [Play].

3 Set the Performance Assistant to “On.”

NOTE Selecting a Song will turn off the Performance Assistant.

4 Press the SONG CONTROL [▶/||] (PLAY/PAUSE) button to start playback.

5 Play the keyboard.

Along with MIDI Song playback, try playing a bass line in the left hand area while playing various phrases or chords in the right hand area. Even if you do not know what notes should be played, don't worry and play any keys as desired! Only the harmonically “correct” notes matching the current chord are sounded, regardless of the notes you actually play.

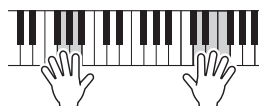

6 Press the SONG CONTROL [■] (STOP) button to stop playback.

Rec

Re-recording a Specific Section of the MIDI Song — Punch In/Out

When re-recording a specific section of an already-recorded MIDI Song, use the Punch In/Out function. In this method, only the data between the Punch In point and the Punch Out point is overwritten with the newly recorded data. Keep in mind that the notes before and after the Punch In/Out points are not recorded over, and you will hear them play back normally to guide you in the Punch In/Out timing.

1 Call up the operation display via [Menu] → [SongSetting] → [Rec] → Page 1/2.

2 Set the parameters such as how the Recording starts/stops and the Punch In/Out position.

NOTE The parameters here cannot be set while recording.

Mode	Rec Start	<p>Determines the recording start behavior.</p> <ul style="list-style-type: none"> • Normal: Overwrite recording starts when Song playback is started via the SONG [▶ /] (PLAY/PAUSE) button or when you play the keyboard in the Synchro Standby mode. • First Key On: The Song plays back normally, then starts overwrite recording as soon as you play the keyboard. • Punch In At: The Song plays back normally up to the beginning of the “Punch In At” measure specified in the Punch In/Out parameter below, then starts overwrite recording at that point.
Mode	Rec Stop	<p>Determines the recording stop behavior, or how data is handled after recording is stopped.</p> <ul style="list-style-type: none"> • Replace All: This deletes all data after the point at which recording is stopped. • Punch Out: The Song position at which recording is stopped is regarded as the Punch Out point. This setting maintains all data after the point at which recording is stopped. • Punch Out At: Actual overwrite recording continues until the beginning of the “Punch Out” measure specified in the Punch In/Out parameter below, at which point recording stops and normal playback continues. This setting maintains all data after the point at which recording is stopped.
Punch In/Out	Punch In At	Specifies the Punch In measure.
	Punch Out At	Specifies the Punch Out measure.
	Pedal Control	<p>When this is set to “On,” you can use the center pedal to control the Punch In and Punch Out points. While a Song is playing back, pressing (and holding) the center pedal instantly enables Punch In recording, while releasing the pedal stops recording (Punch Out). You can press and release the center pedal as often as you want during playback. Note that the current function assignment of the center pedal is cancelled when the Pedal Punch In/Out function is set to “On.”</p> <p>NOTE Pedal Punch In/Out operation may be reversed depending on the particular pedal you’ve connected to the instrument. If necessary, change the pedal polarity to reverse the control (page 38).</p>

3 Select a MIDI Song to be re-recorded.

4 Press the [●](REC) button to call up the Song Recording display, and then confirm that [Overwrite MIDI] is selected.

If the Channel area is not shown, touch [▶] at the left of “Channel.”

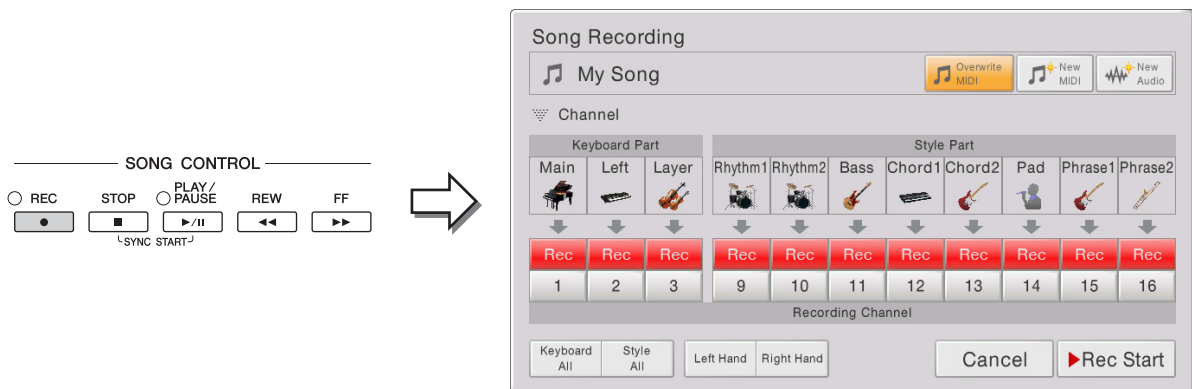

5 From the display, set the part or parts you intended to re-record to [Rec], and set all other parts to [Off].

NOTE For details about the recording channels, refer to the Owner’s Manual.

6 Press the SONG CONTROL [▶/||] (PLAY/PAUSE) button to start recording.

At the Punch In point specified in step 2, play the keyboard to start actual recording. At the Punch Out point specified in step 2, stop playing the keyboard.

7 Touch (Save) which appears in the Song area of the Home display to save the recorded Song.

NOTICE

The recorded Song data will be lost if you select another Song or turn the power to the instrument off without executing the Save operation.

Examples of re-recording with various Punch In/Out settings

This instrument features several different ways you use the Punch In/Out function. The illustrations below indicate a variety of situations in which selected measures in an eight-measure phrase are re-recorded.

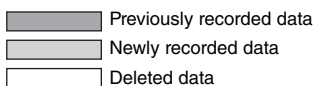
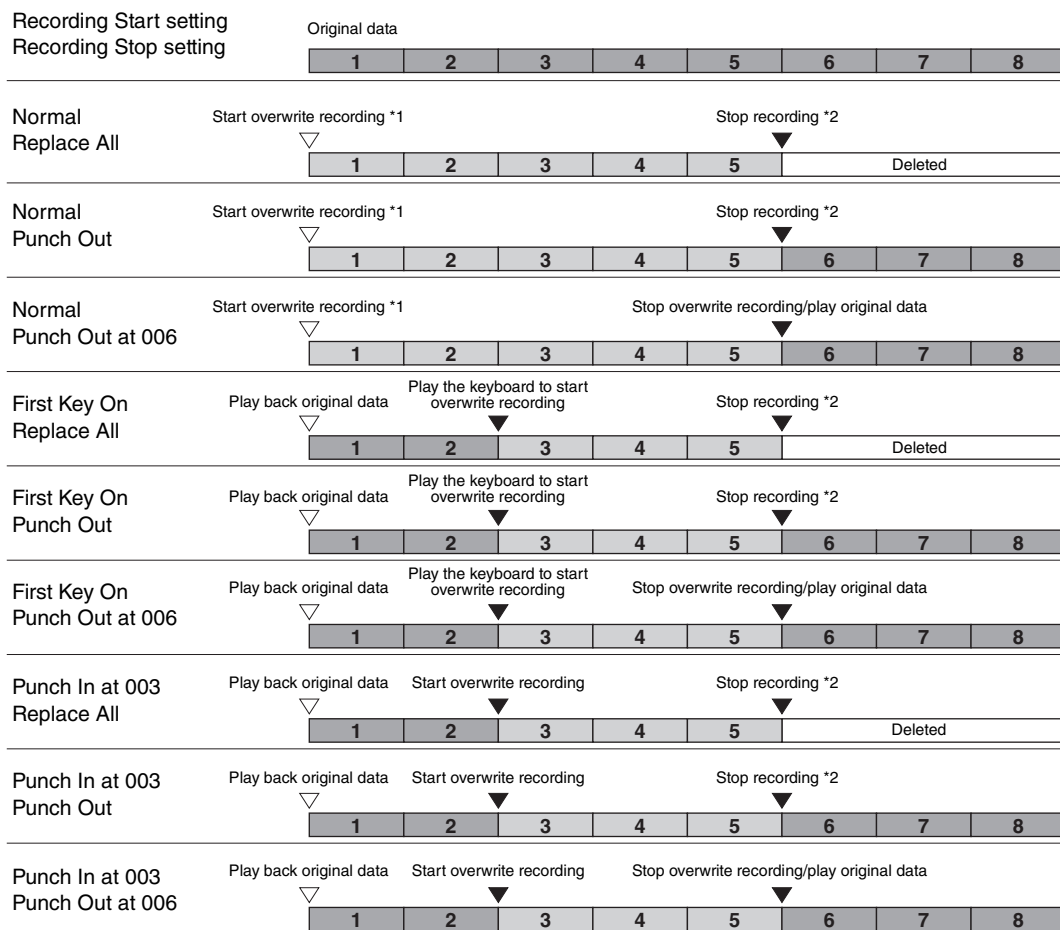

*1 To avoid overwriting measures 1 – 2, start recording from measure 3.

*2 To stop recording, press the [REC] button at the end of measure 5.

Setting the Audio File Format saved via Audio Recording

From the display called up via [Menu] → [SongSetting] → [Rec] → page 2/2, you can specify the Audio file format saved via the Audio recording.

<h3>Audio Rec Format</h3>	<ul style="list-style-type: none"> • WAV: Your performance will be recorded in WAV format which features higher audio quality than MP3, but the file size will be larger. • MP3 64/96/128/256/320kbps: Your performance will be recorded in MP3 format (MPEG-1 Audio Layer-3). The larger the value, the higher the quality, and the larger the data size.
---------------------------	--



Fine Tuning the Pitch

Master Tune – Fine Tuning the Pitch of the Entire Instrument

You can fine-tune the pitch of the entire instrument in 0.2 Hz steps —useful when you play the Clavinova along with other instruments or CD music. Please note that the Tune function does not affect the Drum Kit or SFX Kit Voices and Audio Songs. To restore the default initial setting (440.0 Hz), touch and hold down the setting value for a while.

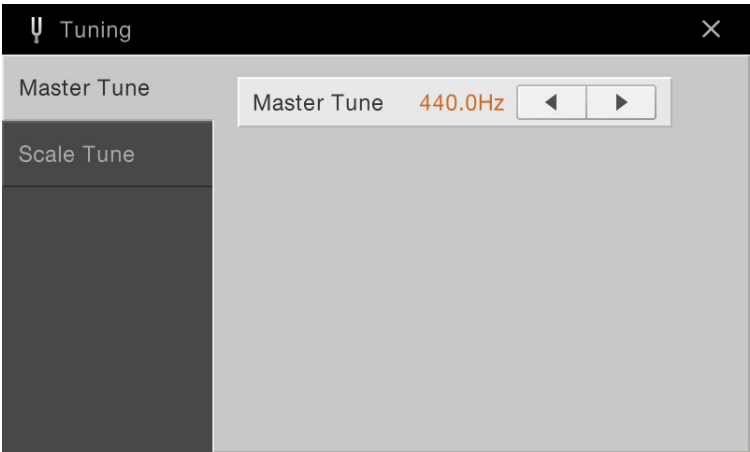

Scale Tune – Selecting or Creating a Temperament

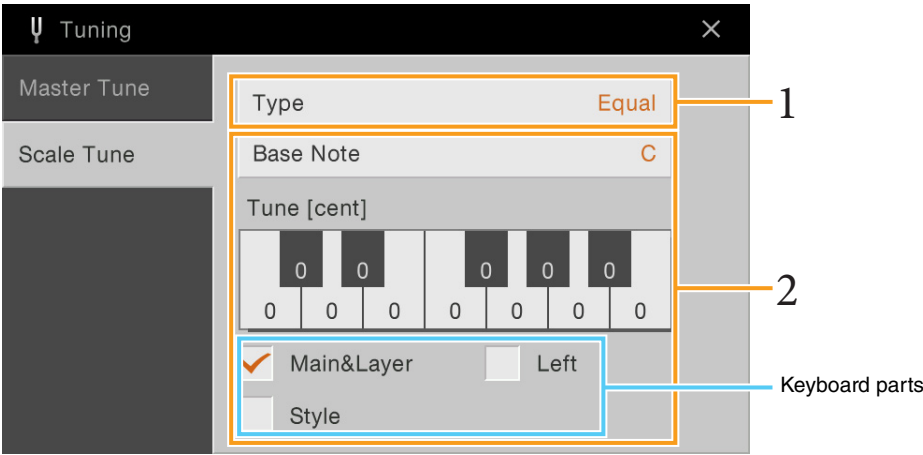

1 Select the desired Scale type (temperament).

You can select one of various scales for playing in custom tunings for specific historical periods or music genres.

Type	<ul style="list-style-type: none"> • Equal: The pitch range of each octave is divided equally into twelve parts, with each half-step evenly spaced in pitch. This is the most commonly used tuning in music today. • Pure Major, Pure Minor: These tunings preserve the pure mathematical intervals of each scale, especially for triad chords (root, third, fifth). You can hear this best in actual vocal harmonies — such as choirs and a cappella singing. • Pythagorean: This scale was devised by the famous Greek philosopher and is created from a series of perfect fifths, which are collapsed into a single octave. The 3rd in this tuning are slightly unstable, but the 4th and 5th are beautiful and suitable for some leads. • Mean-Tone: This scale was created as an improvement on the Pythagorean scale, by making the major third interval more “in tune.” It was especially popular from the 16th century to the 18th century. Handel, among others, used this scale. • Werckmeister, Kirnberger: This composite scale combines the Werckmeister and Kirnberger systems, which were themselves improvements on the mean-tone and Pythagorean scales. The main feature of this scale is that each key has its own unique character. The scale was used extensively during the time of Bach and Beethoven, and even now it is often used when performing period music on the harpsichord. • Arabic1, Arabic2: Use these tunings when playing Arabic music.
-------------	---

2 Change the following settings as necessary.

Base Note	Determines the base note for each scale. When the base note is changed, the pitch of the keyboard is transposed, yet maintains the original pitch relationship between the notes.
Tune [cent]	Select the desired note to be tuned and tune it in cents. If you edit this parameter, “(Edited)” is shown at the right of “Type” in step 1. NOTE In musical terms a “cent” is 1/100th of a semitone. (100 cents equal one semitone.)
(Parts)	Checkmark the part to which the Scale Tune setting is applied. NOTE If a VRM Voice is selected as the Main part, the resonance of all VRM Voices is set to the same scale type as that of the Main part. If a Voice other than a VRM Voice is selected as the Main part, the resonance of any other VRM Voices is set to “Equal.”

To store the Scale Tune settings:

If you want to store the Scale Tune settings, use the Registration Memory. Press the REGISTRATION MEMORY [MEMORY] button, then checkmark “Scale Tune” and press one of the REGISTRATION MEMORY [1] – [8] buttons to register the Scale Tune settings.



Setting the Touch Sensitivity of the Keyboard

You can adjust the touch response of the instrument (how the sound responds to the way you play the keys). This setting does not change the weight of the keyboard.

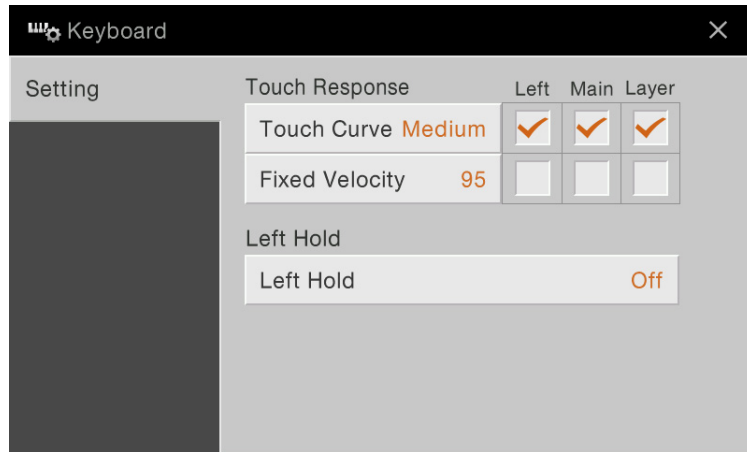

For information about this display, refer to the Owner's Manual.



Metronome Settings

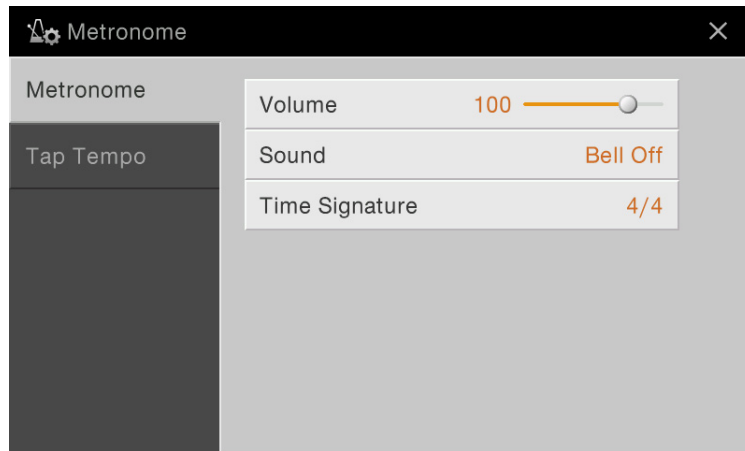

Metronome

Volume	Determines the level of the metronome sound.
Sound	<p>Determines which sound is used for the metronome.</p> <ul style="list-style-type: none"> • Bell Off: Conventional metronome sound, with no bell. • Bell On: Conventional metronome sound, with bell. • English Voice: Count in English • German Voice: Count in German • Japanese Voice: Count in Japanese • French Voice: Count in French • Spanish Voice: Count in Spanish
Time Signature	Determines the time signature of the metronome sound.

Tap Tempo

Volume	Adjusts the volume of the sound triggered when the [TAP TEMPO] button is pressed.
Sound	Selects the percussion instrument as sound triggered when the [TAP TEMPO] button is pressed.



MIDI Settings

In this section, you can make MIDI-related settings for the instrument. This instrument gives you a set of ten pre-programmed templates that let you instantly and easily reconfigure the instrument to match your particular MIDI application or external device. Also, you can edit the pre-programmed templates and save up to ten of your original templates.

NOTE No MIDI signals are received in the Piano Room.

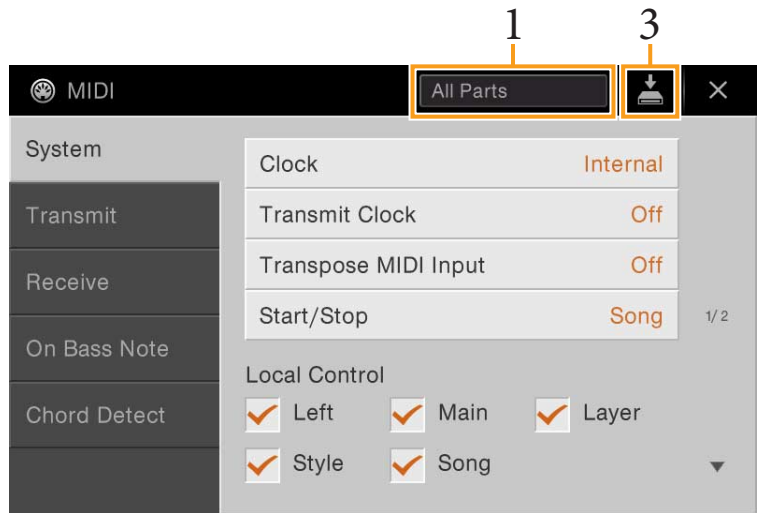

1 Touch the box (shown above), then select a pre-programmed MIDI template (below).

If you have already created an original MIDI template and saved it to User memory (in steps 2 and 3 below), you can also select that template from User memory.

2 If desired, edit the MIDI parameters based on the MIDI template selected in step 1 in the relevant setting display.

- **System:** Lets you set the MIDI System related parameters.....[page 91](#)
- **Transmit:** Lets you set the MIDI Transmission related parameters.....[page 92](#)
- **Receive:** Lets you set the MIDI Reception related parameters.....[page 93](#)
- **On Bass Note:** Lets you select the MIDI channels of which the MIDI data coming from the external MIDI device will be used for detecting the bass note for Style playback.....[page 94](#)
- **Chord Detect:** Lets you select the MIDI channels of which the MIDI data coming from the external MIDI device will be used for detecting the chord type for Style playback.....[page 95](#)

3 When you've finished editing in each display, touch  (Save) to save the MIDI settings as your original MIDI Template.

NOTE Your original MIDI templates can be saved as a single file to a USB flash drive. On the display called up via [Menu] → [Utility] → [Factory Reset/Backup] → page 2/2, touch [Backup] of "MIDI" to execute the Save operation ([page 99](#)).

■ Pre-programmed MIDI Templates

All Parts	Transmits all parts including the keyboard parts (Main, Layer and Left), with the exception of Song parts.
KBD & STYLE	Basically the same as "All Parts" with the exception of how keyboard parts are managed. The right-hand parts are handled as "Upper" instead of Main and Layer, and the left-hand part is handled as "Lower."

Master KBD (Master Keyboard)	In this setting, the instrument functions as a “master” keyboard, playing and controlling one or more connected tone generators or other devices (such as a computer/sequencer).
Song	With this setting, only the Song channels 1 – 16 are transmitted from this instrument via the corresponding channel numbers 1 – 16 respectively. This is used to play Song data with an external tone generator and to record Song data to an external sequencer.
Clock Ext (Clock External)	Playback or recording (Song, Style, etc.) synchronizes with an external MIDI clock instead of the instrument’s internal clock. This template should be used when you wish to set the tempo on the MIDI device connected to the instrument.
MIDI Accord1 (MIDI Accordion 1)	MIDI accordions allow you to transmit MIDI data and play connected tone generators from the keyboard and bass/chord buttons of the accordion. This template lets you control the keyboard performance and Style playback from a MIDI Accordion.
MIDI Accord2 (MIDI Accordion 2)	Basically the same as “MIDI Accord1” above, with the exception that the chord/bass notes you play with your left hand on a MIDI Accordion are recognized also as MIDI note events.
MIDI Pedal1	MIDI pedal units allow you play connected tone generators with your feet (especially convenient for playing single note bass parts). This template lets you play/control the chord root in Style playback with a MIDI pedal unit.
MIDI Pedal2	This template lets you play the bass part for Style playback by using a MIDI pedal unit.
MIDI OFF	No MIDI signals are sent or received.

System – MIDI System Related Settings

The explanations here apply when you call up “System” display in step 2 on [page 90](#).

Clock	<p>Determines whether the instrument is controlled by its own internal clock (“Internal”) or a MIDI clock (“MIDI,” “USB1,” “USB2,” and “Wireless LAN”) received from an external device. “Internal” is the normal Clock setting when the instrument is being used alone or as a master keyboard to control external devices. If you are using the instrument with an external sequencer, MIDI computer, or other MIDI device, and you want to synchronize it to that device, set this parameter to the appropriate setting: “MIDI,” “USB 1,” “USB 2,” or “Wireless LAN.” In this case, make sure that the external device is connected properly (e.g., to the instrument’s MIDI IN terminal), and that it is properly transmitting a MIDI clock signal. When this is set for control by an external device (“MIDI,” “USB1,” “USB2,” or “Wireless LAN”), the Tempo is indicated as “Ext.” in the Tempo display.</p> <p>NOTE If the Clock is set other than “Internal,” the Style, Song, Metronome and Tempo cannot be controlled by the buttons on this instrument.</p> <p>NOTE “Wireless LAN” is shown only when the USB Wireless LAN adaptor (which may not be included depending on your area) is connected to this instrument.</p>
Transmit Clock	Turns MIDI clock (F8) transmission on or off. When set to “Off,” no MIDI clock or Start/Stop data is transmitted even if a Song or Style is played back.
Transpose MIDI Input	Determines whether or not the instrument’s transpose setting is applied to the note events received from the external device via MIDI.
Start/Stop	Determines whether incoming FA (start) and FC (stop) messages affect Song or Style playback.

Local Control		Turns the Local Control for each part on or off. When Local Control is set to “On,” the keyboard of the instrument controls its own (local) internal tone generator, allowing the internal Voices to be played directly from the keyboard. If you set Local to “Off,” the keyboard and controllers are internally disconnected from the instrument’s tone generator section so that no sound is output when you play the keyboard or use the controllers. For example, this allows you to use an external MIDI sequencer to play the instrument’s internal Voices, and use the instrument keyboard to record notes to the external sequencer and/or play an external tone generator.
System Exclusive Message	Transmit	Determines whether MIDI System Exclusive messages are transmitted (On) or not (Off) from this instrument.
	Receive	Determines whether MIDI System Exclusive messages are recognized (On) or not (Off) by this instrument.
Chord System Exclusive Message	Transmit	Determines whether MIDI chord exclusive data (chord detect. root and type) are transmitted (On) or not (Off) from this instrument.
	Receive	Determines whether MIDI chord exclusive data (chord detect. root and type) are recognized (On) or not (Off) by this instrument.

Transmit – MIDI Transmit Channel Settings

The explanations here apply when you call up the “Transmit” display in step 2 on [page 90](#). This determines which MIDI channel is used for each part when MIDI data is transmitted from this instrument.

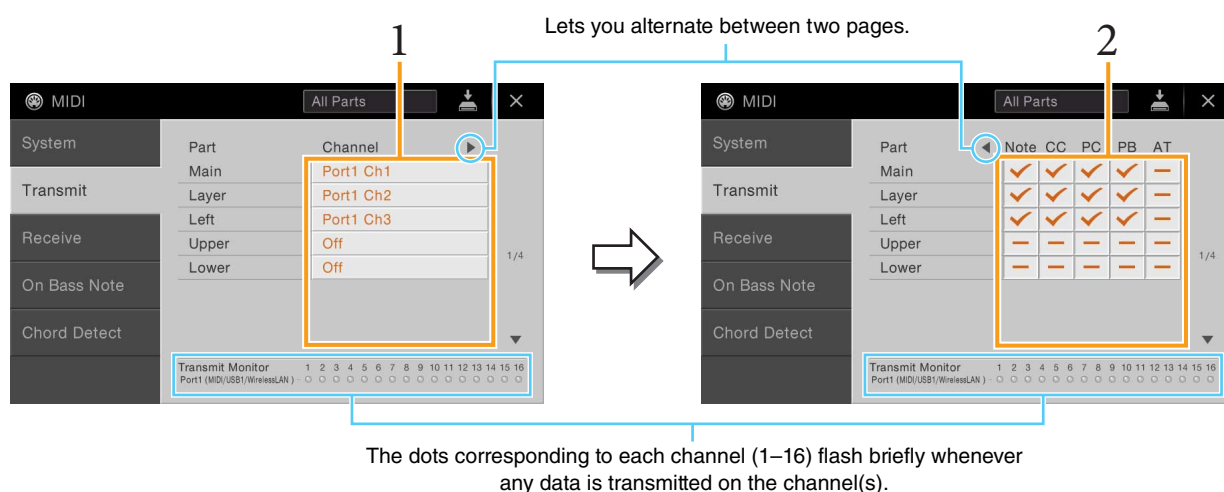

1 For each Part, select the MIDI Transmit Channel with which the MIDI data of the corresponding Part is to be transmitted.

With the exception of the two parts below, the configuration of the parts is the same as those already explained elsewhere in the Owner’s Manual.

- **Upper:** A keyboard part played on the right side of the keyboard from the Left Split Point.
- **Lower:** A keyboard part played on the left side of the keyboard from the Left Split Point. This is not affected by the on/off status of the [ACMP ON/OFF] button.

NOTE If the same transmit channel is assigned to several different parts, the transmitted MIDI messages are merged to a single channel — resulting in unexpected sounds and possible glitches in the connected MIDI device.

NOTE Protected Songs cannot be transmitted even if the proper Song channels 1 – 16 are set to be transmitted.

2 Touch [▶] to call up the other page then select which MIDI messages are to be transmitted for each Part.

The following MIDI messages can be set on the Transmit/Receive display.

- **Note (Note events)** page 69
- **CC (Control Change)**..... page 69
- **PC (Program Change)**..... page 69
- **PB (Pitch Bend)** page 69
- **AT (Aftertouch)** page 69

Receive – MIDI Receive Channel Settings

The explanations here apply when you call up the “Receive” display in step 2 on page 90. This determines which Part is used for each MIDI channel when the MIDI data is recognized by this instrument.

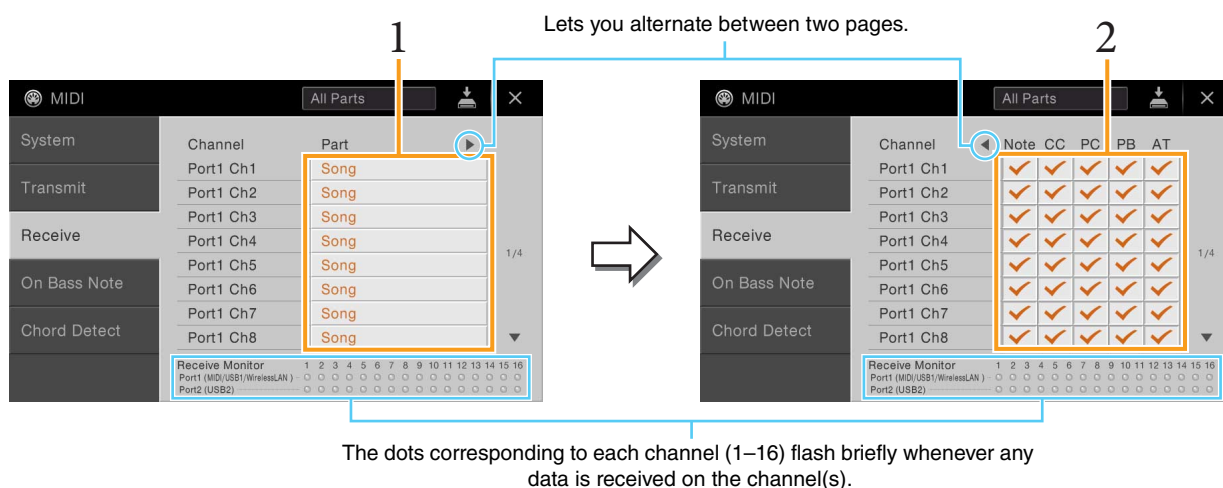

1 For each Channel, select the Part which is to handle the MIDI data of the corresponding channel received from the external MIDI device.

When connecting via USB, MIDI data of 32 channels (16 channels x 2 Ports) can be handled by this instrument. With the exception of the two parts below, the configuration of the parts is the same as those already explained elsewhere in the Owner’s Manual.

- **Keyboard:** The received note messages control the instrument’s keyboard performance.
- **Extra Part 1 – 5:** These five parts are specially reserved for receiving and playing MIDI data. Normally, these parts are not used by the instrument itself.

2 Touch [▶] to call up the other page then select which MIDI messages are to be received for each Channel.

MIDI transmission/reception via the USB terminal, Wireless LAN, and MIDI terminals

The relationship between the MIDI terminals, Wireless LAN and the [USB TO HOST] terminal which can be used for transmitting/receiving 32 channels (16 channels x 2 ports) of the MIDI messages is as follows:

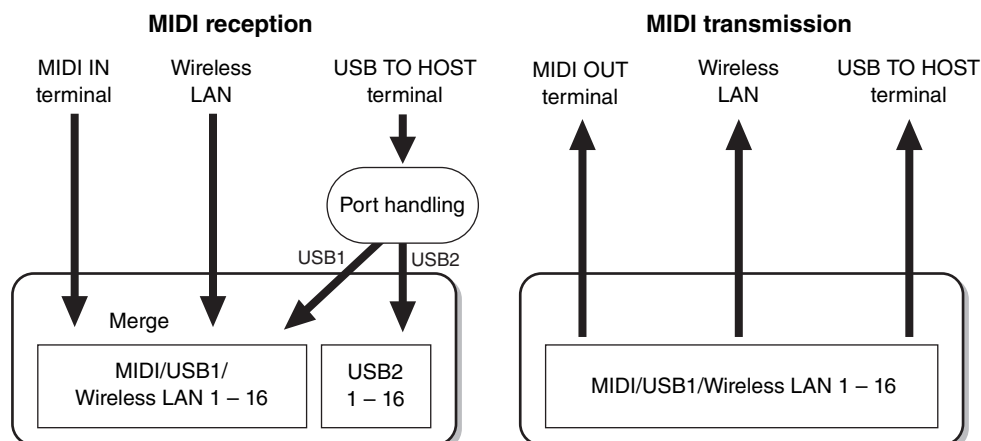

On Bass Note – Setting the Bass Note for Style Playback

The explanations here apply when you call up “On Bass Note” display in step 2 on [page 90](#). The settings here let you determine the bass note for Style playback, based on the note messages received via MIDI. The note on/off messages received at the channel(s) set to on are recognized as the bass notes of the chords for Style playback. The bass note will be detected regardless of the [ACMP ON/OFF] or Split Point settings. When several channels are simultaneously set to on, the bass note is detected from merged MIDI data received over the channels.

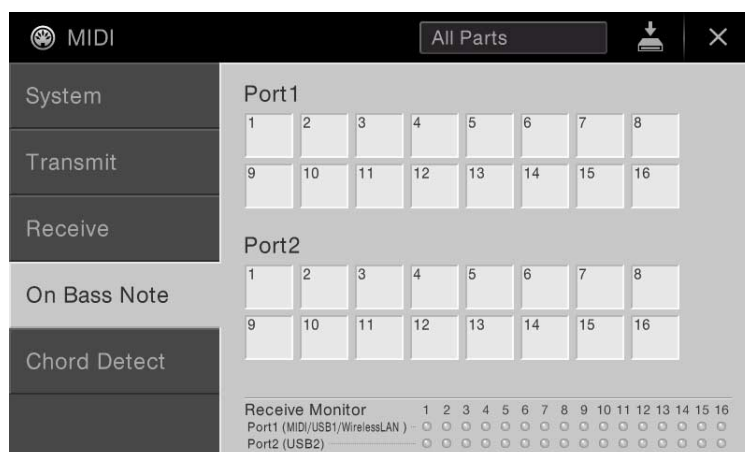

Touch the desired channel number to enter the checkmark. Touch the same location again to remove the checkmark.

Chord Detect – Setting the Chord Type for Style Playback

The explanations here apply when you call up “Chord Detect” display in step 2 on [page 90](#). The settings here let you determine the chord type for Style playback, based on the note messages received via MIDI. The note on/off messages received at the channel(s) set to on are recognized as the notes for detecting chords in Style playback. The chords to be detected depend on the fingering type. The chord types will be detected regardless of the [ACMP ON/OFF] or split point settings. When several channels are simultaneously set to on, the chord type is detected from merged MIDI data received over the channels.

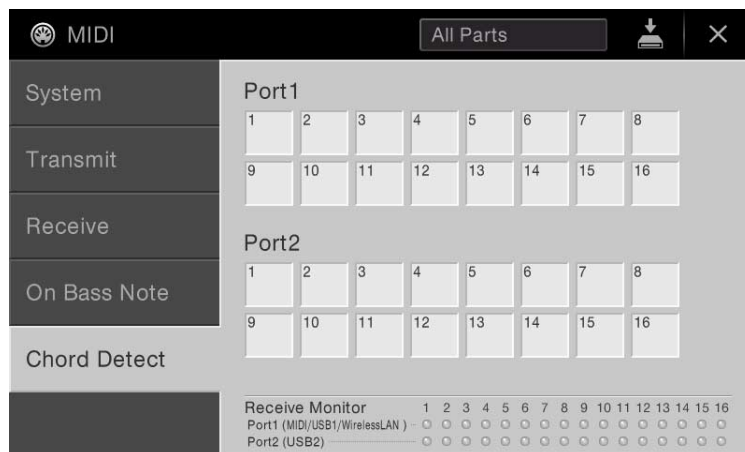

Touch the desired channel number to enter the checkmark. Touch the same location again to remove the checkmark.



Making Global Settings (Utility)

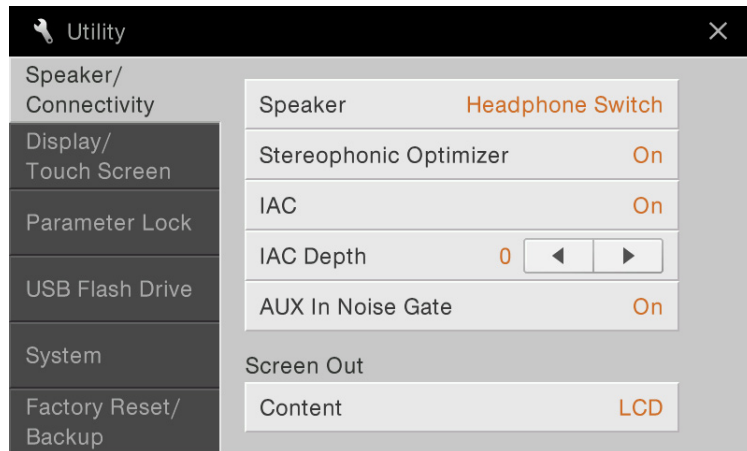

Speaker/Connectivity

Speaker	<p>Determines how the sound is output from the speaker of this instrument.</p> <ul style="list-style-type: none"> • Headphone Switch: Speaker sounds normally, but is cut off when headphones are inserted to the [PHONES] jack. • On: Speaker sound is always on. • Off: Speaker sound is off. You can only hear the instrument sound via the headphones or an external device connected to the AUX OUT jacks.
Stereophonic Optimizer	<p>Turns the Stereophonic Optimizer on or off.</p> <ul style="list-style-type: none"> • On: This function is effective on the VRM Voices sounded from the headphone(s) connected to the [PHONE] jack(s). <p>NOTE If the "Speaker" setting above is "On" and headphone(s) are connected to the [PHONE] jack(s), this function is effective on the VRM Voices from the headphone(s) as well as from the speakers of the instrument.</p> <p>NOTE If the headphone(s) are connected to the [PHONE] jack(s) and external audio devices are connected to the AUX OUT[L/L+R]/[R] jacks, this function is effective on the VRM Voices from the headphone(s) as well as from the audio devices.</p> <ul style="list-style-type: none"> • Off: The Stereophonic Optimizer effect is not applied.
IAC (Intelligent Acoustic Control)	<p>Turns on or off the IAC (Intelligent Acoustic Control). With this function, the sound quality of this instrument is automatically adjusted and controlled according to the overall volume. Even when the volume is low, this lets you hear both low sounds and high sounds clearly.</p>
IAC Depth	<p>Adjusts the IAC depth.</p>
AUX In Noise Gate	<p>Turns on or off the Noise Gate which minimizes noise of the sound input via the [AUX IN] jack.</p>
Screen Out	<p>Content</p> <p>Determines the contents of the Video Out signal.</p> <ul style="list-style-type: none"> • Lyrics/Text: Only the lyrics of the Song or text files (whichever you used last time) are output, regardless of the display that is called up on the instrument. • LCD: The currently selected display is output.

Display/Touch Screen

Display	Home Theme	Touch and change the theme (background) of the Home display. The available settings are Piano/White/Black.
	Brightness	Touch [◀]/[▶] to adjust the brightness of the display.
	Time Stamp	Determines whether the time stamp of a file is shown on the User tab of the File Selection display or not. NOTE When the instrument is connected to a network via the USB wireless LAN adaptor*, the current time is taken from the network and displayed. For details, refer to page 103 . * A USB wireless LAN adaptor may not be included depending on your area.
	Pop-up Display Time	Determines the time that elapses before the pop-up windows close. Pop-up windows appear when you press buttons TEMPO [-]/[+], TRANSPOSE [-]/[+], SONG CONTROL [◀◀](REW)/[▶▶](FF), or REGISTRATION BANK [-]/[+]. When “Hold” is selected here, the pop-up window is shown until you touch [X].
	Transition Effect	Turns on or off the Transition Effect which is applied when the display is changed.
	Voice Area	Determines which keyboard parts are shown in the Voice area of the Home display. When “Show Active Parts Only” is selected, only the active keyboard parts are shown. When “Show All Parts” is selected, all the keyboard parts are shown.
Touch Screen	Sound	Determines whether or not touching the display will trigger the click sound.
	Calibration	Lets you calibrate the display when it does not respond properly to your touching (Normally, you do not need this operation, since it is calibrated by factory default). Touch here to call up the Calibration display, then touch the center of the plus marks (+) in order.

Parameter Lock

This function is used to “lock” specific parameters (effect, split point, etc.) to make them selectable only via the panel control — in other words, instead of being changed via Registration Memory, One Touch Setting, Music Finder, or Song and sequence data.

To lock the desired parameter, touch the corresponding box to enter the checkmark. To unlock the parameter, touch the box again.

USB Flash Drive

This lets you execute the Format operation or check the memory capacity (approximate value) of the USB flash drive connected to this instrument. For details on instructions, refer to the Owner’s Manual.

System

Page 1/2

For information about this display, refer to “Making the Basic Settings” in the Owner’s Manual.

Page 2/2

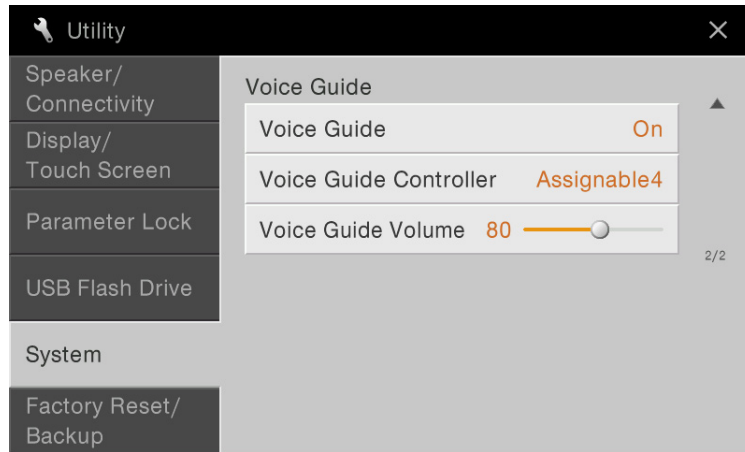

Voice Guide	Determines whether or not Voice Guide is used (On/Off), when USB flash drive containing the Voice Guide (audio) file is properly connected to this instrument. This setting can also be changed by pressing and holding the [DEMO] button for longer than three seconds.
Voice Guide Controller	By holding the controller set here and then pressing the panel button or touching the item on the display, you can hear the corresponding name (with no execution of the function).
Voice Guide Volume	Adjusts the volume of Voice Guide.

To use Voice Guide, you need to download the Voice Guide (audio) file from the Yamaha website, and save it to USB flash drive, which you then connect to this instrument. For information on using Voice Guide, refer to the Voice Guide Tutorial Manual (simple text file).

The Voice Guide (audio) file and the Voice Guide Tutorial Manual are available via the following URL:

<http://download.yamaha.com/>

Factory Reset/Backup

Factory Reset — Restoring the Factory Programmed Settings

On page 1/2, checkmark the boxes of the desired parameters then touch [Factory Reset] to initialize the settings of the parameters which are checkmarked.

System	Restores the System Setup parameters to the original factory settings. Refer to “Parameter Chart” in the Data List for details about which parameters belong to the System Setup.
MIDI	Restores the MIDI settings including the MIDI templates saved in the internal User memory to the original factory status.
User Effect	Restores the User Effect settings including the following data to the original factory settings. <ul style="list-style-type: none"> • User Effect types (page 14) • User Master EQ types (page 12) • User Master Compressor types (page 16) • User Vocal Harmony types (page 31) • User Microphone Settings (page 26)
Registration	Turns off all the REGISTRATION MEMORY [1] – [8] lamps, indicating that no Registration Memory Bank is selected although all the Bank files are maintained. In this status, you can create Registration Memory setups from the current panel settings.
Music Finder	Restores the Music Finder data (all records) to the original factory settings.
Files&Folders	Deletes all files and folders saved in the internal User memory and resets the User memory to the default status. This also deletes the registration to the Favorite (★) tab on the Voice or Style Selection display.

Backup/Restore – Saving and Recalling Your Original Settings as a Single File –

For the items below, you can save your original settings to the internal User memory or USB flash drive as a single file for future recall.

1 Make all desired settings on the instrument, then call up page 2/2 of the “Factory Reset/Backup” display.

2 Touch [Backup] of the desired item.

If you want to save the backup file to the USB flash drive, make sure to connect the USB flash drive to the instrument. When you select “All,” the backup file can only be saved to the USB flash drive.

All	All settings and data in the User memory of this instrument (except for protected Song) are handled as a single bulk file named “CVP-709.bup” or “CVP-705.bup.” Because just by touching [Backup] of “All” will save the file to the root directory of the USB flash drive, step 3 is not necessary.
System	Parameters set on the various displays such as “Utility” are handled as a single System Setup file. Refer to “Parameter Chart” in the Data List for details on which parameters belong to System Setup.
MIDI	The MIDI settings including the MIDI templates on the internal User memory are handled as a single MIDI Setup file.

User Effect	<p>The User Effect settings including the following data can be managed as a single file.</p> <ul style="list-style-type: none"> • User Effect types (page 14) • User Master EQ types (page 12) • User Master Compressor types (page 16) • User Vocal Harmony types (page 31) • User Microphone Settings (page 26)
Music Finder	All the preset and created Records of the Music Finder are handled as a single file.

3 Select the desired destination to save the Backup file, then touch [Backup here].

Assign the name if necessary, then touch [OK] to save the file.

To call up the Backup file:

Touch [Restore] of the desired item, then select the desired file.

You can restore the factory programmed status by selecting the Backup file in the “Preset” tab.

NOTICE

- Files including Protected Songs in the User memory of the instrument are replaced by restoring the backup file. Move or copy the files in the User memory of the instrument to USB flash drive before restoring.
- Completing the backup/restore operation may take a few minutes. Do not turn off the power during backup or restoring. If you turn off the power during backup or restoring, data may be lost or damaged.



Wireless LAN Settings

This icon is shown only when the USB Wireless LAN adaptor (which may not be included depending on your area) is connected to the [USB TO DEVICE] terminal. Make sure the adaptor is connected before executing any operations. By touching this icon and making wireless LAN settings, you can connect the CVP-709/CVP-705 with an iPhone/iPad via a wireless network. For general operating instructions, refer to the iPhone/iPad Connection Manual on the website. This section covers only operations that are specific to the CVP-709/CVP-705. For information about the compatible smart devices and application tools, access the following page: <http://www.yamaha.com/kbdapps/>

Infrastructure Mode

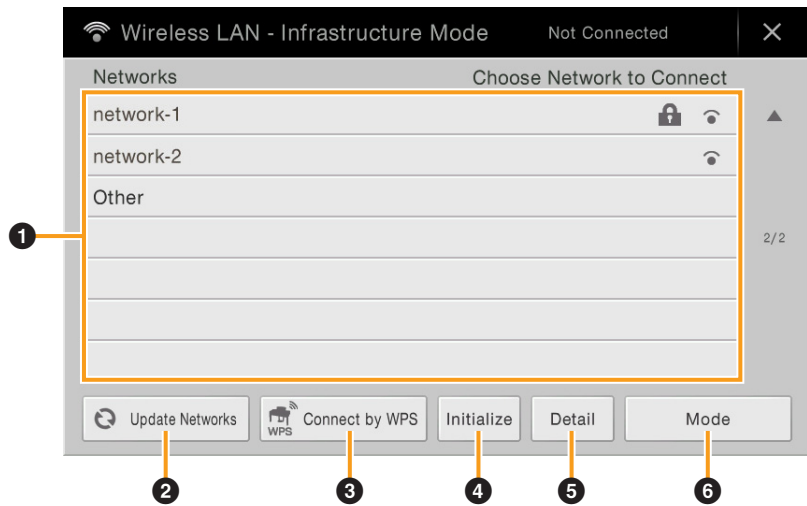

❶	Networks	<p>Connecting to a network listed on the display: From the Networks listed on the display, select the desired one. For a network having a lock icon (🔒), you need to enter the password and touch [Connect]; for a network without a lock icon, you can connect the network only by selecting it.</p> <p>Manual Setup: Touch [Other] displayed at the very end of the list to call up the Manual Setup display, for making SSID, security, and password settings. After entering them, touch [Connect] on the Manual Setup display to connect to the network.</p>
❷	Update Networks	Updates the Network List on the display.
❸	Connect by WPS	<p>Connects this instrument to the network via WPS. After touching [Start WPS] in the window appeared by touching here, press the WPS button of the desired wireless LAN access point within two minutes.</p> <p>NOTE Make sure that your access point supports WPS. About the confirmation and changes in the access point settings, refer to the manual of the access point.</p>
❹	Initialize	Initializes the connection setup to the default factory status.
❺	Detail	Lets you set detailed parameters such as the static IP address. After setting, touch [OK].
❻	Mode	Switches to the Adhoc Mode.

Adhoc Mode

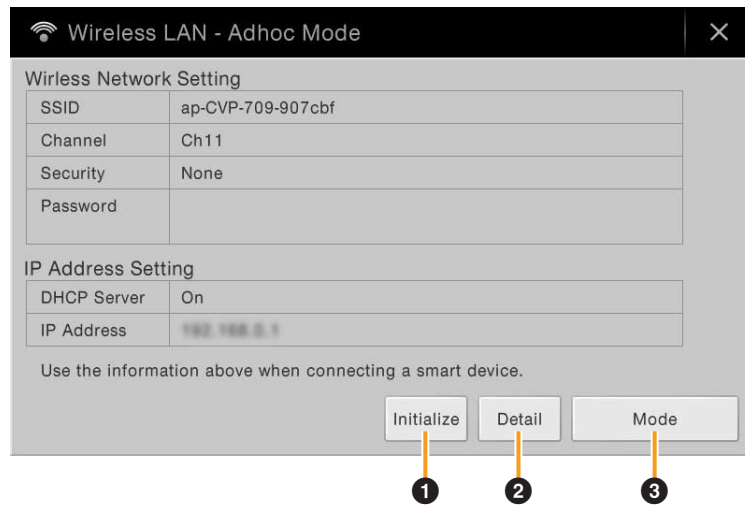

❶	Initialize	Initializes the connection setup to the default factory status.
❷	Detail	Sets the detailed parameters. <ul style="list-style-type: none"> • 1/3 page: Sets the SSID, security, password, and channel. • 2/3 page: Sets the IP address and other related parameters. • 3/3 page: Enters the Host name or shows MAC address, etc.
❸	Mode	Switches to the Infrastructure Mode.

When the connection is done successfully, “Connected” is shown at the top of the display, and one of the icons shown below appears indicating the signal strength.





Making the Time Settings

This icon is shown only when the USB Wireless LAN adaptor (which may not be included depending on your area) is connected to the [USB TO DEVICE] terminal. Make sure the adaptor is connected before executing any operations.

For details on the connections, refer to the “iPhone/iPad Connection Manual” on the website. Make sure to connect by Infrastructure Mode. When the instrument is connected to a network and the current time is retrieved from the network successfully, the current time is displayed above the icon.

You can make the time settings by touching this icon.

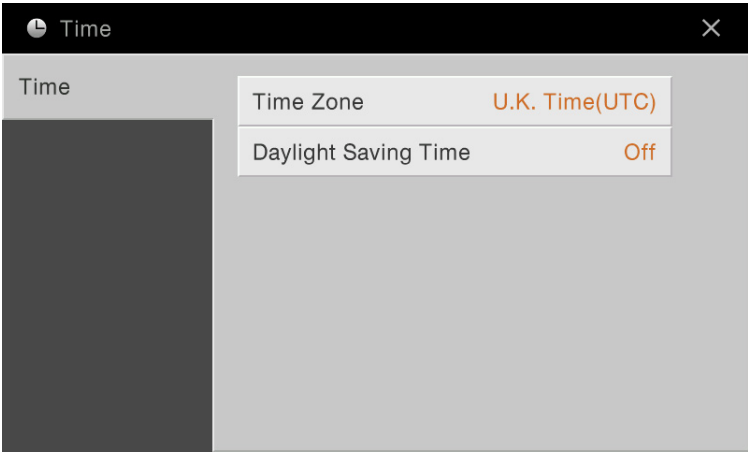

Time Zone	Touch to select the Time Zone.
Daylight Saving Time	Touch to turn daylight-saving time on or off.





NOTE When the instrument cannot retrieve the current time from the network, the time displayed will not be correct.

Chapter 2

Other Functions and Settings

This chapter explains about the detailed functions and usages called up by displays except the Menu display.

Adjusting the Accompaniment Volume or Turning Each Accompaniment Part On/Off in the Piano Room

- 1 Press the  [PIANO ROOM] button to call up the Piano Room display.
- 2 Touch  at the upper right of the display.
Session players appear in the display. Session players can be shown or hidden by touching  or .

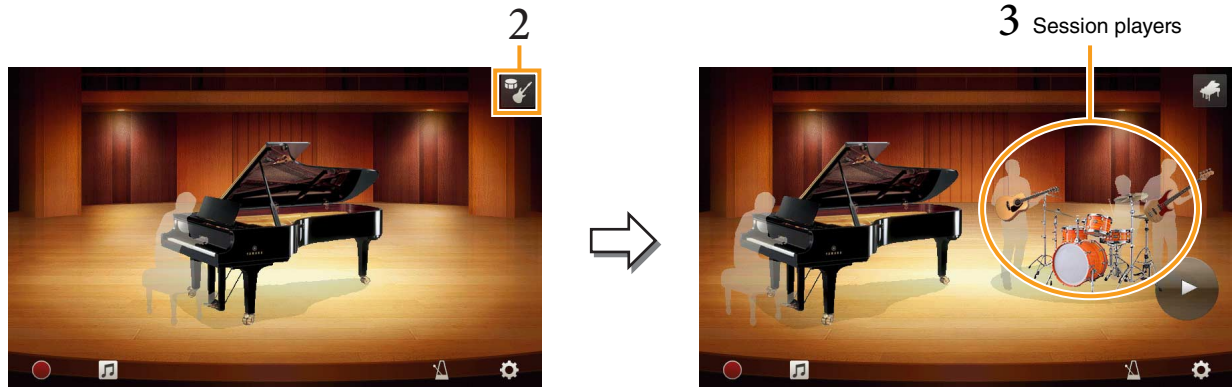

- 3 Touch the picture of the session players to call up the accompaniment list.



- 4 Touch  (Settings) to call up the display for adjusting the volume of the accompaniment or for turning each part of the accompaniment on or off.

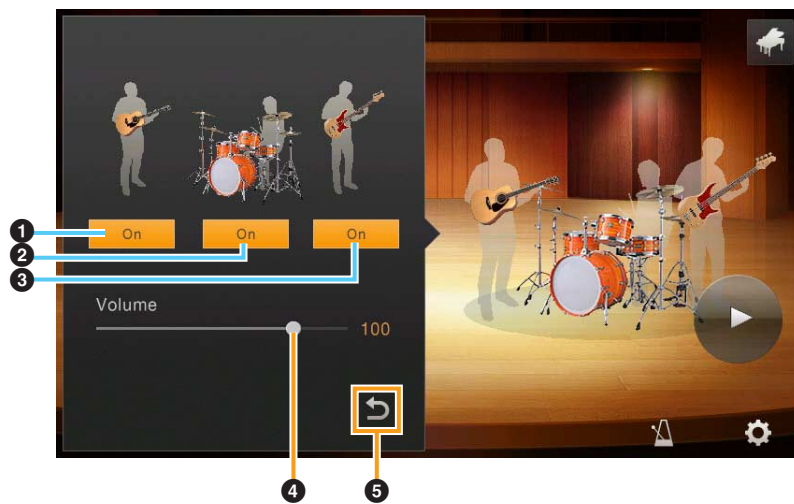

❶	Turns all parts, except those of rhythm and bass, on or off.
❷	Turns the rhythm parts and bass parts on or off.
❸	Turns the bass part on or off.
❹	Move the slider to adjust the volume of the accompaniment.
❺	Touch here to go back to the accompaniment list.

Displaying the Instruments Assigned to the Keyboard (Drum Kit Tutor)

You can play various drums and percussion instruments or SFX (sound effects) sounds on the keyboard by using Drum Voices or SFX Voices. When an icon of Drum Kit Tutor appears in the Voice area of the Home display or below the Voice Selection display, you can call up the key assignment by touching the icon.

1 Touch (Drum Kit Tutor) on the Voice area of the Home display or below the Voice Selection display.

The Drum Kit Tutor display appears.

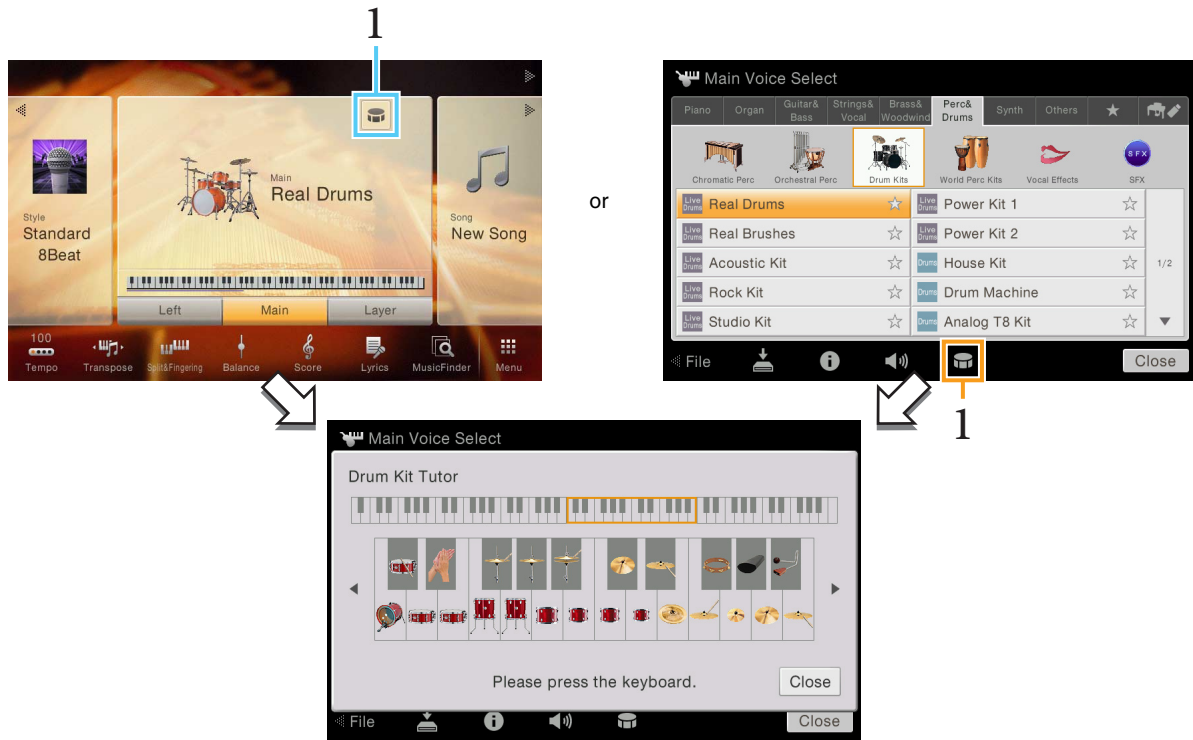

2 Press the desired key to check the key assignment.

The illustration and the name of the instrument assigned to the key appear on the Drum Kit Tutor display. Touch [◀]/[▶] to shift the illustration and instrument names by octaves (or press the desired key outside the displayed range).

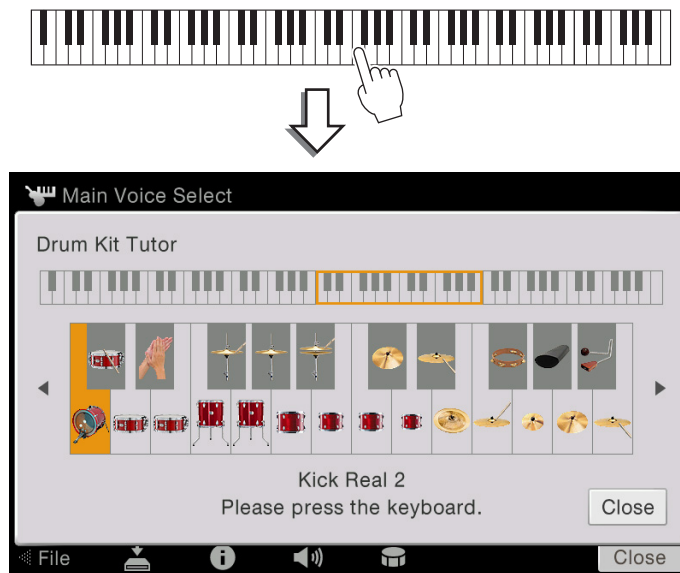

Recording the Right- and Left-hand Parts Separately (MIDI Recording)

The Multi Channel Recording method lets you record data to each channel independently, one by one, up to 16. Here, you will learn how to create a complete, two-handed piano piece by recording the right-hand part to channel 1, and then recording the left-hand part to channel 2 while listening to the already recorded data. Before starting recording, make the following panel settings:

- Turn the Main part on, and then select the desired piano voice as the Main part.
- Turn the Left and Layer parts off.

Recording the Right-hand Part

- 1** On the Home display, touch [▶] at the upper right to expand the Song area, then touch [●] (Rec) to call up the Song Recording window.

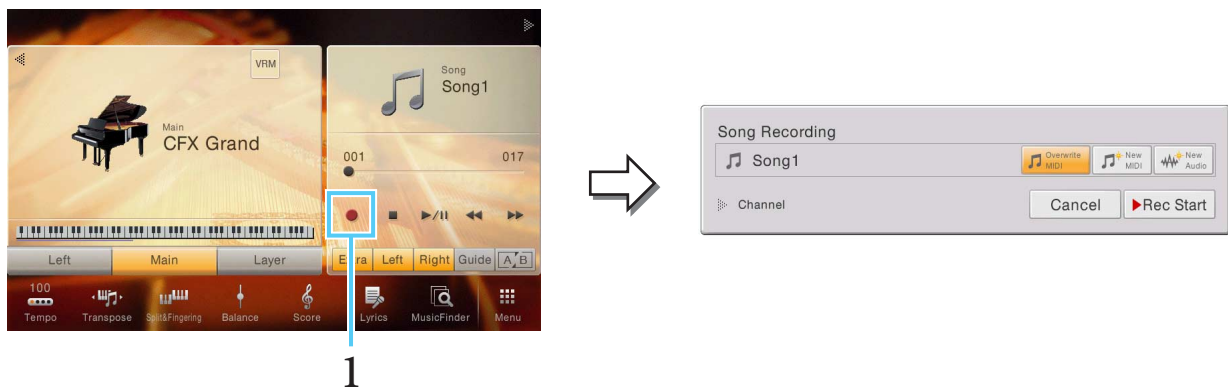

NOTE The contents of the Song Recording window differ depending on the panel settings.

NOTE Here and in the later steps, the operation in the Song area of the Home display can be controlled by the SONG CONTROL buttons.

- 2** Touch [New MIDI].



- 3** Touch [▶] at the left of “Channel” to expand the Channel area.

- 4** Specify the target channel and part for recording.

4-1 From the display, set the Main part to [Rec], and set all other parts to [Off]. You can conveniently use [Keyboard All] and [Style All] to turn multiple parts on/off.

4-2 Touch the channel number under the Main part you set to [Rec] in step 4-1. In the setting display that appears, specify channel 1 for recording. If not changed, the Main part will automatically be recorded to channel 1.

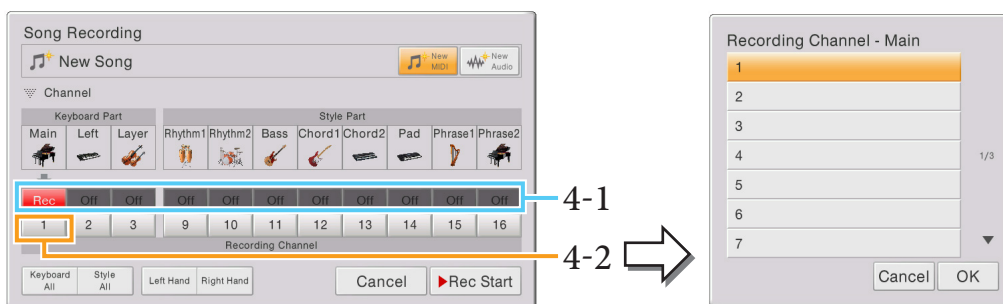

NOTE If you want to cancel recording, touch [Cancel] in the display or press the SONG CONTROL [REC] button before going on to step 5.

5 Play the keyboard with your right hand.

Recording begins automatically as soon as you play a note on the keyboard.

You can also start recording by touching [Rec Start] or pressing the SONG CONTROL [PLAY/PAUSE] button.



6 After you finish your performance, touch [■] (Stop) on the Home display to stop recording.



7 To hear the recorded performance, touch [▶/||] (Play/Pause).

This finishes recording of the right-hand part to channel 1, and lets you record the left-hand part to channel 2 (below).

Recording the Left-hand Part

8 Touch [●] (Rec) to call up the Song Recording window.

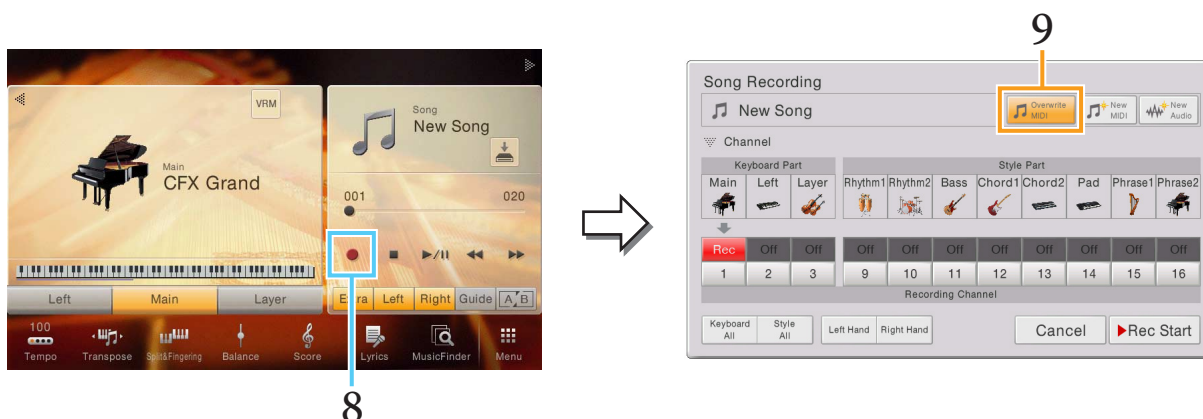

9 Confirm that [Overwrite MIDI] is selected.

10 Specify the target channel and part for recording.

10-1 From the display, set the Main part to [Rec], and set all other parts to [Off].

10-2 Touch the channel number under the Main part you set to [Rec] in step 10-1. In the setting display that appears, specify channel 2 for recording.

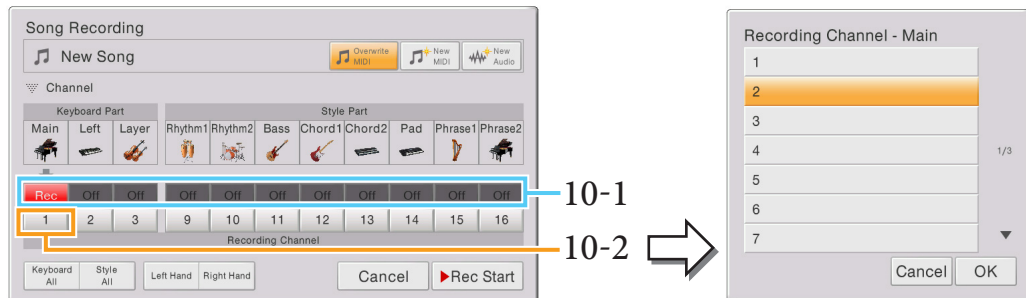

NOTICE

Previously recorded data will be overwritten if you set channels which have recorded data to [Rec].

NOTE If you want to cancel recording, touch [Cancel] in the display or press the SONG CONTROL [REC] button before going on to step 11.

11 Play the keyboard with your left hand.

Recording begins automatically as soon as you play a note on the keyboard. You can also start recording by touching [Rec Start] or pressing the SONG CONTROL [PLAY/PAUSE] button. You can play the keyboard while listening to the already recorded right-hand part.

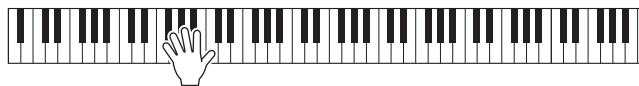

12 After you finish your performance, touch [■] (Stop) on the Home display to stop recording.

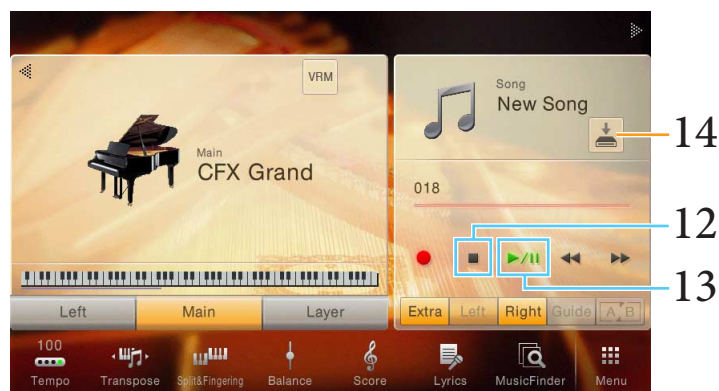

13 To hear the recorded performance, touch [▶/||] (Play/Pause).

This finishes recording of the right- and left-hand parts. Now you can save the recorded performance as a file (below).

Saving the Recorded Performance

14 On the Home display, touch (Save) shown in the Song area.

The Song Selection display appears for selecting a destination to save the recorded Song.

NOTICE

The recorded MIDI Song will be lost if you change to another Song or you turn the power off without executing the Save operation.

15 Select the location to which you want to save the file.

To show the next higher level folder, touch  (Above).

You can create a new folder by touching  (New Folder).

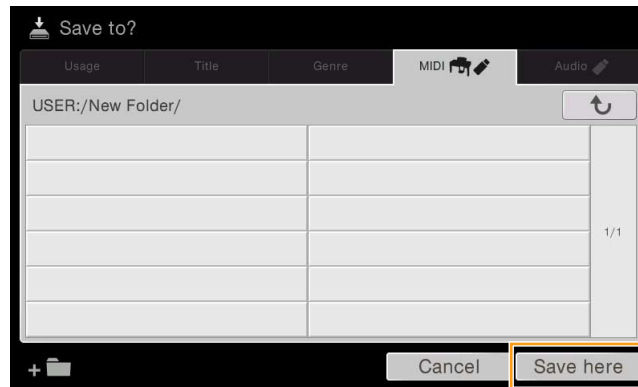

16

16 Touch [Save here] to call up the Character Entry window.

NOTE To cancel this operation, touch [Cancel].

17 Enter the file name.

Even if you skip this step, you can rename the file at any time after saving.

18 Touch [OK] in the Character Entry window to actually save the file.

The saved file will be automatically located at the appropriate position among the files in alphabetical order.

Recording Style Playback First, Then Melodies

The Multi Channel Recording method lets you create a song by recording a style first and then a melody on top of it. Here, you will learn how to record a style to channels 9 – 16 first, and then record a melody to channel 1 while listening to the already recorded style. The instructions hereafter assume the following panel settings as an example. Before starting recording, make the following panel settings:

- Turn the Main part on, and then select the desired voice of the Main part.
- Turn the Left and Layer parts off.
- Select the desired style.
- Set the Fingering Type ([Menu] → [Split&Fingering]) to “Multi Finger” (default setting).
- Make sure that the STYLE CONTROL [ACMP ON/OFF] button is turned on.

Recording a Style Performance

- 1 On the Home display, touch [▶] at the upper right to expand the Song area, then touch [●] (Rec) to call up the Song Recording window.**

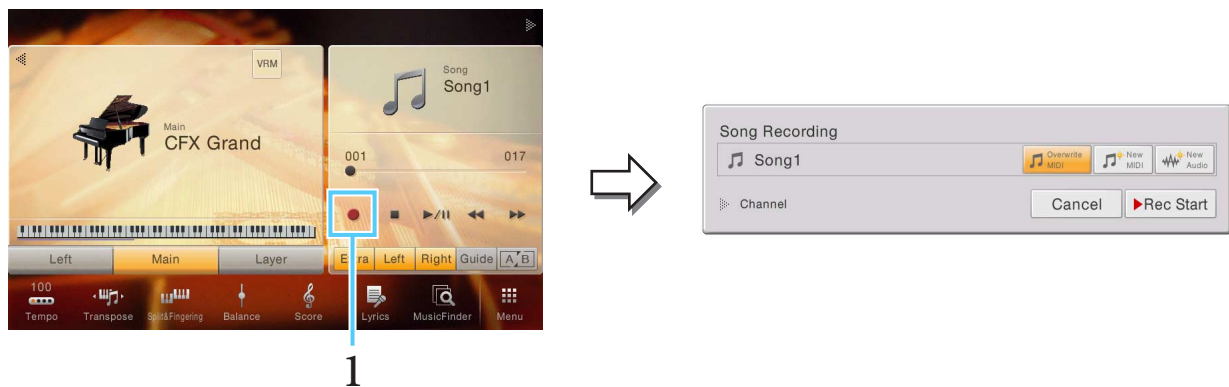

NOTE The contents of the Song Recording window differ depending on the panel settings.

NOTE Here and in the later steps, the operation in the Song area of the Home display can be controlled by the SONG CONTROL buttons.

- 2 Touch [New MIDI].**



- 3 Touch [▶] at the left of “Channel” to expand the Channel area.**

- 4 Specify the target channel and part for recording.**

4-1 From the display, set all of the Style Parts to record to [Rec], and set all other parts to [Off]. You can conveniently use [Keyboard All] and [Style All] to turn multiple parts on/off.

4-2 Touch the channel number under the Style parts you set to [Rec] in step 4-1. In the setting display that appears, specify the desired channels (9 – 16) for recording. If not changed, the Style parts will automatically be recorded to channels 9 – 16.

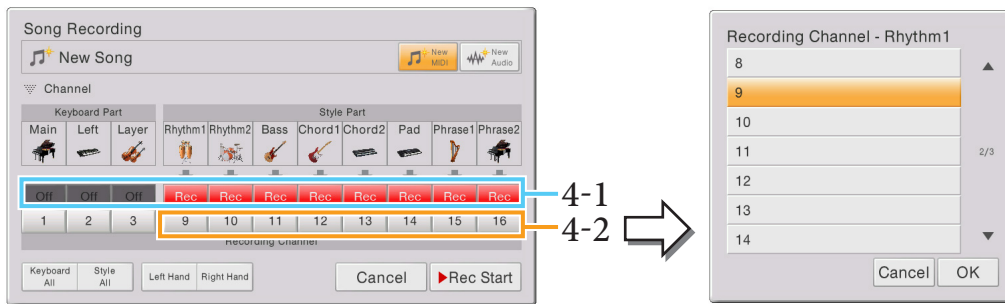

NOTE If you want to cancel recording, touch [Cancel] in the display or press the SONG CONTROL [REC] button before going on to step 6.

5 Press STYLE CONTROL [SYNC START] button and then play the Style by specifying the chord in the Chord Section.

Recording begins automatically as soon as you play the Style. You can also start recording by touching [Rec Start] or pressing the SONG CONTROL [PLAY/PAUSE] button. Perform as desired, playing the Style by changing chords and/or sections.

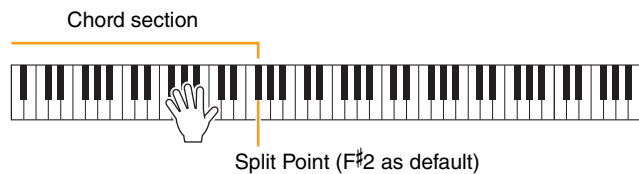

NOTE (CVP-709 only) The audio part of the Audio Style cannot be recorded by MIDI recording.

6 After you finish your performance, touch [■] (Stop) on the Home display to stop recording.

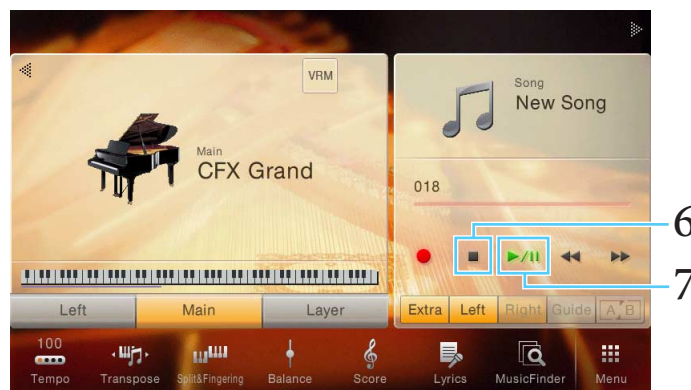

7 To hear the recorded performance, touch [▶/||] (Play/Pause).

This finishes recording of the Style. Now, let's record a melody to channel 1 (below).

Recording a Melody

8 Touch [●] (Rec) to call up the Song Recording window.

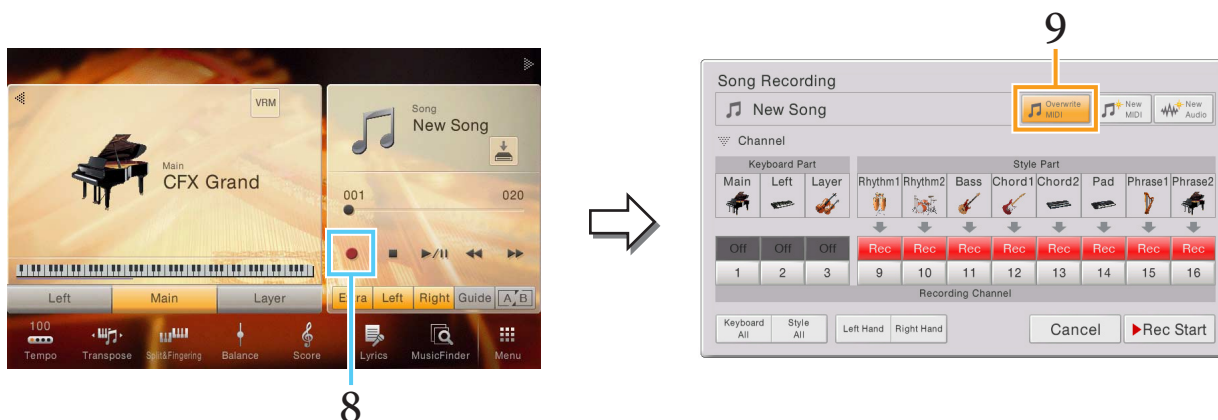

9 Confirm that [Overwrite MIDI] is selected.

10 Specify the target channel and part for recording.

10-1 From the display, set the Main part to [Rec], and set all other parts to [Off].

10-2 Touch the channel number under the Main part you set to [Rec] in step 10-1. In the setting display that appears, specify channel 1 for recording. If not changed, the Main part will automatically be recorded to channel 1 by default.

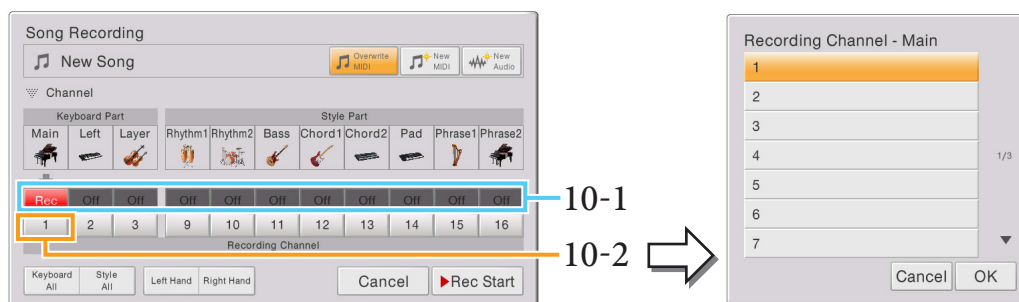

NOTICE

Previously recorded data will be overwritten if you set channels which have recorded data to [Rec].

NOTE If you want to cancel recording, touch [Cancel] in the display or press the SONG CONTROL [REC] button before going on to step 11.

11 Play a melody.

Recording begins automatically as soon as you play a note on the keyboard. You can also start recording by touching [Rec Start] or pressing the SONG CONTROL [PLAY/PAUSE] button. You can play a melody while listening to the already recorded Style performance.



12 After you finish your performance, touch [■] (Stop) on the Home display to stop recording.



13 To hear the recorded performance, touch [▶/||] (Play/Pause).

This finishes recording of the Style and the melody. Now, let's save the recorded performance as a file (below).

Saving the Recorded Performance

Save the recorded data as a file by following the instructions on [page 111](#), steps 14 – 18.

Index

Numerics

3 Band EQ 25

A

Accompaniment 105
 Adhoc Mode 102
 Amplitude 45
 Any Key 81
 Articulation 39
 Assembly 54
 Assignable 41
 Attack 44
 Attenuator 26
 Audio File Format 85
 Audio Part 48
 Audio Rec Format 85
 Audio Style 48, 80

B

Backup 99
 Backup file 100
 Balance 9, 10
 Bar Clear 56
 Bar Copy 56
 Bass Hold 40
 Beat Converter 55
 Block Diagram 17
 Brightness 10, 44
 Bypass 59

C

Channel Edit 55, 71
 Chord 19
 Chord Detect 83, 95
 Chord Detection Area 7
 Chord Source 28
 Chord Tutor 8
 Chordal 28
 Chorus 14
 Clock 63, 66, 70, 91
 Color 19
 Compressor 16, 25
 Cutoff frequency 44

D

Decay 44
 Display 97
 Dorian 59
 Drum Kit Tutor 107

Drums 76
 Dynamics 56
 Dynamics Control 78

E

Echo 24
 Effect 12, 45
 Effect Variation 39, 45
 EG (Envelope Generator) 44
 EQ (Equalizer) 11
 Equalizer 11
 Euro 46
 Event Filter 70
 Event List 63, 66, 69
 Expand 69

F

Factory Reset 99
 Fade In/Out 40
 Filter 10, 44
 Fingering Type 7
 Follow Lights 81
 Footage 46

G

Gain 16
 Genre 33
 Glide 39
 GM Voice 77
 Groove 55
 Guide 18, 81
 Guitar 58

H

Harmonic Cont. 44
 Harmonic Content 10, 44
 Harmonic Minor 59
 Harmony Assign 30
 Harmony note 29
 Harmony Type 23
 High Key 60

I

IAC (Intelligent Acoustic Control) 96
 Infrastructure Mode 101
 Insertion Effect 12, 13, 45

J

Jump 82

K

Karao-Key 81
 Key Off Sampling 74
 Key Signature 19
 Keyboard Harmony 23
 Keyword 33

L

Lead note 29
 Left Hold On/Off 41
 LFO Amplitude 45
 LFO Filter 45
 LFO Pitch 45
 Local Control 92
 Loop Recording 51
 Lyrics 19, 20

M

Manual Bass 7
 Manual Setup 101
 Master Compressor 16
 Master EQ 11
 Master Tune 86
 MegaVoice 76, 77
 Melodic Minor 59
 Metronome 89
 Microphone 25
 MIDI 90
 MIDI Accordion 91
 MIDI Pedal 91
 MIDI Receive Channel 93
 MIDI reception 94
 MIDI Template 90
 MIDI transmission 94
 MIDI Transmit Channel 92
 Mixer 10
 Modulation 39, 44, 45
 Mono 41, 43
 MP3 85
 Multi Assign 24
 Music Finder 32
 Music Notation 18

N

Natural Minor 59
 Network 101
 Noise Gate 25
 Note 19
 Note Limit 60

Note Name	19	RTR (Retrigger Rule)	60	Tuning Curve	74
NTR (Note Transposition Rule) ...	58				
NTT (Note Transposition Table) ..	59				
O		S		U	
Octave	73	Scale Tune	86	User Effect	99, 100
On Bass Note	94	Scale type	87	Utility	96
Organ Flutes	46, 76	Score	18		
Organ Type	46	Scrub	82	V	
Original Beat	55	SFF Edit	57	Variation Effect	12, 13
OTS Link Timing	79	SFX	76	Vibe Rotor	40
Overdub Recording	51	Sine	46	Vibrato	44
		Soft	39	Vintage	46
P		Song	81	Vocal Harmony	27
Pan	15	Song Creator	61	Vocoder	28
Parameter Lock	97	Song Position	63, 66, 70	Vocoder-Mono	28
Part EQ	11	Sostenuto	39	Voice	73
Pattern Length	50	Source Pattern	48	Voice Characteristics	75
Pedal	38	Source Root/Chord	58	Voice Edit	42, 46
Performance Assistant	83	Speaker	96	Voice Guide	98
Phrase Mark Repeat	82	Split Point	7, 23	Volume	15
Piano Room	105	Step Recording	54, 61	VRM	75
Pitch Bend	39	Stereophonic Optimizer	96		
Pitch Bend Range	73	Stop ACMP	78	W	
Pitch Detect	26	Stroke	59	WAV	85
Pitch Shift	60	Style	78	Wireless LAN	101
Play Root/Chord	58	Style Characteristics	80	WPS	101
Poly	41, 43	Style Creator	48		
Portamento	39	Style File Format	57	X	
Portamento Time	43, 73	Sustain	39	XG Voice	77
Punch In/Out	83, 84, 85	Swing	55		
		Synchro Stop Window	79	Y	
		System Effect	12	Your Tempo	81
Q		T			
Quantize	19, 56, 71, 72	Talk	25, 27		
Quick Start	82	Talk Mixing	26		
		Tap Tempo	89		
R		Temperament	86		
Ratio	16, 25	Tempo	5		
Realtime Recording	51, 61	Text	21		
Record	32	Threshold (Th.)	16, 25		
Registration Freeze	37	Time	103		
Registration Memory	35	Time Signature	89		
Registration Sequence	35	Time Stamp	97		
Release	44	Touch Screen	97		
Repeat Mode	82	Touch Sense	43		
Resonance	44	Touch Sensitivity	88		
Restore	99	Touch Sensitivity Depth	43		
Retrigger	60	Touch Sensitivity Offset	43		
Reverb	14	Transpose	6, 72		
Root Fixed	58	Tremolo	24		
Root Trans (Root Transpose)	58	Trill	24		
Rotary Speaker	46	Tuning	73, 86		