

**YAMAHA**

**RX15**

DIGITAL RHYTHM PROGRAMMER

OWNER'S MANUAL

# CAUTIONS

Thank you for your choosing the Yamaha RX-15 Digital Rhythm Programmer.

THE RX-15 rhythm machine represents the culmination of Yamaha's advanced music/electronic technology, and uses a sophisticated PCM sound source. Nearly any sort of rhythm pattern can be created, and since the sounds are digitally recorded, they are indistinguishable from "live" acoustic percussion instruments.

To assure that your RX-15 will give you many years of reliable performance, please be sure to read this operation manual carefully before attempting to operate the unit.

## FEATURES

\* The RX-15 has a simple, microprocessor controlled all-digital design and offers a wide variety of functions. The functions are selected by switches and the data is entered using data entry sliders or switches.

\* A high quality digital PCM sound source is used to produce the RX-15 voices. With 8 quantizing bits (exponential data compression equivalent to 14 bits), the RX-15 delivers a natural, wide dynamic range. With 4 state-of-the-art 256 kilo-bit ROM memory chips, the reality of the sound transcends the limits of previous PCM rhythm machines.

\* 15 different sounds are provided, and the level, accent level, pan (stereo positioning) can be independently programmed for each one.

\* Partial rhythm patterns (pattern) can be programmed and connected together to form entire pieces (songs). The RX-15's advanced editing functions will also be extremely useful when programming different songs.

\* The number of notes, the number of bars, and the bar division can all be independently set enabling you to program any sort of rhythm pattern.

\* Large memory capacity is also another major feature of the RX-15. The RX-15 is capable of memorizing up to 100 patterns, 10 songs, and bar divisions of up to 1/192.

\* A 16 character LCD (Liquid Crystal Display) is used to display the data. Combined with a simple, comprehensive panel layout, this assures that the RX-15 is easy to program and use.

\* The RX-15 also features MIDI input and output terminals. These enable the RX-15 to be connected to sequencers, synthesizers, computers and other external MIDI compatible devices, for a wider range of performance applications.

## Location

Placing the unit in the following locations may cause it to malfunction and should therefore be avoided.

- \* Places that are subject to direct sunlight.
- \* High temperature locations such as in close proximity to heating units.
- \* Places with excessively high or low humidity.
- \* Places that are prone to excessive dust.
- \* Places that are subject to vibrations.

## Power supply

\* Be sure to connect the RX-15 to an AC mains supply line that meets the power supply specifications listed on the rear panel.

\* If there is any danger of lightning occurring nearby, remove the power plug from the wall power socket in advance.

## Connections

\* Read section 2-3 "Rear Panel" on page 13, and make the proper unit connections.

\* To avoid damaging your speakers and other playback equipment, turn off the power of all the units before making connections.

## Handling and Transportation

\* Avoid subjecting the switches and knobs to excessive force.

\* To avoid broken cords and short-circuits, be sure to unplug all connectors by grasping the respective plugs--NOT the cords--when removing power plugs from the wall power socket or connection cords from other units. Additionally, remove the power plug from the wall power socket when not using this unit for a long period of time.

\* To prevent damage to the cords and short-circuits during transportation, remove the power cord and all connection cords before attempting to move this unit.

## Caring for the Exterior Finish

\* Do not wipe off the exterior with benzene, paint thinners or other solvents. Additionally, do not use insecticides or other pressurized air spray products nearby.

\* Wipe off any dust or dirt with a soft, dry cloth.

# TABLE OF CONTENTS

## The Warranty/Storing the Operation Manual

\* When you purchase this product, be sure to have the product warranty filled out by the store where you purchased the unit.

\* After you have finished reading this operation manual, be sure to keep it together with the product warranty in a safe place. It also might be a good idea to make a photo copy of this operation manual for quick and handy reference.

## Effects on Other Electronic Equipment

\* Since this unit principally uses digital circuitry, simultaneous use of radios, TVs and other electrical equipment nearby may result in noise and erroneous operation. If this should happen, be sure to separate the units by a distance sufficient to remove this problem. It is also a good idea to use separate line filters for each unit.

## CAUTION

The RX15 PATTERN MEMORY locations 00 through 36 contain pre-programmed rhythm patterns when the unit is shipped. Use the SAVE function to save these patterns onto cassette tape before programming your own patterns, to prevent accidental erasure of the pre-programmed patterns.

<b>PART1</b>	<b>RX15 Unit Outline and PCM Recording</b>	<b>4</b>
1-1	Outline of RX15	4
1-2	Outline of the PCM Recorded Sound Source	4
<b>PART2</b>	<b>The Function of Each Section</b>	<b>7</b>
2-1	The 4 Modes	7
2-2	The Control Panel	8
2-3	Rear Panel	13
<b>PART3</b>	<b>PATTERN MODE/Rhythm Pattern Programming</b>	<b>15</b>
3-1	Selecting Patterns	15
3-2	Real Time Write	16
3-3	Step Write	18
3-4	Copy	20
3-5	Swing	22
3-6	Quantize	23
3-7	Click	24
3-8	Clear	25
3-9	Tempo	27
3-10	Play Pattern	28
<b>PART4</b>	<b>SONG MODE/Program For Constructing and Finishing Songs</b>	<b>29</b>
4-1	Select Song	29
4-2	Edit	30
4-3	Insert	31
4-4	Delete	31
4-5	Repeat	32
4-6	Tempo Change	34
4-7	Clear	36
4-8	Tempo	37
4-9	Play Song	37
<b>PART5</b>	<b>FUNCTION MODE</b>	<b>38</b>
5-1	Sync	38
5-2	Cassette	39
5-3	Save/Verify	39
5-4	Load	40
5-5	Inst	41
5-6	MIDI IN/OUT	42
<b>PART6</b>	<b>SPECIFICATIONS</b>	<b>46</b>
6-1	Specifications	46
6-2	Block Diagram	46
<b>APPENDIX</b>	<b>Pattern Diagram</b>	<b>47</b>

# Part 1 :RX15 UNIT OUTLINE and PCM RECORDING

## Section 1-1 -- Outline of RX-15

Figure 1 is a block diagram that shows the basic structure of the RX-15. As can be seen from the figure, the following five principal sections comprise the RX-15.

1. Control Panel
2. MPU (Micro Processor Unit)
3. LCD (Liquid Crystal Display)
4. PCM sound source
5. D/A (Digital/Analog) Converter

Referring to figure 1, let us explain the configuration and the outline of the RX-15.

Fig 1 RX15 Block Diagram (abb.)

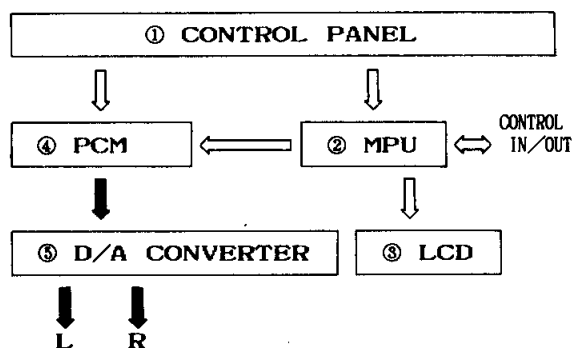

### 1. Control Panel

The control panel is equipped with switches and sliders and is used to control the MPU (Micro Processing Unit) and the PCM sound source.

### 2. MPU (Micro Processor Unit)

This section is equivalent to the CPU (Central Processing Unit) of a computer. It processes the commands sent to it from the control panel. Additionally CONTROLS IN/OUT on the right corresponds to the MIDI IN/OUT, CASSETTE IN/OUT and FOOT SW inputs and outputs.

### 3. LCD (LIQUID CRYSTAL DISPLAY)

The liquid crystal display of the RX-15 is capable of displaying up to 16 characters.

### 4. PCM Sound Source

See section 1-2 "Outline of PCM Recorded Sound Source". The RX-15 uses digitally recorded PCM (Pulse Code Modulation) sound sources to produce truly realistic sounds. Naturally this includes the sound envelope shapes as well. Owning an RX-15 is equivalent to having a virtuoso drummer with a full drum set at your disposal.

### 5. D/A (Digital/Analog) Converter

This circuit converts the digital code (101101...) from the PCM sound source into analog signals (real instrument sounds).

## Section 1-2

### Outline of the PCM Recorded Sound Source

The PCM recording and playback system operates by coding analog musical signals into a digital code (100111...), and then decoding the digital signals to accurately reconstruct the original analog music waveform. The PCM reproduction system offers enormous musical data processing capability, assuring you of high quality sound reproduction that is impossible to achieve on conventional systems. PCM stands for Pulse Code Modulation. The overall system has three main processes: sampling, quantizing and encoding.

#### 1. Sampling

The sampling process "samples" the amplitude of a continuous music signal at precisely timed intervals. (See ABC of figure 2a.)

#### 2. Quantizing

Quantizing measures--"quantizes"--the amplitudes (A, B, C,...) derived from the sampling process. This results in the stepped waveform shown in figure 3a.

#### 3. Encoding

Encoding converts the quantized amplitudes to a binary code (digital code), and transmits this as a serial pulse train (figure 4).

Fig 2 Sampling

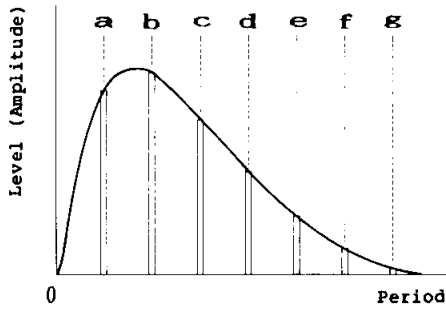

(b) Approximating Held Signals

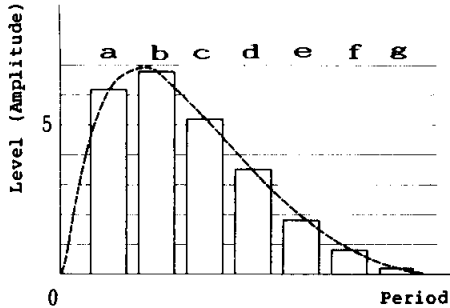
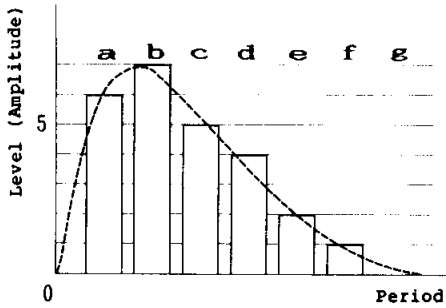

Fig 3 Quantizing

(a) Quantizing



(b) Indirect Quantizing

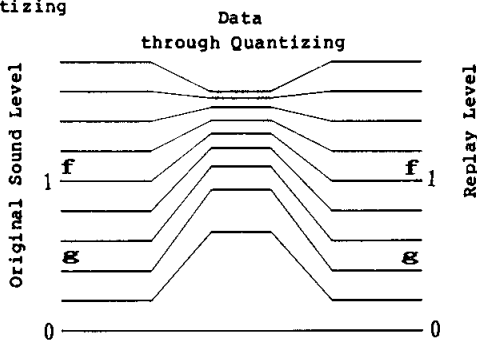

Fig 4 Coding



There you have a very simple outline of the PCM recording process. A more detailed discussion of that process follows.

1. Sampling

(Fig. 2a, 2b)

\* As shown in fig. 2a, sampling represents continuous musical signals by the amplitudes of discrete pulses of uniform width (Fig. 2a A, B, C, ...) The frequency of the pulses is termed the sampling cycle ( $T_s$ ). In order to sample continuously changing musical data without losing any information, PCM recording employs a very important theorem known as the "sampling theorem".

\* The sampling theorem is as follows:  $W$  (Hz) is the highest frequency contained in the musical signals. If the musical signals are sampled with a frequency in excess of  $2W$  (Hz) the resultant pulse train will contain the entire contents of the original musical signals. Therefore, if the musical signals do not exceed 1 kHz in frequency, they can be accurately sampled with a frequency of 2.1 kHz; or in other words, the entire music signal can be reproduced if it is sampled once every  $1/2100$  second. Now this may seem like a gross mis-calculation, since there should be an infinite number of points arranged to form a smooth curve.

\* However, this applies only for the high frequency components in excess  $W$  (Hz), which are not contained in the original frequency range. When the precondition of a frequency component of  $W$  (Hz) or under is applied, there is only one possible curve.

Reference: sampling theorem

Now, let us try to mathematically prove the sampling theorem. To simplify the calculations, let us take the input signal to be equivalent to a sine wave. Input signal equals  $I \sin Pt$ . If we then apply a Fourier progression to the sampled pulses, the results are as follows:

$$I \sin Pt \left\{ \frac{1}{2} + \frac{2}{\pi} \left( \frac{1}{2N+1} \sin(2N+1)Ct \right) + \frac{1}{2} \sin Pt + \frac{2}{I} \left( \frac{1}{3} \sin Pt \sin Ct + \frac{1}{5} \sin Pt \sin 3Ct + \dots \right) \right\}$$

To avoid a distorted signal resulting from the P component in the input signal superimposing on the C-P components created by the sampling pulses, the conditions of C-P -- P must be fulfilled. In other words,  $C = 2P$ .

\* In the sampled points, the signals held for a time equivalent to sampling cycle  $T_s = 1/f_s$  are termed held signals (i.e. sample and hold) (Fig. 2b).

## 2. Quantizing

(Fig. 3a, 3b)

Quantizing is the process following sampling. Quantizing indicates that when depicting a certain quantity, the quantity is to be represented using whole number multiples of the minimum unit quantity known as quantizing bits. In other words, each quantized sample is "rounded off" to the nearest available value. Naturally there are some slight discrepancies between the original wave form and the quantized wave form (Fig. 3a).

\* These discrepancies are referred to as quantizing error, which results in quantizing noise. Regardless of the level of the input signal, quantizing noise remains at a uniform level. Therefore when the level of the input signal is high, the ratio of the signal to the quantizing noise (S/N q) is small, and poses no problems. However when the level of the input signal is low, the S/N q ratio is large and therefore the audio signal may be obscured by the quantizing noise. To avoid this problem, it is therefore necessary to adjust change the quantizing steps (units of measurement) according to the signal amplitude level. This is termed non-linear quantizing. However, since non-linear quantizing cannot be carried out mechanically, in actuality "compression and expansion" is used. This has the same effect as non-linear quantizing.

\* As depicted in Fig. 3b, compression uses a logarithmic ratio to compress the amplitude of the signal itself (dynamic range). This increases the level of very low level input signals in relation to the high-level signals, permitting a relatively finer unit of to be used for quantizing, which means that quantizing noise can be held within a range that will not affect the musica data. After undergoing linear quantizing, the compressed signal is then expanded back to its original amplitude. This is the same method used by some noise reduction systems. Regardless of the level of the input signal, this assures a high S/N q ratio (signal to quantizing noise ratio), and achieves a wide dynamic range that is impossible to achieve with analog sound sources.

## 3. Coding (Fig. 4)

As we saw earlier the sampled music signal undergoes quantizing, which converts it to a train of discrete level values. This signal is then digitally coded (100110...) into a form appropriate for recording and transmission. This process is referred to as coding. What coding does is convert the quantized amplitude value into a binary code using only ones and zeroes. Each digit in the binary system is termed a bit. The RX-15 uses an eight bit system which provides equivalent performance to a 14 bit system. The pulse amplitude signal is converted into a train of

corresponding binary values, and is then recorded and transmitted. (Fig. 4 depicts the converted pulse signals).

There you have an outline of the PCM recording system. In any case, rather than deal with continuously and randomly variable quantities, it is much more accurate and reliable to deal with whole number multiples of precise quantities that occur at precise intervals. This also simplifies corrections should signals occur outside of the designated time intervals, or the variable quantity does not prove to be a whole number multiple of the quantizing steps. Digital PCM systems are nearly immune to external noise and sound degradation which occurs during transmission. This is the reason why digital PCM systems are used by space communications systems, which are required transmit signals over truly astronomical distances, and broadcast systems, which always require the highest sound quantity possible. This same PCM recording system is employed for the RX-15, making it possible to deliver the most realistic, dynamic rhythm sounds available.

### The PCM Voice Memory

In the RX-15, the sound of each instrument (each voice) is recorded in 8-bit form. Each group of 8 bits is referred to as a "byte", and represents one sampled amplitude. Each voice is actually recorded using many bytes, which include data corresponding to the waveform of the recorded instrument from its initial attack to final decay.

\* Even though the PCM sound data of the RX-15 uses only 8-bits, data compression gives it a dynamic range equivalent to 14 bits (more than 80 dB).

\* The PCM sound source of the RX-15 uses four 256 kilo-bit ROM (Read Only Memory) chips, enabling it to store massive amounts of waveform data.

### Pulse Wave Data Decoding.

The digital PCM waveform is decoded according to the presence or absence of a pulse (1 or 0, respectively). In the pulse wave shown in figure 4, three data bits are represented by three pulses. In the RX-15, eight pulses are used to represent one byte of data.

# Part 2: THE FUNCTIONS OF EACH SECTION

## Section 2-1 -- The 4 Modes

### 1. PATTERN Mode

This mode is used to designate the number of measures and the number of beats when creating partial rhythm patterns. Up to 100 patterns can be programmed into the RX-15. The various pattern mode functions are operated via the upper row of black keys, located immediately beneath the LCD display panel. Each function is labelled above the key in white lettering (see Figure 5).

The pattern mode is activated when power is turned on, an indicator above the PATTERN/SONG key will light to confirm this. The message "SELECT PTN 000" will appear in the LCD panel, prompting you to select the desired parameters for pattern creation.

### 2. SONG Mode

This mode is used to combine a number of different patterns into a series of rhythm patterns constituting an entire SONG or composition. Rhythm patterns for up to 10 different songs can be programmed into the RX-15.

The various song mode functions are operated via the same upper row of black keys located immediately beneath the LCD display panel. Each song mode function is labelled beneath the key in purple lettering (see Figure 5).

The SONG mode is activated by pressing the PATTERN/SONG key, and an indicator beneath the key will light to confirm activation of this mode. The message "SELECT SONG 000" will appear in the display panel, prompting you to select the desired parameters for SONG creation.

Fig 5 Control Panel

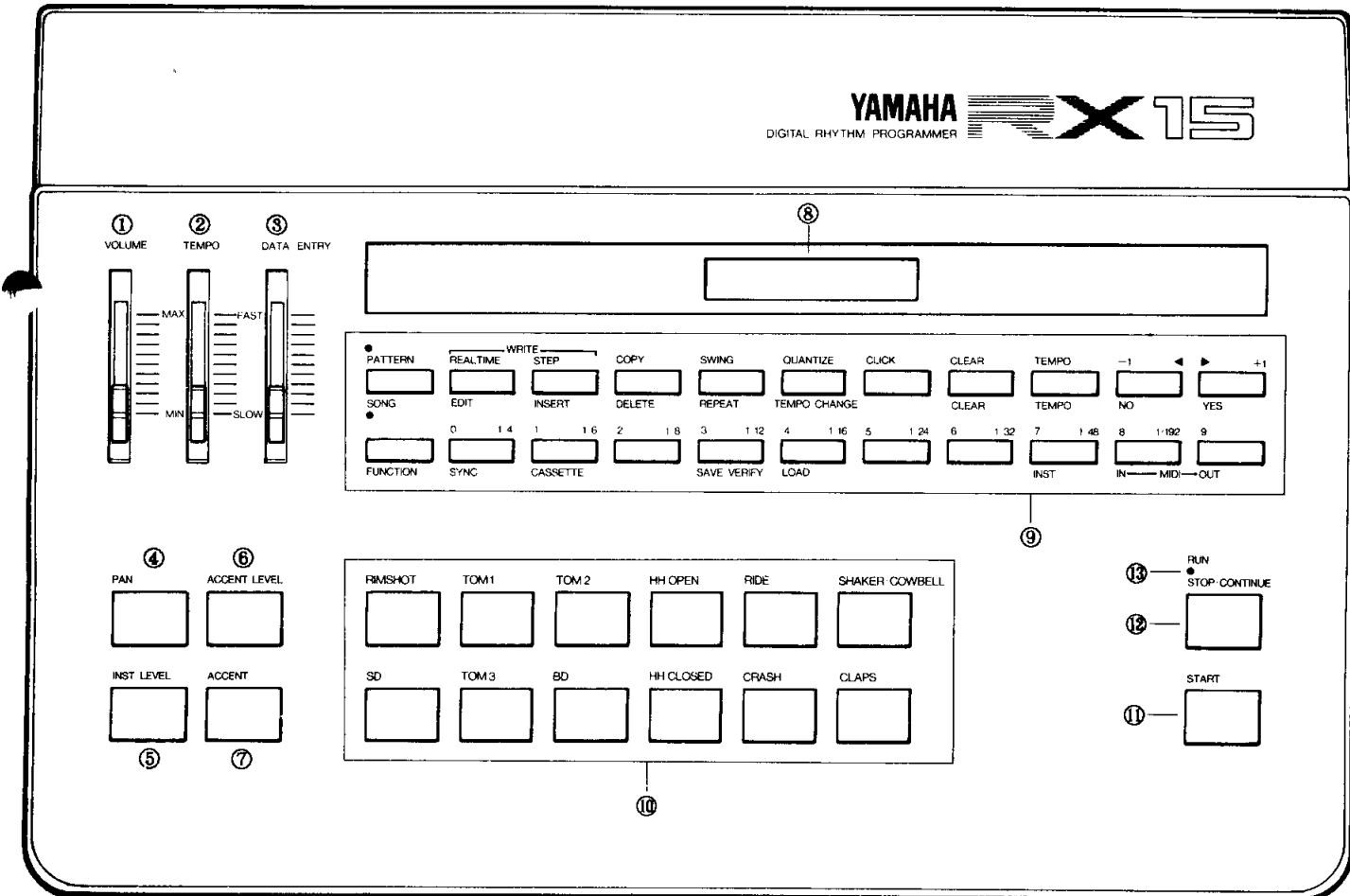

### 3. FUNCTION Mode

This mode deals with transmission and reception of data external to the RX-15, including MIDI data exchange and cassette tape data exchange.

The various functions of this mode are operated via the the lower row of white keys located beneath the display panel. Each function is labelled beneath the key in purple lettering.

The FUNCTION mode is activated by pressing the desired parameter key while the FUNCTION key is pressed. A message display for each of these parameters will appear in the display panel.

### 4. PLAYBACK Mode

This mode permits playback of patterns and songs created with the RX-15. The PLAYBACK mode is activated by pressing the red START button while either the "SELECT PTN 000" or "SELECT SONG 000" message is displayed. The indicator labelled RUN will light, and playback will begin (see Figure 5).

During playback of a pattern, the message "PLAY PTN 000" will appear in the display panel. During playback of a song, the message "SONG 00 - PART 001" will appear in the display panel.

## Section 2-2 -- The Control Panel

Depending on which of the four modes is activated at any given time, the various parameter and control keys on the RX-15 will serve different functions. Each function of all control panel keys will now be explained, beginning from the left hand side of the control panel.

### 1. VOLUME Control (see Figure 6)

This is the master volume control for the RX-15. It simultaneously controls the output level of the 12 instruments (from RIMSHOT to CLAPS) found on the lower center portion of the control panel. Output level from both the rear panel Output L/R jacks and the Phones jack is controlled by the sliding VOLUME control. It functions independently of the 4 mode settings.

Fig 6 VOLUME, TEMPO, and DATA ENTRY Slider Controls.

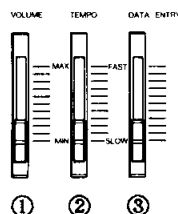

### 2. TEMPO Control (see Figure 6)

This controls rhythm tempo during playback of a pattern or song, or during pattern creation. Tempo is variable over a range of 40 to 250 beats per minute.

When the TEMPO control is used during pattern creation, a numerical tempo value is displayed in the LCD panel, and fine adjustments in 1 beat increments are possible. The TEMPO control functions independently of the 4 mode settings.

### 3. DATA ENTRY Control (See Figure 6)

The DATA ENTRY control is used to set the desired parameters when using the following functions: PAN, INST LEVEL, ACCT LEVEL, MIDI IN/OUT, and REAL TIME WRITE.

When using the PAN function, the DATA ENTRY control determines the relative left/right stereo positioning of each instrument.

When using the INST LEVEL function, the DATA ENTRY control sets the relative output level of each instrument.

When using the ACCT LEVEL function, the DATA ENTRY control sets accent note level for each instrument.

When using the MIDI IN/OUT functions, the DATA ENTRY control is used to designate the MIDI channel.

When writing in rhythm patterns with the REAL TIME WRITE function in the pattern mode, the DATA ENTRY control sets the volume of the rhythm guide (CLICK).

### 4. PAN Button (purple, Figure 7)

The PAN function allows you to position each instrument at any desired location within the stereo sound field, ranging from the left to right channels. The PAN function is engaged by pressing the PAN button while either the "SELECT PTN 000" or "SELECT SONG 000" message is displayed while in the pattern or song modes. It may also be engaged when the playback mode. When engaged, the message "PAN LEVEL" will appear in the display panel.

Then, one of the 12 instruments (from RIMSHOT to CLAPS) is selected by pressing its corresponding button, and the following message is displayed in the panel: "XXXX L = ll 0 R = rr". "XXXX" refers to the name of the instrument, "ll" refers to left channel level, and "rr" refers to right channel level.

Fig 7 PAN, INST LEVEL, ACCENT LEVEL, and ACCENT Buttons.

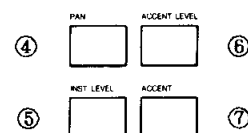



The DATA ENTRY control is then used to locate the selected instrument in the stereo sound field. With a setting of  $L = 01$   $R = 15$ , the instrument will be located in the right channel only, and with a setting of  $L = 15$   $R = 01$ , the instrument will be located in the left channel only. Correspondingly, a setting of  $L = 08$   $R = 08$  will locate the instrument in the center.

When using the left and right Outputs for a monaural signal output, the PAN position for all instruments should be set to this center position.

When one button is labelled with two instrument names (e.g. SHAKER/COWBELL), the PAN position can be independently set for each instrument by switching between them with the INST key in the bottom upper row of keys on the control panel.

When the PAN function is engaged, it is possible to directly activate the PATTERN, SONG, and FUNCTION modes, as well as INST LEVEL and ACCT LEVEL.

Pressing the PAN button a second time disengages the function. PAN settings can be individually determined for each particular pattern and song created with the RX-15.

#### Operating Procedures (see Figure 8)

- A. Activate the Select Pattern or Select Song display.
- B. Engage the PAN function by pressing the PAN button. (This can be done during playback of a song or pattern as well.)
- C. Activate the PAN data display by selecting a particular instrument.
- D. Determine the PAN position using the DATA ENTRY control.
- E. Repeat steps C and D for each of the instruments used.
- F. Disengage the PAN function by pressing the PAN button a second time.

#### INST LEVEL button (purple, Figure 7)

The INST LEVEL function allows you to set the output level of each instrument independently. It can be activated while the "SELECT PTN 000" or "SELECT SONG 000" messages are displayed while in the pattern or song modes, or while in the playback mode. When engaged, the message "INST LEVEL" appears in the display panel. When an instrument is selected, the following display will appear in the display panel: "XXXX Level ii0". "XXXX" refers to the instrument selected, and "ii" refers to a numerical value for output level. The DATA ENTRY control is used to set the output level, from a range of 00 (off) to 31 (max).

When two instruments share a single button, such as SHAKER/COWBELL, the output level can be set independently for each by switching between them with the INST button on the row of function keys below the display panel.

The INST LEVEL function is disengaged by pressing the button a second time.

When the INST LEVEL function is engaged, it is possible

to directly activate the PATTERN, SONG, and FUNCTION modes, as well as the PAN and ACCT LEVEL functions. INST LEVEL settings can be individually determined for each particular pattern and song created with the RX-15.

#### Operating Procedures (See Figure 8)

- A. Activate the Select Pattern or Select Song display.
  - B. Activate the INST LEVEL function by pressing the INST LEVEL button. (This can be done during playback of a song or pattern as well).
  - C. Select an instrument and activate the data display.
  - D. Set the INST LEVEL with the DATA ENTRY control.
  - E. Repeat steps C and D for each instrument used.
  - F. Disengage the INST LEVEL function by pressing the INST LEVEL button a second time.
6. ACCT LEVEL (purple, Figure 7)

This function controls the level of accent applied to each accented note for each individual instrument within the rimshot to claps range. The accent level is activated by the ACCENT LEVEL button when the SELECT PATTERN display (SELECT PTN pp0) or the SELECT SONG display (SELECT SONG ss0) is shown, or in PLAYBACK MODE. The ACCENT LEVEL display will appear on the LCD. By pushing the INSTRUMENT button, the DATA display prompt (xxx AC LEVEL aa) will be shown. Here "xxx" represents the name of the individual instrument and "aa" is the specific level of accent you desire. The ACCENT LEVEL button acts as a toggle switch--push it once and it's activated; push it again and it is disengaged.

The accent level can vary between no accent (00) to maximum accent (31) and is set by use of the DATA ENTRY SLIDER. Even if two instruments share the same INSTRUMENT button, such as SHAKER/COWBELL on the same button, the level can be independently set on the RX-15 and the instruments can be switched by using the INST function of the FUNCTION mode.

The ACCENT LEVEL is added to the INST LEVEL of the instrument. It is necessary to preset the level of unaccented notes for the accented instrument by use of the INST LEVEL function. If the INST LEVEL of an instrument is set to the maximum 31 setting, no accenting of notes for that instrument is possible.

You can directly activate the functions of the PATTERN, SONG and FUNCTION modes, as well the PAN and INST LEVEL functions while using the ACCENT LEVEL function. And, like the INST LEVEL, the ACCENT LEVEL ~~is~~ can be set individually for each pattern and song created by the RX-15.

#### Operating Procedures (See Figure 8)

- A. Activate the SELECT PATTERN or SELECT SONG display.
- B. Activate the ACCENT LEVEL function by pressing the ACCENT LEVEL button. (This can be done during playback of a song or pattern as well.)

C. Activate the DATA display by pressing the INSTRUMENT button.

D. Select instrument and level of accent by using the DATA ENTRY control.

E. Repeat steps C and D for each instrument used.

F. Disengage the ACCENT LEVEL function by pressing the ACCENT LEVEL button a second time.

Fig 8 PAN Function, INST LEVEL Function, and ACCENT LEVEL Function Operating Procedures.

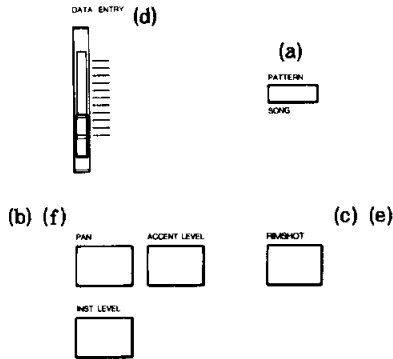

MODE Selectors (Green, Figure 10)

These keys allow you select PATTERN, SONG, and FUNCTION modes.

a) PATTERN/SONG

This key allows you to switch between PATTERN and SONG modes by either entering a Pattern (SELECT PATTERN display) or Song (SELECT SONG display) number you wish.

b) FUNCTION

This key will activate the function mode.

MODE Indicators (Figure 10)

c) PATTERN Indicator

This indicator will light up while using the PATTERN mode and will light up with the SONG indicator when using the CASSETTE function of the FUNCTION mode.

d) SONG Indicator

This indicator will light up while using the SONG mode and will light up with the PATTERN indicator when using the CASSETTE function of the FUNCTION mode.

7. ACCENT button (green, Figure 7)

When this button is pressed during PATTERN programming or Real Time Performances it designates an accented note. If the ACCENT and INSTRUMENT buttons are pressed simultaneously during PATTERN programming, the accented note is memorized by the RX-15. Pressing these two buttons simultaneously during Real Time performances will accent only the note being played.

8. Liquid Crystal Display, or LCD (Figure 9)

The 16 character liquid crystal display will show the functions used and data entered while operating the RX-15. While the DATA ENTRY and OPERATION SELECT displays are on the LCD, a cursor (0) will appear for easier data entry.

9. PARAMETER Keys (Figure 9)

These keys select the the functions of the PATTERN, SONG, and, FUNCTION modes. The keys are arranged in two rows below the LCD.

Fig 9 Parameter Keys and LCD

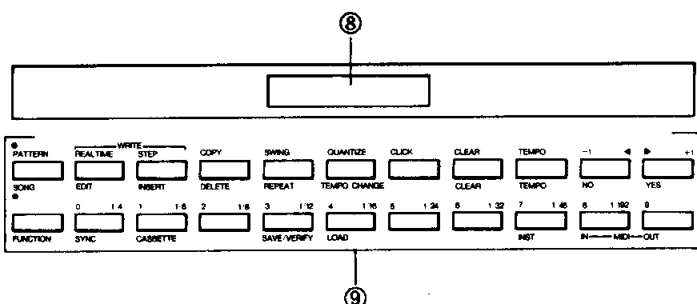

PATTERN Mode Parameters (Black, Figure 11)

This group of keys is used to create Patterns. The character markings for these keys are in white. In order to create a Pattern activate the SELECT PATTERN display and use the following functions.

a) REAL TIME WRITE

This function can incorporate instruments on the INSTRUMENT button into a Pattern while listening to the Click Rhythm Guide for Real Time Performance.

b) STEP WRITE

This function enters notes into a Pattern on an individual basis from instruments on the INSTRUMENT button.

c) COPY

This function is used to combine two different Patterns into a single one, or to copy a Pattern that has been programmed onto a separate pattern number.

d) SWING

During playback, this function is used to add a driving, four-beat, jazz type rhythm to your Patterns. It creates a "Swing" sound by slightly delaying the beat timing of notes that fall on even beats.

e) QUANTIZE

Used while entering data, this function determines the length of each note.

f) CLICK

This function determines the of rhythm guide notes within a single measure.

g) CLEAR

This function will clear (erase) Patterns you have created. An "All Clear" is incorporated and will allow you to erase all your previous Patterns. Further, a single

Pattern, specific instruments within a Pattern, or specific notes for a specific instrument may also be cleared using this function.

**h) TEMPO**

This function is used to display the tempo on the LCD. It also allows you to make fine adjustments on each beat. The TEMPO function is used in both PATTERN and SONG modes.

**SONG Mode Parameters (Black, Figure 12)**

This set of functions is used to create the rhythm pattern for an entire song. The character markings for these keys are in purple. To create a song, activate the SELECT SONG display, and use the following functions. It should be noted, however, that functions b)--e) can only be employed after using a) (edit).

**a) EDIT**

The EDIT function is the central component of the SONG mode. It combines different Patterns into a single rhythm pattern for an entire composition and allows those patterns to be edited, making song creation on the RX-15 versatile and easy.

**b) INSERT**

This function is used to insert desired Patterns into a Song.

**c) DELETE**

This function is used to delete unnecessary portions of a Song.

**d) REPEAT**

This function is capable of repeating single or multiple Patterns up to 100 times.

**e) TEMPO CHANGE**

This function is used to designate a change of Tempo within a Song.

**f) CLEAR**

This function erases (clears) songs. It incorporates an "All Clear" which will erase all Songs you have created. It will also clear a single Song.

**Fig 10 Mode Selectors and Indicators**

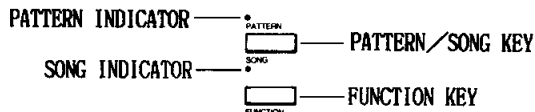

**Fig 11 Pattern Mode Parameters**

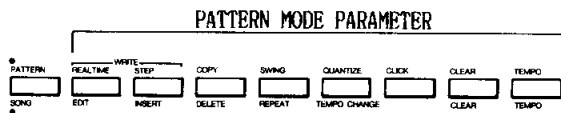

**g) TEMPO**

This function is used to display the tempo on the LCD. It allows the fine adjustment of each beat. The TEMPO function is used in both SONG and PATTERN modes.

**FUNCTION MODE Parameters (White, Figure 13)**

The FUNCTION MODE allows you to choose various functions from the SELECT PATTERN or SELECT SONG displays by simultaneously pressing the buttons for the desired function and the FUNCTION button located on the left hand side of the panel. Functions c) and d) can be employed only after using function b) (CASSETTE). None of the functions have been programmed into unmarked buttons.

**a) SYNC**

This function is used to synchronize the RX-15 with an external pulse wave or MIDI clock.

**b) CASSETTE**

This function is used to transfer data to and from the RX-15 and an external cassette tape unit. The CASSETTE function is the master parameter for c) (SAVE/VERIFY) and d) (LOAD)

**c) SAVE/VERIFY**

This function is used to copy the data stored in the RX-15's memory to a standard cassette tape. The SAVE sub-function transfers the data, while the VERIFY sub-function checks the data after it has been copied.

**d) LOAD**

This function is used to load data stored on external cassette tape into the internal memory of the RX-15.

**e) INST**

This function is used to select a specific instrument when two instruments share an INSTRUMENT button.

**f) MIDI IN**

This function is used to designate the reception of digital signals from the MIDI IN terminal.

**g) MIDI OUT**

This function is used to designate the reception of digital signals from the MIDI IN terminal.

**Fig 12 Song Mode Parameters**

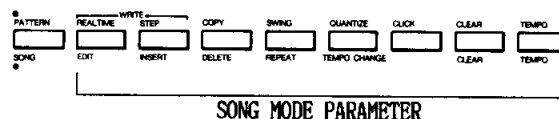

**Fig 13 Function Mode Parameters**

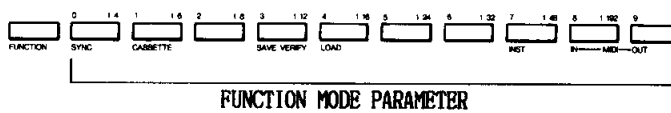

**INCREMENT/DECREMENT Key (Red, Figure 14)**

This key is used for making commands or changing entered data when you are designating a Pattern number or selecting a function. The character markings are in white for the INCREMENT/DECREMENT key, and the key can be used in PATTERN, SONG and FUNCTION modes.

**a) MINUS 1/NO**

This is used to designate NO commands or decrements.

**b) PLUS 1/YES**

This is used to designate YES commands and/or decrements.

**Fig 14 Increment/Decrement Key**



Decrement and "No" Command

Increment and "Yes" Command

**NUMBER Keys (White, Figure 15)**

These numerical keys are used to designate Pattern or Song numbers, or numbers during data entry. The keys' character markings are in white, and the keys can be used in PATTERN, SONG, and FUNCTION modes.

**Fig 15 NUMBER Key (Integer, Real Number)**

Integer or real number expressions should be used according to the function.

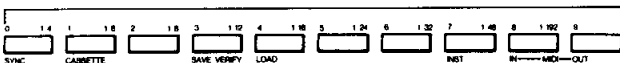

**10. INSTRUMENT button (Figure 16)**

This button is used to enter notes independently for each individual instrument during the writing (WRITE) of a Pattern. It can also be used for Real Time Performances.

**NOTE INPUT**

The NOTE INPUT function is used to incorporate and memorize notes into a Pattern. It is employed during the PATTERN mode, using the REAL TIME WRITE or STEP WRITE options of the WRITE function. By pressing the INSTRUMENT button a selected instrument sound will be heard and memorized into the Pattern.

**TABLE 1: INSTRUMENT Button designations (Figure 16)**

Code	Instrument Name	Sound
(a)*	RIMSHOT	Snare Drum Rimshot
(b)*	SD	MEDIUM — Deep-bodied Snare Drum
		HI TUNE — High-tuned Snare Drum
(c)	TOM 1	10" Deep-bodied Tom-tom
(d)	TOM 2	12" Deep-bodied Tom-tom
(e)	TOM 3	14" Floor Tom
(f)	BD	Bass Drum
(g)**	HH OPEN	Open High-hat
(h)**	HH CLOSED	CLOSED — Closed High-hat
		PEDAL — Pedalled High-hat
(i)	RIDE	Ride Cymbal
(j)	CRASH	Crash Cymbal
(k)***	SHAKER	Shaker
	COWBELL	Cowbell
(l)	CLAPS	Hand Clapping

\* RIMSHOT and SD can not be used together on the same beat. With the SD instrument, either MEDIUM or HI TUNE must be selected with the INST function of the function mode, and only the selected instrument will sound.

\*\* HH OPEN and HH CLOSED can not be used together on the same beat. With HH CLOSED, either CLOSED or PEDAL must be selected with the INST function of the function mode, and only the selected instrument will sound.

\*\*\* The SHAKER and COWBELL instruments can both be used on the same beat, and are used independently of each other. The desired instrument is selected with the INST function of the function mode. If both are used on the same beat, select SHAKER and COWBELL in turn with the INST function, and write in the pattern for each independently.

**Fig 16 INSTRUMENT Buttons**

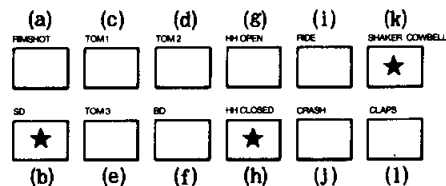

Two tone colors may be selected with each button by selecting the function mode or the instrument function.

## REAL TIME PLAY

This function enables Real Time Performances in the PLAYBACK, PATTERN, SONG or FUNCTION modes, by pressing the INSTRUMENT button. It is helpful after you have first programmed a basic rhythm pattern and wish to add fill-ins in Real Time during Playback.

Two caveats: First, none of the fill-ins will be memorized into the Patterns (for this, use the NOTE INPUT function described above), and secondly, it is not possible to layer notes over previously memorized notes for a given instrument.

### 11. START Button (Red, Figure 17)

This button is used to designate the starting of Playback for a Pattern or Song, and the beginning of Data entry when using the WRITE (REAL TIME WRITE, STEP WRITE) function.

#### START Button Functions

Pressing the START PLAYBACK button during the SELECT PATTERN or SELECT SONG display will activate Playback of a Pattern or Song and the RUN indicator (13) will light up to confirm this. During Playback, it is not possible to switch between SONG and PATTERN as the PATTERN/SONG button is temporarily disabled.

The Playback of a Pattern or Song can be temporarily halted by pressing the STOP CONTINUE button. Pressing this button again will continue playback from. However, by pressing START button after pressing the STOP CONTINUE button, the Pattern or Song will be played from the beginning.

The screen display (PLAY PTN pp:BRff) will appear during the playback of a Pattern. Here, "pp" represents the Pattern number and "ff" represents the bar count of the Pattern being played.

Similarly, the screen display (SONG ss PART xxx) will appear during playback of a Song: "ss" represents the Song number and "xxx" represents the part of the Song being played.

If the START button is pressed when using REAL TIME WRITE, or STEP WRITE option of the WRITE function, the INSTRUMENT button can write in notes, and a RUN indicator will light up to confirm this. The screen display (REAL T. W. BAR ff) will appear during the REAL TIME WRITE sequence. Here, "ff" represents the bar count within the pattern.

### 12. STOP/CONTINUE Button. (Purple, Figure 17)

Some of the functions of the STOP/CONTINUE button appear in the preceding discussion of the PLAYBACK button. The STOP/CONTINUE button is used in the PLAYBACK mode as well

as the FINISH/DISENGAGE options of the WRITE function.

In PLAYBACK mode, press the button to stop the Playback. The RUN indicator will go out to indicate that Playback has stopped. Press the STOP/CONTINUE button again and Playback will continue. If the START button is pressed after the STOP/CONTINUE button, the Pattern or Song will start from the beginning. Pressing the PATTERN/SONG button while Playback is halted will cause the RX-15 to disengage the PLAYBACK mode and the SELECT PATTERN or SELECT SONG display will appear on the LCD.

To select another Pattern or Song during Playback, press the STOP/CONTINUE button and the LCD will display the SELECT PATTERN or SELECT SONG prompt. Then, use the NUMBER keys to enter the number of the selected Pattern or Song.

Pressing the STOP/CONTINUE button while employing the REAL TIME WRITE or STEP WRITE options of the WRITE function will cause the RX-15 to disengage from that particular function.

### 13. RUN Indicator (Figure 17)

This indicator lights up when entering data during use of the REAL TIME WRITE option of the WRITE function, and during playback.

Fig 17 START Button, STOP/CONTINUE Button, and RUN Indicator

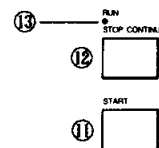

## Section 2-3 -- Rear Panel

All RX-15 connection terminals are found on the rear panel. Refer to the respective connection diagrams for proper connection to other electronic instruments, recording equipment, control equipment, or other peripherals. All connection terminals will be explained starting from the right hand side of the rear panel.

### 1. OUTPUT L--R (see Figure 18)

These are the left and right signal output phone plug terminals. Output level for both left and right channels is controlled by the front panel VOLUME control. The stereo sound field is created with the PAN control, by positioning individual instruments at different left/right locations. When the PAN position for any instrument is set to L=8 R=8, the same signal will be output from both the left and right channels.

2. PHONES (see Figure 18)

This is a stereo phone plug for headphone monitoring. Output volume is controlled by the front panel VOLUME control.

3. CASSETTE IN (see Figure 18)

This terminal serves double duty as the clock signal input for the external clock function (operating the RX-15 with a clock signal from an external rhythm machine or sequencer) and as a data input terminal to read in data from a cassette tape (LOAD function). This terminal is a mini phone plug.

When this terminal is used for clock signal input with the external clock function, clock output from a rhythm machine or sequencer is connected to this terminal and the SYNC function of the function mode should be set to EXTERNAL CLOCK. When this terminal is used for cassette data input, the cassette output is connected to this terminal and the LOAD function of the function mode should be selected.

4. CASSETTE OUT (see Figure 18)

This terminal is normally used for clock signal output, enabling rhythm machines and sequencers to be operated via the RX-15 clock. This terminal also functions as a data output terminal when SAVEing data onto external cassette tape memory. This terminal is a mini phone plug.

When this terminal is used for SAVEing data on cassette tape, the cassette recorder's Tape In terminal is connected to the RX-15 CASSETTE OUT terminal, and the SAVE/VERIFY function of the function mode should be selected. (Clock signal output from the RX-15 will be interrupted while the SAVE/VERIFY function is engaged.)

5. FOOT SW (see Figure 18)

A foot switch connected to this terminal can be used for stop and start control of PATTERN or SONG performance. Pushing the FOOT SW once will start the performance; pushing it again will stop the performance. When a performance is started, it always starts at the beginning of the song or pattern. The FOOT SW can also be used to start and stop REAL TIME WRITE functions.

Two foot switches are sold separately as options: FC-4, and FC-5.

6. MIDI IN (see Figure 18)

This terminal enables digital signal input for remote control of the RX-15 via external MIDI compatible instruments or devices.

This connection terminal is a 5-pin DIN terminal.

7. MIDI OUT (see Figure 18)

This terminal enables digital signal output for remote control of external MIDI compatible instruments or devices via the RX-15. This permits the creation of a complex music system with sequencers, synthesizers, computers, and even another RX-15 connected to the RX-15. During pattern or song playback, the MIDI OUT terminal outputs a MIDI clock signal.

This connection terminal is a 5-pin DIN terminal.

8. POWER SW (see Figure 18)

This is the RX-15 power switch. The RX-15 is equipped with battery backup power for memory protection, so data will not be erased from memory when the power is turned off.

Fig 18 Rear Panel

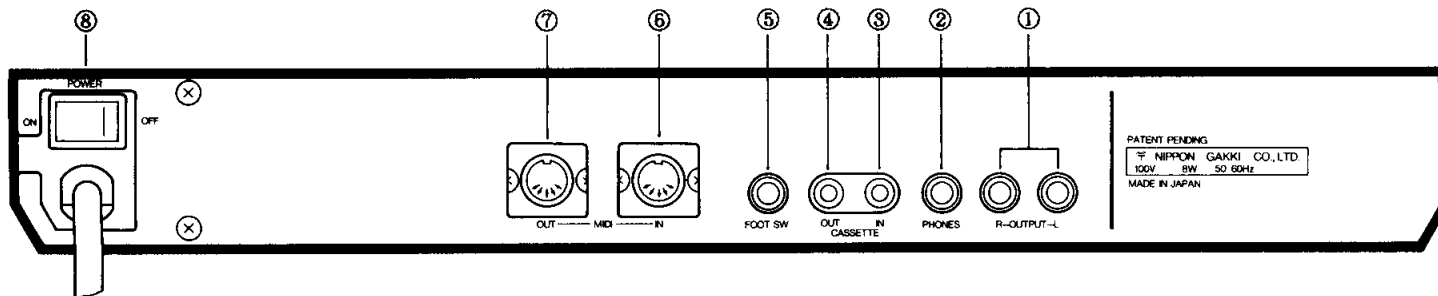

# Part 3: PATTERN MODE/Rhythm Pattern Programming

The PATTERN mode includes a group of functions that allow you to program rhythm patterns for a single measure, or for several measures. These are the individual units that are later combined to form an entire SONG or composition. Each partial rhythm pattern (of one or several measures) is referred to as a PATTERN.

## PATTERN Mode Operation

For purposes of efficiency when creating rhythm patterns, the following order of operating steps has been predetermined:

1. Select the PATTERN number. (3-1 Select Pattern)
2. Select the tempo. (3-9 Tempo)
3. Select the beat count of the rhythm guide. (3-7 Click)
4. Select the time scale of the notes to be written in. (3-6 Quantize)
5. Add a 4-beat swing feeling. (3-5 Swing)
6. Write in the rhythm. (3-2 Real Time Write) (3-3 Step Write)
7. Delete and correct errors in the PATTERN. (3-8 Clear) (3-2 Real Time Write) (3-3 Step Write)
8. Create PATTERN variations (3-4 Copy) (3-2 Real Time Write) (3-3 Step Write)
9. Playback the PATTERN. (3-10)

## MEMORY FULL Display

When the amount of unused memory remaining in the PATTERN memory is about to be exhausted, the Memory Full display (PTN MEMORY FULL) will appear in the display panel. When the amount of unused memory remaining is about to be exhausted, PATTERN programming operations can not be carried out after this display appears. Other PATTERNS not currently in use but still residing in memory should be cleared to free more memory. Efficient use of memory is always important when creating PATTERNS.

The Memory Full display will appear during PATTERN programming operations, and during activation of the Real Time Write, Step Write, and Copy functions.

When unused memory is exhausted, memory errors can occur with PATTERNS currently being programmed. It is therefore important that all currently unused PATTERNS be cleared from memory. Use the SAVE function to transfer all PATTERNS in memory onto external cassette tape memory, then clear memory

with the CLEAR function. This frees memory without fear of losing patterns currently stored in memory.

## 3-1 -- SELECTING PATTERNS

It is necessary to give each PATTERN a number in order to program, playback, erase, save, etc. your pattern. Designating a PATTERN number is done following display of the Select Pattern message which appears in the display panel upon entering the PATTERN mode.

The PATTERN mode is automatically entered when power to the RX-15 is turned on. Initially, PATTERN 00 will be selected. The message "SELECT PTN 00" will appear in the display panel (see Figure 19).

When switching to the PATTERN mode from other modes such as the SONG, FUNCTION, or PLAYBACK mode, the message "SELECT PTN aa" will appear. "aa" refers to the last PATTERN number called (see Figure 19).

PATTERN numbers are entered with the NUMBER keys and the +1/YES and -1/NO keys. Up to 100 pattern numbers can be designated, from 00 to 99. Patterns 00 to 36 already contain rhythm patterns prerecorded by Yamaha (refer to the RX-15 Pattern Book). When a PATTERN number has been entered, the message "SELECT PTN pp" will appear. "pp" specifies the PATTERN number selected (see Figure 19).

If the PATTERN number selected automatically is acceptable, a pattern number need not be entered, and operation can proceed to the next step. When the number keys or the +1/YES -1/NO keys are pressed during playback, the Play Pattern display will be cancelled and the Select Pattern display of the PATTERN number selected will appear.

Fig 19 SELECT PATTERN Display

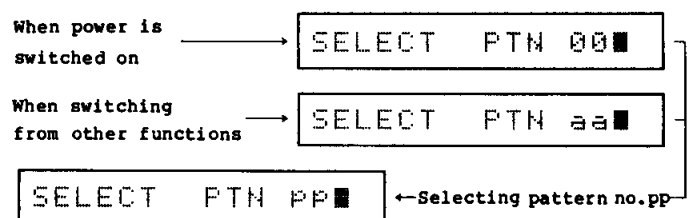

- A. Activate the Select Pattern display.
- B. Enter the desired PATTERN number with the NUMBER keys or the +1/YES -1/NO keys.
- C. To program a PATTERN, following the steps outlined in section 3-2.

To playback the PATTERN, follow the steps outlined in section 3-10.

Fig 20 Procedure for Selecting PATTERN

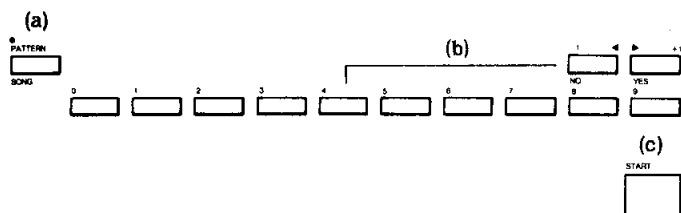

### Section 3-2 -- REAL TIME WRITE

This function enables rhythm patterns to be programmed in real time, generating a performance with the INSTRUMENT buttons while listening to the rhythm guide. The functions used and operating procedures will differ between I -- entering a completely new PATTERN, and II -- modifying an existing PATTERN.

#### I -- Entering a New Pattern

When using REAL TIME WRITE to enter data for a PATTERN that contains no rhythm data, the time signature is set first (steps 1 and 2), the number of measures is set (step 3), and the rhythm data is entered (step 4).

When the REAL TIME WRITE key is pressed while the Select Pattern display is displayed, step 1 (setting the time signature) will be activated.

Even if the SWING, QUANTIZE, CLICK, and TEMPO modes are activated, the REAL TIME WRITE function can be activated by pressing the REAL TIME WRITE key. Each time the REAL TIME WRITE key is pressed, the 3 steps will be repeated in the following cyclical order: Step 1, Step 2, Step 3, Step 1... Step 4 (writing in rhythm data) can be shifted to by pressing the START button while on any of the first 3 steps. If you are on any step between 1 and 4, pressing the STOP/CONTINUE button will disengage the REAL TIME WRITE function and return the RX-15 to the Select Pattern display.

Step 1. Setting the number of beats per measure (time signature).

The time signature display "REAL T.W. dd/ee" will appear in the display. "dd" refers to the number of beats. The basic setting for new PATTERNS is 4 beats per measure, and will be indicated as such by the display "REAL T.W.

04/4". Setting a different number of beats is done by entering the desired number with the number keys. Any number from 01 to 99 can be entered. (00 is an unacceptable number. If entered, no progress can be made until an acceptable number is entered.)

Step 2. Setting the length of each beat.

The length of each beat can be set by designating a quarter note, eighth note, sixteenth note, etc. These are selectable via the number keys labelled with a fractional expression (1/4, 1/8, etc.) above the keys. The range of options is from 1/4 to 1/32. If 1/48 or 1/192 is entered, the RX-15 will ignore the command.

Step 3. Setting the number of measures.

The length of each PATTERN is determined by setting the number of measures (bars). The Bar Number display "REAL T.W. ff BAR" will appear, with "ff" referring to the number bars. The desired bar number is entered via the number keys. Any number from 01 to 99 may be entered. (00 is an unacceptable value, and if entered, no progress can be made until an acceptable number is entered.)

Step 4. Writing in data

The RX-15 will now shift to the DATA WRITE IN mode when the START button is pressed. Listen to the rhythm guide and use the INSTRUMENT buttons to write in the notes (Fig. 21). However, notice that once even a single note has been written in, the time signature and bar number can no longer be changed (steps 1 -- 3).

The WRITE display (REAL T.W. PTN ff) will appear on the liquid crystal display. ff is the bar count that shows which bar number (determined on Step 3) is presently being used.

The pattern will return to the beginning after exceeding the number of bars set in step 3.

The beat of the rhythm guide that corresponds to the beginning of the bar will be accented. It is probably best to take up the count of the rhythm guide when it cycles for the first time, and to enter the data on the second time.

The volume of the rhythm guide can be set as desired with the DATA ENTRY slider. Additionally, the rhythm guide beat number can be set by using the CLICK function.

The notes for multiple instruments can be written in simultaneously.

While listening to the rhythm entered, it is possible to layer additional rhythm patterns on top for a more complex



effect.

Following the QUANTIZE function described in section 3-6, the timing of the notes will be corrected as they are being written in. For instruments that are primarily concerned with simply keeping the time, such as the cymbals (CYMBAL), this can be achieved simply by repeatedly pressing the corresponding INSTRUMENT button. When it is desired to enter specific notes on a specific part, for FILL IN, for example, the QUANTIZE function will compensate for up to a 50% deviation (compared to the length of the note) in the pressing of the INSTRUMENT button.

It is efficient to program a PATTERN by disabling the REAL TIME WRITE function for the notes and instruments as required, changing the QUANTIZE data, and using the WRITE ADDITION/CORRECTION-MODIFICATION function of Step II-3.

If the INSTRUMENT buttons are pressed with the ACCENT button held down, accented notes will be written in according to the ACCENT LEVEL set.

When entering 4-beat (jazz) rhythms, a realistic swing feel can easily be programmed by using the SWING function to slightly delay the notes on the even beats as determined by the QUANTIZE function.

Notes that were mistakenly entered can be erased simply by holding down the CLEAR key and pressing the corresponding INSTRUMENT button at the timing of the note to be erased.

Use the PATTERN DIAGRAM at the end of this text as a REAL TIME WRITE memorandum.

Fig 21 Example: Writing in with REAL TIME WRITE

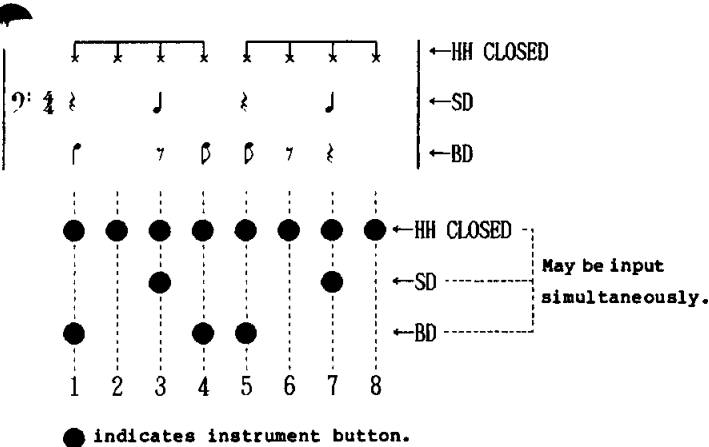

II: Modification of an existing PATTERN

Notes can be added and corrections can be made to a PATTERN that has already been programmed. However, the time signature and the bar number cannot be corrected. There are three main operating steps, which are Step 1: Checking the

time signature, Step 2: Checking the bar count, and Step 3: Adding and correcting notes.

Step 1 (checking the time signature) can be activated by pressing the REAL TIME WRITE key during the SELECT PATTERN display or while the respective function of the SWING, QUANTIZE, CLICK, and TEMPO modes are activated.

Step 1 (checking the time signature) and Step 2 (checking the bars count) will be alternately activated each time the REAL TIME WRITE key is pressed.

During either Step 1 or Step 2, pressing the START key will cause the function to shift to Step 3 (data addition and correction).

During Step 1, Step 2 or Step 3, pressing the STOP/CONTINUE button will cancel the REAL TIME WRITE function and return the RX15 to the SELECT PATTERN display.

The REAL TIME WRITE function can also be used for PATTERNS that have been entered using the STEP WRITE function.

Step 1: Checking the time signature

This function allows the confirmation of time signature data set when the rhythm was entered.

The time signature display (REAL T.W. dd/ee) will appear. The cursor (0) will flicker over the R at the beginning of the display. dd/ee represents the time signature (dd stands for the number of beats within the bar, and ee represents the note length of each beat).

The time signature data cannot be changed, even by pressing the NUMBER keys.

Step 2: Checking the bar count

This function enables confirmation of the bar count data set when the rhythm was entered.

The bar count display (REAL T.W. ff BAR) will appear. The cursor (0) will flicker over the R at the beginning of the display. ff stands for the number of bars.

The bar count data cannot be changed, even by pressing the NUMBER keys.

Step 3: Adding and correcting notes

The INSTRUMENT buttons can be used to add notes, after first activating the WRITE display by pressing the START button.

The contents of the function are identical to those for Step

I-4: Writing in data (notes)

The data additions and corrections can also be carried out by using the STEP WRITE function.

Operation procedure (Fig. 22)

- a) Activate the SELECT PATTERN display and designate the PATTERN number.
- b) Press the REAL TIME WRITE key and activate the time signature display (step 1).
- c) Using the NUMBER keys, enter the number of beats per measure.
- d) Press the REAL TIME WRITE key and activate the time signature display (step 2).
- e) Enter the type of note by using the NUMBER key.
- f) Press the REAL TIME WRITE key and activate the bar number display (step 3).
- g) Enter the bar number by using the NUMBER keys.
- \*\* Steps c), e) and g) can not be used with a finished PATTERN.
- h) Press the START button and activate the WRITE display (step 4).
- i) While listening to the rhythm guide, enter the notes by using the INSTRUMENT buttons.
- j) After you have finished writing in the data, press the STOP/CONTINUE button and return to the SELECT PATTERN display.
- k) Pressing the START button will play back the programmed PATTERN.
- l) Playback can be stopped by pressing the STOP/CONTINUE button. Additionally, you can return to the SELECT PATTERN display by pressing the PATTERN/SONG switch.
- m) Activate the different functions by using the REAL TIME WRITE key if required, adding or correcting data as needed.

Fig 22 REAL TIME WRITE Operating Procedure

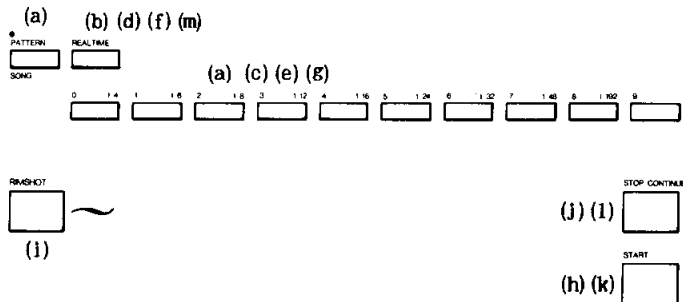

Section 3-3 -- Step Write

This function enables you to program the rhythm by using the INSTRUMENT buttons, entering the notes one by one. Notice that the functions and procedure will differ slightly between I (entering a completely new PATTERN) and II (modifying an existing PATTERN).

I: Entering a new PATTERN

When using STEP WRITE on a new PATTERN which has no rhythm data programmed, set the time signature (steps 1 and 2), set the number of measures (step 3), and write in the data (step 4).

When the STEP WRITE key is pressed during the SELECT PATTERN display, the following step 1 (setting the numerator of the time signature) will be activated.

Even while the respective functions of the SWING, QUANTIZE, CLICK, and TEMPO modes are activated, the STEP WRITE function can be activated directly by pressing the STEP WRITE key.

When the QUANTIZE data has been set to 1/192, the STEP WRITE function will not be activated. When the STEP WRITE key is pressed, the error display (WRONG QUANTIZE!) will appear on the liquid crystal display for about two seconds, and the RX-15 will return to the SELECT PATTERN display. Be sure change the QUANTIZE data setting.

Each time the STEP WRITE key is pressed, the steps will cycle in the order of step 1 -- step 2 -- step 3 -- step 1.

The data write stage (step 4) can be entered by pressing the START button as long as you are on any step between 1 -- 3.

If you are on any step between 1 -- 4, pressing the STOP/CONTINUE button will disable the STEP WRITE function and return the RX-15 to the SELECT PATTERN display.

Step 1. Setting the number of beats within each measure  
This determines the number of beats (time signature numerator) within each measure.

The time signature display (STEP W. dd0/ee) will appear on the liquid crystal display (dd is the beat number data).

The basic data for a new PATTERN is 4 beats. (STEP W. 040/4) will appear on the liquid crystal display.

The number of beats is set by using the numerical markings on the NUMBER keys. The effective data range is from 01 (1 beat per measure) to 99 (99 beats per measure).

Entering 00 results in an error. You cannot progress from that point unless another number is entered.

Step 2. Setting the length of each beat  
This enables you to select the note length of each beat (Denominator of time signature: Quarter note J, Eighth note J, Sixteenth note J, etc.).

The time signature display (STEP W. dd/ee0) will appear on the liquid crystal display (/ee is the type of note. Note that the cursor has shifted).

The basic data for a new PATTERN is 4 beats. (STEP T.W. 040/4) will appear on the liquid crystal display.

The type of note to be entered can be selected by using the fraction markings on the NUMBER keys. You can select from 1/4 (quarter note) -- 1/32 (32nd note).

If 1/48 or 1/192 is entered, the RX-15 will ignore the command.

#### Step 3. Setting the number of measures

The length of each PATTERN will be determined by the number of measures (BAR).

The bar number display (STEP W. ff0 BAR) will appear on the liquid crystal display (ff represents the bar number).

The basic data for a new PATTERN is one bar. (STEP W. 010bar) will appear in the display.

The bar number is entered by using the numerical marking on the NUMBER keys. The effective data range is from 01 (1 bar) to 99 (99 bars).

Entering 00 results in an error. You cannot progress from that point unless another number is entered.

#### Step 4. Writing in data

The RX-15 will now shift to the DATA WRITE IN mode when the START button is pressed. The notes can be written in by using the INSTRUMENT buttons (Fig. 23). However, notice that once even a single note has been written in, the time signature and bar number can no longer be changed (step 1 -- 3).

The WRITE display (BAR ff: BEAT gg) will appear on the liquid crystal display. ff is the bar count, and gg is the note count within the bar.

The BEAT (note count) will progress according to the notes determined by the QUANTIZE function. Note that this is not the denominator of the time signature set in step 1.

Pressing the INSTRUMENT buttons will write in the notes for the corresponding instruments and advance the BEAT by 1 each.

Pressing the +1/YES button will advance only the BEAT without writing in any notes.

The PATTERN will return to the beginning after exceeding the bar number set in step 3. Additional notes can be written in while listening to the notes previously entered.

When a multiple number of INSTRUMENT buttons are pressed simultaneously, since each will be viewed as one note, BEAT will advance by as many INSTRUMENT buttons as were pressed. therefore when it is desired to use a multiple number of instruments on the same note, allow the PATTERN to cycle once and enter the additional notes on each succeeding cycle.

Pressing the INSTRUMENT buttons while holding down the ACCENT button will write in accented notes according to the ACCENT LEVEL set.

Notes can be erased simply by holding down the CLEAR key and pressing the corresponding INSTRUMENT button.

It is efficient to program a PATTERN by disabling the STEP WRITE function for the notes and instruments as required, changing the QUANTIZE data, and using the WRITE ADDITION/CORRECTION-MODIFICATION function of Step II-3.

Use the PATTERN DIAGRAM at the end of this text as a STEP WRITE memorandum.

The SWING function cannot be used for STEP WRITE.

Fig 23 Example: Writing in with STEP WRITE

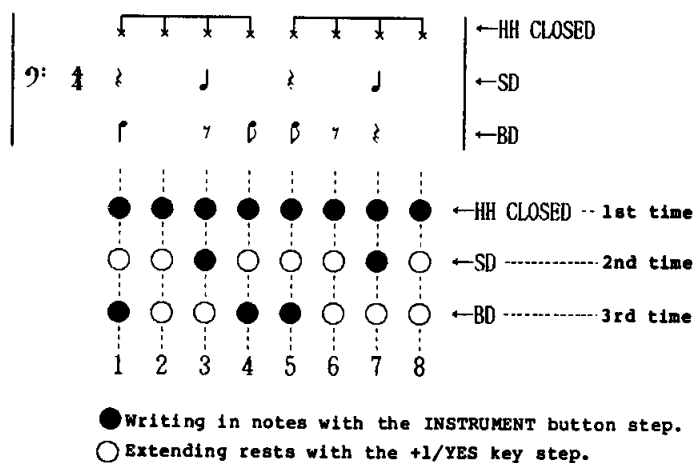

#### II: Modification of an existing PATTERN

Notes can be added and corrections can be made to a PATTERN that has already been programmed. However, the time signature and bar number cannot be corrected. There are three main operating steps, which are Step 1: Checking the time signature, Step 2: Checking the bar count, and Step 3: Adding and correcting notes.

Step 1 (checking the time signature) can be activated by pressing the STEP TIME WRITE key during the SLECT PATTERN display, or while the respective function of the SWING, QUANTIZE, CLICK, and TEMPO modes are activated.

Step 1 (checking the time signature) and Step 2 (checking the bar count) will be alternately activated each time the STEP TIME WRITE key is pressed.

During either Step 1 or Step 2, pressing the START key will cause the function to shift to Step 3 (data addition and correction).

During Step 1, Step 2 or Step 3, pressing the STOP/CONTINUE button will cancel the STEP TIME WRITE function and return the RX-15 to the SELECT PATTERN display.

The STEP WRITE function can also be used for PATTERNS that have been written in using the REAL TIME WRITE function.

**Step 1: Checking the time signature**

This function allows confirmation of time signature data set when the rhythm was entered.

The time signature display (STEP W. dd/ee) will appear. The cursor (0) will flicker over the S at the beginning of the display. dd/ee represents the time signature (dd stands for the number of beats within the bar, and ee represents the note length of each beat).

The time signature data cannot be changed, even by pressing the NUMBER keys.

**Step 2: Checking the bar count**

This function enables confirmation of the bar count data set when the rhythm was entered.

The bar count display (STEP W. ff BAR) will appear. The cursor (0) will flicker over the S at the beginning of the display. ff stands for the number of bars.

The bar count data cannot be changed, even by pressing the NUMBER keys.

**Step 3: Adding and correcting notes**

The INSTRUMENT buttons can be used to add notes after first activating the WRITE display by pressing the START button.

The contents of the function are identical to those for Step I-4: Writing in data (notes)

The data additions and corrections can also be carried out by using the REAL TIME WRITE function.

Operation procedure (Fig. 24)

a) Activate the SELECT PATTERN display and designate the

PATTERN number.

b) Press the STEP WRITE key and activate the time signature display (step 1).

c) Using the NUMBER keys, enter the number of beats per measure.

d) Press the STEP WRITE key and activate the time signature display (step 2).

e) Enter the type of note by using the NUMBER key.

f) Press the STEP WRITE key and activate the bar number display (step 3).

g) Enter the bar number by using the NUMBER keys.

\*\* Steps c), e) and g) can not be used with a finished PATTERN.

h) Press the START button and activate the WRITE display (step 4).

i) Enter the notes by using the INSTRUMENT buttons and the +1/YES button.

j) After you have finished writing in the data, press the STEP WRITE key to indicate the end and return to the SELECT PATTERN display.

k) Pressing the START button will play back the programmed PATTERN.

l) Playback can be stopped by pressing the STOP/CONTINUE button. Additionally, you can return to the SELECT PATTERN display by pressing the PATTERN/SONG switch.

m) Activate the different functions by using the STEP WRITE key if required, adding and correcting data as needed.

**Fig 24 STEP WRITE Function Operating Procedure**

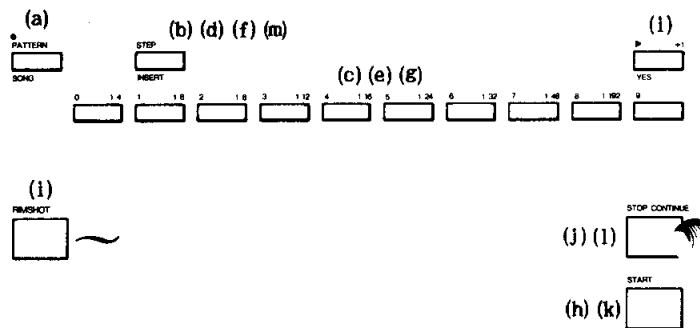

**Section 3-4 -- COPY**

This function includes COPY and CONNECT. There are 4 steps in this procedure, which are Step 1: Selecting the PATTERN to be copied, Step 2: Selecting the connecting PATTERN, Step 3: Selecting the PATTERN to be copied to, and Step 4: Executing the selected function. COPY and CONNECT are differentiated by the data entry of Step 2.

The COPY function consists of copying a certain PATTERN onto a separate PATTERN number.

The CONNECT function consists of connecting a certain PATTERN to a separate PATTERN. PATTERNS with differing time signature numerators can also be connected.

Pressing the COPY key during the SELECT PATTERN display or during the PATTERN PLAYBACK STOP mode will activate the COPY function.

Even while the respective functions of the SWING, QUANTIZE, CLICK, CLEAR and TEMPO modes are activated, the COPY function can be activated directly by pressing the COPY key.

Activating the COPY mode will cause the COPY display (COPY \*\*0+\*\*=\*\*) to appear. \*\* represents the PATTERN number. The PATTERN number to be copied is entered into the first two asterisk spaces (before the +), the connecting PATTERN number is entered into the middle two asterisk spaces (between the + and =), and the PATTERN number to be copied is entered into the last two asterisk spaces (after =).

The PATTERN number is entered by using the numerical markings on the NUMBER keys.

These steps will change in the order of 1 -- 2 -- 3 -- 4 -- each time the COPY key is pressed.

The functions for Steps 1 - 3 are quite similar. Notice that the position of the cursor (0) will shift.

When copying a certain PATTERN onto a separate PATTERN number, skip the connection PATTERN selection process (step 2).

When connecting a certain PATTERN following a separate PATTERN and writing the combined pattern onto a new PATTERN number, each step of the process must be carried out (Step 1 -- 2 -- 3 -- 4).

#### Step 1. Selecting the PATTERN to be copied

The display before entering the PATTERN number is (COPY \*\*0+\*\* = \*\*), which will change to (COPY aa0+\*\* = \*\*) after the PATTERN number has been entered (aa is the PATTERN number to be copied).

If the COPY key is pressed without entering a PATTERN number, the function will be cancelled and the RX-15 will return to the SELECT PATTERN display.

#### Step 2. Selecting the PATTERN to be connected to

The display before entering the PATTERN number is (COPY aa +\*\*0=\*\*) which will change to (COPY aa + bb0=\*\*) after the PATTERN number has been entered (bb is the connecting PATTERN.)

When only copying a PATTERN, shift to Step 3 by pressing the COPY key without entering any PATTERN number.

#### Step 3. Selecting the PATTERN to be copied to

The display before entering the PATTERN number is (COPY aa +bb =\*\*0) which will change to (COPY aa +bb = cc0) after the PATTERN number has been entered (cc is the PATTERN number to be copied to.)

Designating a PATTERN number that has already been programmed means erasing that PATTERN and replacing it with new PATTERN data. Especially when the memory is full due to COPY operations, memory errors can occur which can affect PATTERN data that has already been programmed. It is therefore recommended to designate a blank PATTERN when the remaining memory space is approaching its limits.

Pressing the COPY key without entering a PATTERN number will cancel the COPY function, and return the RX-15 to the SELECT PATTERN display.

#### Step 4. Execution of functions

Pressing the COPY key will memorize the PATTERNs selected in Steps 1 and 2 onto the PATTERN number designated in Step 3.

When the PATTERN number selected in Step 3 is that of a blank PATTERN, pressing the COPY button will cause the execution display to appear for about two seconds, after which time the RX-15 will return to the SELECT PATTERN display.

The execution display when the COPY function (Step 2 bypassed) is being executed is (COPY EXECUTING).

The execution display when the CONNECT function (Step 1 - 3) is being executed is (APPEND EXECUTING).

When the PATTERN number designated in Step 3 already contains note data, pressing the COPY button will cause the execution confirmation display (REWRITE PTN cc0?), to appear. (cc represents the PATTERN number to be copied to selected in Step 3.) This is a prompt that means: "Should PATTERN cc be rewritten?"

Answer the execution confirmation display by using the +1/YES and -1/ keys.

Entering YES will execute the functions and cause the execution display to appear for about two seconds, after which time the RX-15 will return to the SELECT PATTERN display.

Entering NO will cancel the functions and cause the RX-15 to return to the SELECT PATTERN display.

When the denominator of the time signature of PATTERN aa (PATTERN to be copied, selected in Step 1) differs from that of PATTERN bb (connecting PATTERN, selected in Step 2), the

COPY functions will not operate if both PATTERNS put together exceed 100 bars in length. If the execution of the functions is designated, the COPY functions will be cancelled, and the error display (WRONG SIGNATURE!) will be displayed for about two seconds, after which time the RX-15 will return to the SELECT PATTERN display.

Operation procedure (Fig. 25)

- a) Activate the SELECT PATTERN display.
- b) Pressing the COPY key, activate the selection step for the PATTERN to be copied.
- c) Using the NUMBER keys, enter the PATTERN number to be copied.
- d) Pressing the COPY key, shift to the connecting PATTERN selection step.
- e) Using the NUMBER keys, enter the number of the connecting PATTERN.
- \* When only copying a PATTERN, do not enter a PATTERN number.
- f) Pressing the COPY key, shift to the selection step for the PATTERN to be copied to.
- g) Using the NUMBER keys, enter the number of the PATTERN to be copied to.
- h) Press the COPY key once more to execute the operation. The execution display will appear for about 2 seconds, after which time the RX-15 will return the SELECT PATTERN display.

When the PATTERN number to be copied to already contains rhythm data, the execution confirmation display will appear. If execution of the operation is designated, by pressing the +1/YES key the execution display will appear for about 2 seconds, after which time the RX-15 will return to the SELECT PATTERN display.

**Fig 25 COPY Function Operating Procedure**

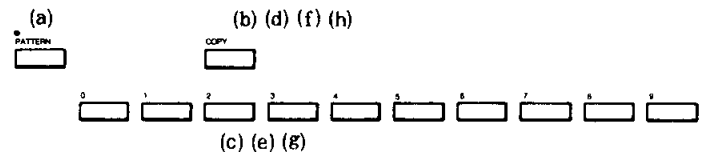

**Section 3-5 -- SWING**

This function programs and reproduces 4-beat jazz rhythm patterns. By delaying the timing (determined by the QUANTIZE function) of the even numbered notes (2, 4, 6), this achieves a subtle swing feeling that cannot be achieved by using the QUANTIZE function alone.

The SWING function is a supplement to the QUANTIZE function, and can be programmed independently for each PATTERN. It is also possible to program the SWING function to operate only on specific instruments and passages within each PATTERN.

The SWING function can be programmed only during the REAL TIME WRITE mode. The SWING data will be ignored if the notes are entered during the STEP WRITE mode.

The SWING function will operate only when the QUANTIZE data is 1/8 or 1/16. If SWING data is entered when the QUANTIZE data is 1/4, 1/6, 1/12, 1/24 or 1/32 -- 1/192, the error display (WRONG QUANTIZE!) will appear when the REAL TIME WRITE function is activated. In this case, it will be necessary to reset the QUANTIZE data.

The SWING function can be activated during the SELECT PATTERN display or during the PLAYBACK STOP mode by pressing the SWING key.

Even while the respective functions of the QUANTIZE, CLICK and TEMPO modes are activated, the SWING function can be activated directly by pressing the SWING key.

When the SWING function is activated, the SWING display (SWING LEVEL 0%) will appear. (0% is the SWING data. The data from the previous time will be displayed.)

The data ranges in six stages from 50 (OFF)/54/58/63/67/71%. Multiplying the length of the notes set by the QUANTIZE function by 2 and taking this as 100, this represents the timing of the even numbered notes compared to the odd numbered notes. (Fig. 26)

Select the data by using the +1/YES AND -1/NO keys.

Pressing the SWING key once again will disengage the SWING function and return the RX-15 to the SELECT PATTERN display.

**Fig 26 Delaying the Timing of Even-numbered Notes with SWING**

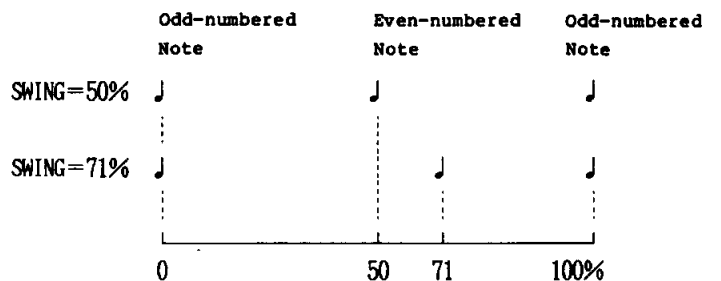

Operation procedure (Fig. 27)

- a) Activate the SELECT PATTERN display.
- b) Press the SWING key and activate the SWING display.
- c) Enter the data by using the +1/YES and -1/NO keys.
- d) Press the SWING key once again to complete the operation and return the RX-15 to the SELECT PATTERN display.

Fig 27 SWING Function Operating Procedure



Section 3-6 QUANTIZE

This function determines the length of the minimum unit notes used in programming PATTERNS. It also operates as the REAL TIME WRITE timing correction function.

The QUANTIZE function can be activated during the SELECT PATTERN display or during the PLAYBACK STOP mode by pressing the QUANTIZE key.

Even while the respective functions of the SWING, CLICK and TEMPO modes are activated, the QUANTIZE function can be activated directly by pressing the QUANTIZE key.

Activating the QUANTIZE function will cause the QUANTIZE display (QUANTIZE = 1/qg0) to appear. 1/qg is the QUANTIZE data. The data from the previous time will be displayed.

Enter the data by using the fraction markings on the NUMBER keys. The fractions represent the length of each note. The data range is from 1/4 (quarter notes) to 1/192 (192nd notes).

1/192 signifies that the QUANTIZE function (note length designation) is not being used, and that the timing definition of the RX-15 is being used to its maximum capacity. Therefore, (QUANTIZE =OFF) will be displayed.

Note that for REAL TIME WRITE and STEP WRITE, regardless of the time signature denominator (BEAT number) set by these functions, writing in data will be carried out using the notes determined by the QUANTIZE function as the units of measurement.

During the REAL TIME WRITE mode, pressing the INSTRUMENT button will enable the notes to be written in and changed to the note timing determined by the QUANTIZE function. For instruments that are primarily concerned with simply keeping the time, such as the cymbals (CYMBAL), this can be achieved simply by repeatedly pressing the corresponding INSTRUMENT

button. When it is desired to enter specific notes on a specific part, for FILL IN, for example, the QUANTIZE function will compensate for up to a 50% deviation (compared to the length of the note) in the pressing of the INSTRUMENT button.

During STEP WRITE, it is recommended to enter the data beginning with the coarser QUANTIZE data notes. If the data is entered from the finer QUANTIZE data notes, when the coarser QUANTIZE data are entered, it will not be possible to monitor the notes that were entered earlier in some cases. (Note however, that since the note data is being memorized, this will not affect the PATTERN playback.)

During the STEP WRITE mode, when combining the QUANTIZE function of 4-beat notes (1/4, 1/8, 1/16, etc.) together with that of 3-beat notes (1/6, 1/12, 1/24, etc.) it will not be possible to monitor the notes that were entered earlier in some cases.

Operation procedure (Fig. 28)

- a) Activate the SELECT PATTERN display.
- b) Press the QUANTIZE key and activate the QUANTIZE display.
- c) Use the NUMBER keys to enter the QUANTIZE data.
- d) Press the QUANTIZE key once again to complete the operation and return the RX-15 to the SELECT PATTERN display.

Fig 28 QUANTIZE Function Operating Procedure

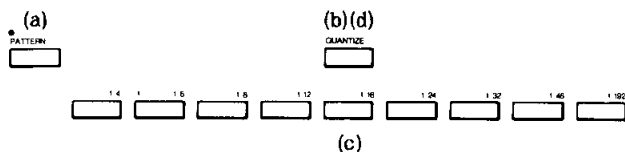

Using the QUANTIZE function

It is more practical to program a complex PATTERN by changing the QUANTIZE data for each instrument or note. (Repeat QUANTIZE - WRITE - QUANTIZE - WRITE.)

Deleting the number of rest notes entries required

The number of rest note entries can be held to a minimum by switching the QUANTIZE data according to the note length of each instrument during STEP WRITE.

For example, when creating a 16-beat rhythm pattern, use 1/8 to write in snare drum and bass drum parts, and use 1/16 only for the cymbals (Fig. 29).

Fig 29 Minimizing Rest Inputting: 16 Beats

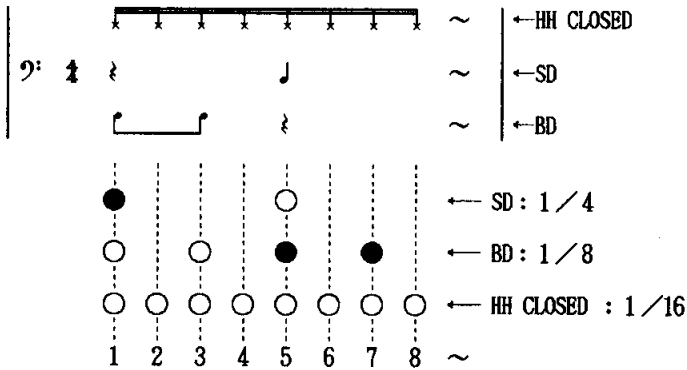

goes off, the rhythm will fall apart. Using a larger QUANTIZE data setting for the cymbals and bass drum, use the correction function to achieve perfect rhythm timing.

The snare drums and tom-toms are instruments that often exhibit subtle changes in timing. Use a finer QUANTIZE data setting to achieve minute deviations.

For example, to make an 8 beat rhythm pattern with a heavy down beat, use a 1/8 setting when entering the cymbals and bass drum data, and use a 1/192 setting to enter the snare drum data (Fig. 31).

Fig 31 Expressing a subtle driving feeling?????: 8 beats Delay

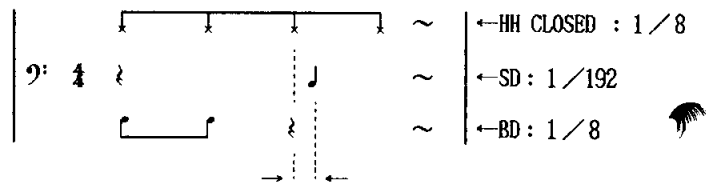

Complex patterns (REAL TIME WRITE and STEP WRITE)

When creating complex fill-ins and polyrhythms during the REAL TIME WRITE or STEP WRITE mode, the data entry can be simplified by changing the QUANTIZE data only for the sections required.

For example, when adding 2-beat triplet fill-ins (snare drum) to an 8-beat PATTERN, enter only the 2-beat triplet fill-ins with the QUANTIZE data set to 1/12, and enter the rest with the QUANTIZE data set to 1/8 (REAL TIME WRITE) or 1/24 (STEP WRITE). (FIG. 30)

Fig 30 Adding Polyrhythms and Fill-ins: a 2-beat Triplet

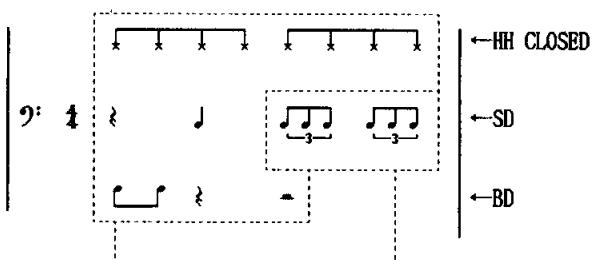

Inputting with QUANTIZE at 1/8 Inputting with QUANTIZE at 1/12

Subtle changes in the beat

By switching the QUANTIZE data for each instrument during REAL TIME WRITE, it is very easy to program rhythm patterns that have a natural, "live" feel.

The cymbals and the bass drum are instruments that are primarily concerned with keeping the rhythm. If the timing

If the SD timing is delayed, a heavy downbeat can be expressed.

Section 3-7 -- CLICK

This function determines the number of beats of the rhythm guide that will sound during REAL TIME WRITE.

The CLICK function can be activated during the SELECT PATTERN display or during the PATTERN PLAYBACK STOP mode by pressing the CLICK key.

Even while the respective functions of the SWING, QUANTIZE and TEMPO modes are activated, the CLICK function can be activated directly by pressing the CLICK key.

Activating the CLICK function will cause the CLICK display (CLICK =1/cc0) to appear. 1/cc is the CLICK data. The data from the previous time will be displayed.

Enter the data by using the fraction markings on the NUMBER keys. Each fraction indicates the length of the notes. The effective data range is from 1/4 (quarter notes) - 1/32 (32nd notes).

1/48 and 1/192 setting result in an error. The RX-15 will ignore this command.

The rhythm guide can be activated by pressing the START switch during the REAL TIME WRITE function. The RX-15 will enter the WRITE mode and the rhythm guide will begin to sound. Set the volume by using the DATA ENTRY SLIDER.



The rhythm guide beat that corresponds to the beginning of the bar will be accented.

The rhythm guide will be set regardless of the time signature denominator (beat number, set with the REAL TIME WRITE function). Note that if the rhythm guide setting does not match that of the desired rhythm, you will most probably loose track of the rhythm.

Operation procedure (Fig. 32)

- a) Activate the SELECT PATTERN display.
- b) Activate the CLICK display by pressing the CLICK key.
- c) Enter the CLICK data by using the NUMBER keys.
- d) Press the CLICK key once again to complete the operation and return the RX-15 to PATTERN display.

**Fig 32 CLICK Function Operating Procedure**



**Section 3-8 -- CLEAR**

This function will erase individual and multiple PATTERNS and notes. It has five functions which are outlined in the five steps below. Step 1 will clear individual PATTERNS, Step 2 will clear individual instruments, Steps 3 and 4 will clear individual notes, and Step 5 will clear all patterns. Please note that the operation procedure is different for each.

**Step 1. Clearing individual PATTERNS (CLEAR PATTERN)**

This function will clear individual PATTERNS.

The CLEAR function can be activated by pressing the CLEAR key during the SELECT PATTERN display or during the PATTERN PLAYBACK STOP mode.

Even while the respective functions of the SWING, QUANTIZE, CLICK and TEMPO modes are activated, the CLEAR function can be activated directly by pressing the CLEAR key.

Select the PATTERN number to be cleared during the SELECT PATTERN display. The PATTERN number cannot be changed once the CLEAR function is activated.

Activating the CLEAR function will cause the CLEAR display (CLEAR PTn pp?) to appear. (The cursor 0 will flicker over the ? on the display.) This is a prompt asking "Should PATTERN pp be cleared?".

Answer the prompt by using the +1/YES or -1/NO keys.

Entering YES will cause the PATTERN to be cleared. After approximately two seconds time, during which (PTN 00 CLEARED !) will be displayed, the RX-15 will automatically return to the SELECT PATTERN display.

Entering NO will cancel the function, and the RX-15 will return to the SELECT PATTERN display.

When the PATTERN to be erased does not contain any data, the RX-15 will bypass the execution display and will return directly to the SELECT PATTERN display.

Operation procedure (Fig. 33)

- (a) Activate the SELECT PATTERN display.
- (b) Designate the PATTERN number to be cleared by using the NUMBER keys.
- (c) Activate the CLEAR PATTERN display by pressing the CLEAR key.
- (d) After the pattern has been cleared by pressing the +1/YES, the RX-15 will automatically return to the SELECT PATTERN display.

**Fig 33 CLEAR PATTERN Operating Procedure**

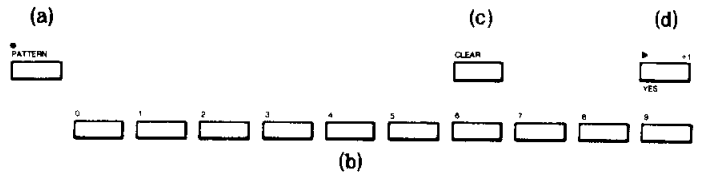

**Step 2. Clearing individual instrument parts (CLEAR INSTRUMENT)**

This function will clear the part of a certain specified instrument within a certain PATTERN.

Pressing one of the INSTRUMENT buttons during the CLEAR PATTERN display of step 1 will activate the CLEAR INSTRUMENT function for that particular instrument.

The CLEAR INSTRUMENT display (CLEAR PTpp XXXX?) is a user prompt that means (Should instrument XXXX of PATTERN pp be cleared?). The cursor will flicker over the ? on the display.

Answer the prompt by using either the +1/YES key or -1/NO key.

Pressing the YES key will clear the instrument's part. After approximately two seconds, during which time (XXXX 0 CLEARED!) will be displayed, the RX-15 will automatically return to the SELECT PATTERN display.

Entering NO will cancel the function and return the RX-15 to the SELECT PATTERN display.

Operation procedure (Fig. 34)

- (a) Activate the SELECT PATTERN display.
- (b) Select the PATTERN by using the NUMBER keys.
- (c) Activate the CLEAR PATTERN display by pressing the CLEAR key.
- (d) Activate the CLEAR INSTRUMENT display by pressing the INSTRUMENT button of the instrument to be cleared.
- (e) After the instrument's part has erased by pressing the +1/YES key, the RX-15 will automatically return to the SELECT PATTERN display.

**Fig 34 CLEAR INSTRUMENT Operating Procedure**

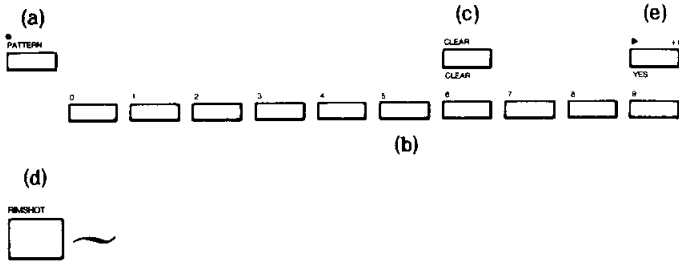

**Step 3. Clearing notes during REAL TIME WRITE (REAL TIME CLEAR)**

This enables you to clear certain specific notes by utilizing the REAL TIME WRITE function.

The desired instrument's part can be erased by holding down the CLEAR key and pressing the desired INSTRUMENT button during the WRITE mode of the REAL TIME WRITE function.

Press the INSTRUMENT button so that the timing matches that of the note to be cleared. However, the note will sound on the particular cycle. Listen to the note on the next cycle to determine whether it has been successfully cleared or not.

The WRITE display (REAL T.W.PTN pp) will not change, even if the CLEAR key is pressed.

If it is desired to clear more than one note, hold down the CLEAR key and the desired INSTRUMENT button.

It is also possible to clear multiple instruments at the same time.

Notes for which the timing of the QUANTIZE data or SWING data does not match during CLEARING will not be cleared. All notes can be cleared by setting the QUANTIZE data to 1/192 (OFF).

Operation procedure (Fig. 35)

- (a) Activate the SELECT PATTERN display.
- (b) Select the PATTERN by using the NUMBER keys.
- (c) Activate the REAL TIME WRITE function by pressing the REAL TIME WRITE key.
- (d) Activate the WRITE display by pressing the START button.
- (e) While holding down the CLEAR key, press the corresponding INSTRUMENT button so that the timing matches that of the note to be cleared.
- (f) Press the STOP/CONTINUE button to return the RX-15 to the SELECT PATTERN display.

**Fig 35 REAL TIME CLEAR Operating Procedure**

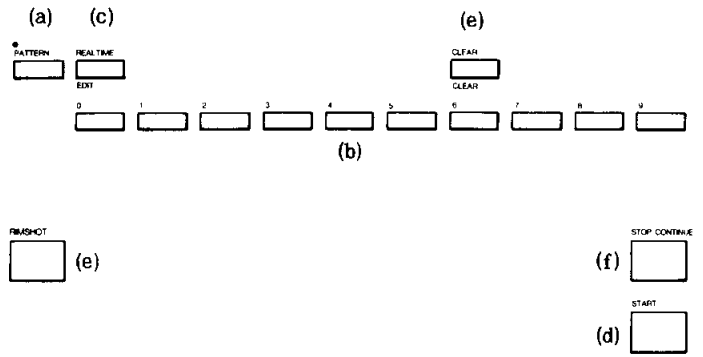

**Step 4. Clearing notes during STEP WRITE (STEP CLEAR NOTE)**

Specific notes can be cleared by utilizing the STEP WRITE function.

During the WRITE mode of the STEP WRITE function, the desired notes can be cleared by pressing the corresponding instrument button while holding down the CLEAR key.

Move to the position of the note to be cleared by using the +1/YES key. The note can then be cleared by pressing the corresponding INSTRUMENT button while holding down the CLEAR key. The note count nn of the WRITE display (BAR mm 0:BEAT nn) will advance by one count.

When a note is being cleared, the instrument will not sound when the INSTRUMENT button is pressed.

Notes for which the timing of the QUANTIZE data does not match during CLEARING will not be cleared (neither will they sound). Reset the QUANTIZE data to correspond correctly with the notes to be cleared.

- (a) Activate the SELECT PATTERN display.
- (b) Select the PATTERN by using the NUMBER keys.
- (c) Activate the STEP WRITE function by pressing the STEP WRITE key.
- (d) Activate the WRITE display by pressing the START button.
- (e) Advance to the note count of the note to be cleared by using the +1/YES key.
- (f) Erase the note by pressing the INSTRUMENT button while holding down the CLEAR key.
- (g) Press the STOP/CONTINUE button and return the RX-15 to the SELECT PATTERN display.

Fig 36 STEP CLEAR Operating Procedure

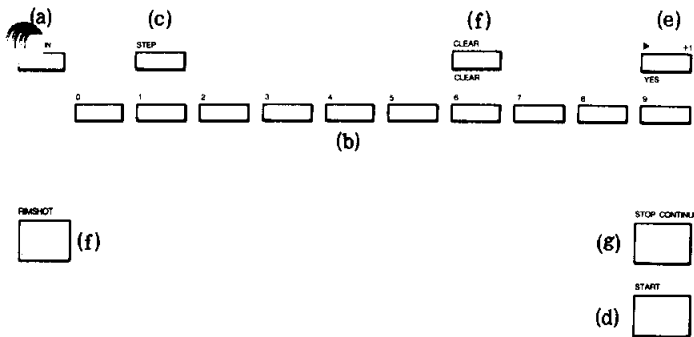

Step 5. Clearing all PATTERNS (CLEAR ALL PATTERN)

This feature will clear every PATTERN and will also initialize the memory.

This is a double function of the ACCENT button and the STOP/CONTINUE button.

During the CLEAR PATTERN display, if the ACCENT button and STOP/CONTINUE buttons are pressed simultaneously, the confirmation message "CLEAR ALL PTNS?" appears. When the +1/YES key is pressed at this time, ALL CLEAR is executed. After about two seconds, the message "ALL PTNS CLEAR!" is displayed, and the RX-15 will return to the SELECT PATTERN display.

If the software of the RX-15 becomes uncontrollable due to an operation error, this feature is highly useful in correcting the operation.

To protect against losing valuable data, before carrying out the CLEAR ALL function or the RAM initialization function, be sure to use the SAVE function of the FUNCTION mode and copy the data onto a cassette tape.

- (a) Activate the SELECT PATTERN display.
  - \* There is no need to enter the PATTERN number.
- (b) Activate the CLEAR PATTERN display by pressing the CLEAR key.
- (c) A confirmation display will appear when the ACCENT button and STOP/CONTINUE buttons are pressed simultaneously.
- (d) When the +1/YES key is pressed, ALL CLEAR is executed. The RX-15 will then automatically return to SELECT PATTERN display.

Fig 37 PATTERN ALL CLEAR Operating Procedure

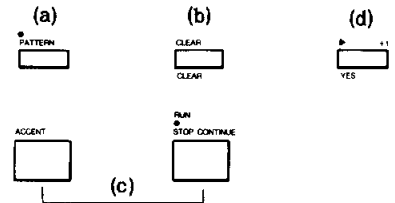

Section 3-9 -- TEMPO

This function determines the tempo. It can also be used to confirm the tempo set with the TEMPO SLIDER. This is a mutual function of the PATTERN mode and the SONG mode.

The TEMPO function can be activated by pressing the TEMPO key during the SELECT PATTERN display, or the SELECT SONG display.

Even during PATTERN PLAYBACK, SONG PLAYBACK and PLAYBACK STOP, the TEMPO function can be activated directly by pressing the TEMPO key.

Activating the TEMPO function will cause the TEMPO display (TEMPO J=ttt) to appear (ttt is the data). This display indicates the number of quarter notes per minute.

Data can be entered either by using the +1/YES and -1/NO keys or the TEMPO SLIDER. The TEMPO data will shift at high speed if the +1/YES and -1/NO keys are held down.

When the data is entered by using the +1/YES and -1/NO keys, regardless of the position of the TEMPO SLIDER, fine adjustments to the tempo in one beat increments are possible. The upper limit of the data range will also increase, extending from 40 (quarter note=40) - 250 (quarter note = 250). However, if the TEMPO SLIDER is moved even minutely, the tempo will change according to the position of the TEMPO SLIDER.

When the data is entered by using the TEMPO SLIDER, coarse adjustments to the tempo can be made in three beat increments over a range of 40 - 166 beats per minute, and in four beat increments over a range of 166 - 250 beats per minute.

Pressing the TEMPO key once again will return the RX-15 to the SELECT PATTERN display or the SELECT SONG display.

Operation procedure (Fig. 33)

- (a) Activate the SELECT PATTERN display or the SELECT SONG display.
- (b) Activate the TEMPO display by pressing the TEMPO key.
- (c) Enter the tempo data by using either the +1/YES and -1/NO keys or the TEMPO SLIDER.
- (d) Press the TEMPO key once again to cancel the TEMPO and return the RX-15 to either the SELECT PATTERN display or the SELECT SONG display.

**Fig 38 TEMPO Operating Procedure**



**Section 3-10 -- PLAY PATTERN**

This function will playback PATTERNS that have been programmed. Pressing the START button will cause playback to commence.

If the START button is pressed during the SELECT PATTERN display, the RX-15 will enter the PLAYBACK mode and playback of the desired PATTERN will commence.

Even during the respective functions of the SWING, QUANTIZE, CLICK and TEMPO modes, the PLAY PATTERN can be activated directly by pressing the PLAY PATTERN key.

When PLAYBACK commences, the RUN indicator will light up and the PLAY PATTERN display (PLAY PTNpp: BRffC) will appear. pp represents the PATTERN number, BR represents the bar, and ff represents the bar count within the PATTERN that is being played back.

The same PATTERN will be played back repeatedly until the function is stopped.

PATTERN playback can be stopped by pressing the STOP/CONTINUE button. Pressing the STOP/CONTINUE button once again will cause playback to commence from the point where it was stopped. If the START button is pressed instead, the PATTERN will be played back from the very beginning.

If the PATTERN/SONG key, NUMBER keys, or +1/YES and -1/NO keys are pressed during the PLAYBACK STOP mode, the PLAYBACK mode will be cancelled. Pressing the PATTERN/SONG key will cause the RX-15 to return to the SELECT PATTERN display of the previous PATTERN, and pressing the NUMBER or +1/YES and -1/NO keys will shift the RX-15 to the SELECT PATTERN display of the PATTERN number selected.

If the NUMBER keys or +1/YES and -1/NO keys are pressed during the PLAYBACK of a certain PATTERN, the next PATTERN number to be played back can be programmed in the display so that the PLAYBACK will be continuous. For example, if PATTERN number qq is entered during the PLAYBACK of PATTERN pp, (PLAY PTNqq: BRff0) will appear in the display. After the PLAYBACK of PATTERN pp has finished, the RX-15 will automatically shift to the PLAYBACK of PATTERN qq so that the PLAYBACK is continuous.

Operation procedure (Fig. 39)

- (a) Activate the SELECT PATTERN display.
- (b) Use the NUMBER keys or +1/YES and -1/NO keys to designate the PATTERN number.
- (c) Press the START button to start PLAYBACK.
- (d) Press the STOP/CONTINUE to stop PLAYBACK.
- (e) Press the PATTERN/SONG KEY to end PLAYBACK.

The PLAYBACK mode can also be ended by pressing the NUMBER keys or the +1/YES and -1/NO keys.

**Fig 39 PATTERN Playback Procedure**

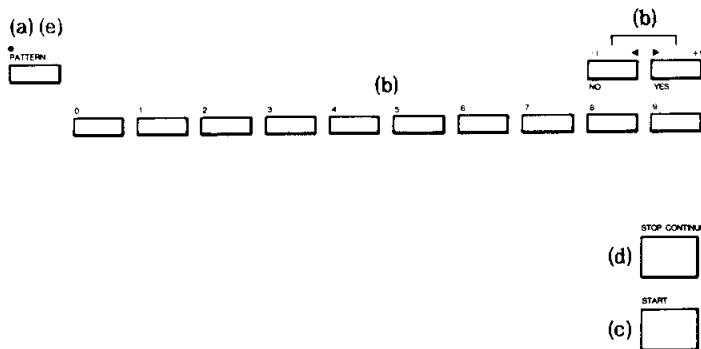

# Part 4: SONG MODE/

## Program For Constructing and Finishing Songs

The SONG mode is a function group that connects pre-programmed PATTERNS together to create the rhythm pattern for a single complete composition. The rhythm pattern for one complete song, made by connecting different PATTERNS together, is referred to as a "SONG". "PART" refers to SONG PARTS where PATTERNS can be inserted.

### Operation process for the SONG mode

In order to efficiently create one complete SONG, the order in which each function is used should be as follows:

- ☂  
1) Select a SONG number ..... 4-1: SELECT SONG
- (2) Construct a SONG by inserting different PATTERNS into the respective PARTS ..... 4-2: EDIT
- (3) Insert a PATTERN into the desired PART... 4-3: INSERT
- (4) Delete undesired PARTS ..... 4-4: DELETE
- (5) Designate "REPEAT" between desired PARTS 4-5: REPEAT
- (6) Determine TEMPO ..... 4-6: TEMPO
- (7) Change tempo after a specific PART ..... 4-7: TEMPO CHANGE
- ☂  
(8) Delete undesired SONG ..... 4-8: CLEAR
- (9) Playback a SONG ..... 4-9: PLAY SONG

### MEMORY FULL display

When the space remaining in the SONG memory bank approaches its limit, the MEMORY FULL display (SONG MEMORY FULL) will appear. Naturally, when the memory space has all been used up, it will not be possible to program SONGS. Delete SONG data that is not required and order the memory space efficiently.

The memory full display can appear when the respective functions of the EDIT, INSERT, REPEAT and TEMPO CHANGE modes have been activated.

When the memory space is thought to be approaching its limits, it is recommended to delete SONG data that is not required in order to use the memory space efficiently.

By using the SAVE function of the FUNCTION mode to copy the memory data onto an external cassette tape, the CLEAR function can then be used to open up the entire memory space without fear of losing any memory data.

### Section 4-1 SELECT SONG

It is necessary to select a SONG number in order to program, playback or erase the particular SONG. Designating the SONG number can be carried out by using the SELECT SONG display, which can be called by switching to the SONG mode.

When activating the SONG mode, first return to the SELECT PATTERN display, and then switch to the SONG mode by using the PATTERN/SONG key.

During the SELECT PATTERN display, pressing the PATTERN/SONG key will activate the SONG mode and cause the SELECT SONG display (SELECT SONG bb0) to appear. (bb is the SONG number called out on the previous time/fig. 40)

During the SELECT PATTERN display (SELECT PATTERN 00), which can be activated by turning on the power, if the RX-15 is switched to the SONG mode, SONG 00 will be selected and (SELECT SONG 000) will appear (Fig. 40).

Enter the SONG number by using the numerical markings on the NUMBER keys. A total of ten SONG numbers can be designated, from 00-09.

The cursor will disappear after the SONG number has been entered, and the display will change to (SELECT SONG ss0). (ss is the SONG NUMBER/fig. 40).

Fig 40 SELECT SONG Display

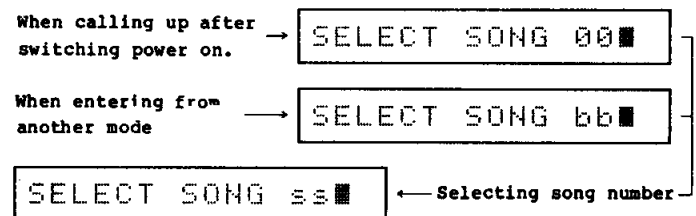

Pressing the NUMBER keys during the SONG PLAYBACK STOP mode will activate the SELECT SONG display for the number that was selected.

If the automatically selected SONG number is acceptable, the process of entering the SONG number can be skipped.

Operation procedure (Fig. 41)

- (a) Activate the SELECT SONG display.
- (b) Enter the SONG number by using the NUMBER keys.
- (c) When programming a SONG, carry out the operations following Section 4-2.

\* To PLAYBACK a SONG, carry out the operation of Section 4-9.

**Fig 41 SONG Selection Procedure**

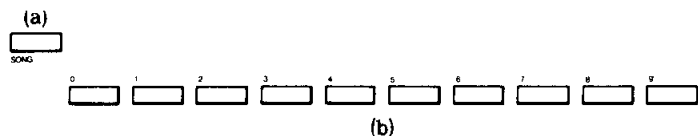

**Section 4-2 -- EDIT**

This function connects different PATTERNS together to create a total rhythm pattern for one complete composition. This EDIT operation (EDIT) selects different PATTERNS in order and inserts them into the respective PARTS of the SONG. The PATTERNS will be determined in order, from PART 001-255.

The EDIT function can be activated by pressing the EDIT key during the SELECT SONG display, SONG PLAYBACK STOP mode, or during the TEMPO function mode.

Activating the EDIT function will cause the PART display (PART 001=PTN \*\*) to appear. \*\* is the PATTERN number entry space.

Enter the PATTERN number by using the numerical markings on the NUMBER keys.

The PATTERNS can be designated from 00-99. the cursor (C) will appear after the number has been entered, and the display will change to (PART xxx = PTN pp0). (xxx is the PART number, and pp is the PATTERN number).

If the number of an empty PATTERN is selected, that PART will take the form of a one bar rest in 4/4 time.

The function will advance to the next PART each time the +1/YES key is pressed. However, when the PATTERN number has not been entered for a certain PART (displays \*\* for the PATTERN number), the function will not advance to the next PART, even if te +1/YES key is pressed.

Pressing the -1/NO key once will decrement the PART number by one.

Holding down the +1/YES AND -1/NO keys will cause the numbers to shift at high speed.

Pressing the EDIT key once again will cancel the EDIT function and return the RX-15 to the SELECT SONG display.

The PATTERN numbers can be corrected by activating the PART display for a pre-programmed SONG.

The four master functions of the EDIT function are INSERT, DELETE, REPEAT, and TEMPO CHANGE. These four functions all activated by utilizing the PART display of the EDIT function.

Operation procedure (Fig. 42)

- (a) Activate the SELECT SONG display.
- (b) Designate the SONG number by using the NUMBER keys.
- (c) Activate the PART display by pressing the EDIT key.
- (d) Enter the PATTERN number by using the NUMBER keys.
- (e) Advance the PART numbers by using the +1/YES key.
- (f) Repeat steps (d) and (e) for as many PARTS as required.
- (g) Use the -1/NO key to confirm PARTS that have already been programmed.
- (h) Press the EDIT key once again to cancel the EDIT function and return the RX-15 to the SELECT SONG display.

It is also possible to continue on from the PART display, and activate the INSERT, DELETE, REPEAT, and TEMPO CHANGE functions.

**Fig 42 EDIT Function Operating Procedure**

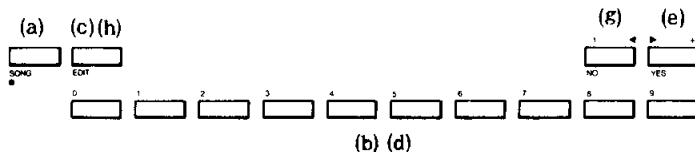

## Section 4-3 -- INSERT

This function enables the desired PATTERNS to be inserted into the desired PARTS of a song. This operation can be divided into two principle parts, that of designating the PART to be inserted (Step 1), and that of selecting the PATTERN where the desired PART will be inserted (Step 2).

The INSERT function can be activated by pressing the INSERT key during the PART display.

The INSERT function cannot be activated during the SELECT SONG display, even when the INSERT key is pressed.

After insertion has been carried out by using the INSERT function, the PATTERN data will shift and be rewritten for every PART that follows. Additionally, for REPEAT data within the PART display, the PART number corresponding to the beginning of the REPEAT symbol will also be automatically adjusted.

If the REPEAT data and the TEMPO CHANGE data of the PART display are activated, the INSERT function will not operate.

### Step 1. Selecting the INSERT PART

The PART selected during the PART display by using the +1/YES and -1/NO key will be located to the INSERT position set when the INSERT function was activated by pressing the INSERT key.

The INSERT function will be carried out between PART xx of the PART display (PART xxx=PTN pp) and PART immediately preceeding it.

Pressing the INSERT key will cause the INSERT confirmation display (INSERT PART xxx?) to appear. The cursor (C) will flicker over ? This is a prompt that indicates (Should an INSERT be carried out at PART xxx?).

Answer the prompt by using the +1/YES and -1/NO keys.

Enter YES will cause the INSERT function to shift to the INSERT PART display of Step 2.

Entering NO will cancel the INSERT function and return the RX-15 to the PART display.

### Step 2. Selecting the INSERT PATTERN

This designates the PATTERN number of the INSERT PATTERN display.

\*\* of the INSERT PART display (PART xxx=PTN \*\*C) is the INSERT PATTERN number entry space. (The cursor position differs from that of the PART display.)

Enter the PATTERN number by using the numerical markings on the NUMBER keys. The PATTERN can be selected as desired from 00 - 99.

The function will be executed and completed after the PATTERN number has been entered. The display will change to (PART xxx=PTN pp0). pp is the INSERT PATTERN number. This means that the RX-15 has returned to the normal PART display.

Pressing the -1/NO key without entering a PATTERN number will cancel the INSERT function.

When the number of an empty PATTERN has been selected, that PART will take the form of a one bar rest in 4/4 time.

### Operation procedure (Fig. 43)

- (a) Activate the SELECT SONG display.
- (b) Designate the SONG number by using the NUMBER keys.
- (c) Activate the PART display by using the EDIT key.
- (d) Select the INSERT position PART number by using the +1/YES and -1/NO keys.
- (e) Activate the INSERT confirmation display by pressing the INSERT key.
- (f) Designating YES by using the +1/YES key will cause the INSERT function to shift to the INSERT PART display.
- (g) Designating the PATTERN number by using the numerical markings on the NUMBER keys will execute and complete the INSERT operation and return the RX-15 to the normal PART display.

Fig 43 INSERT Function Operating Procedure

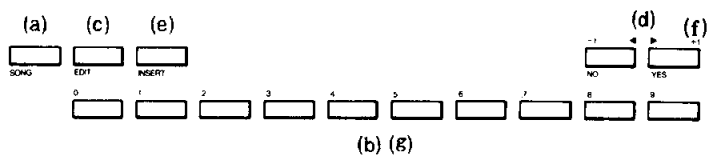

## Section 4-4 -- DELETE

This function will delete the undesired portions of a SONG. This can be divided into three main sub-functions: step 1: PART deletion, step 2: REPEAT data cancel, step 3: TEMPO CHANGE data cancel.

During the PART display, the PART number selected by using the +1/YES and -1/NO keys, the REPEAT data, and the TEMPO CHANGE data can be deleted.

The DELETE function can be activated by pressing the DELETE key during the PART display.

The DELETE function cannot be activated during the SELECT SONG display, even when the DELETE key is pressed.

Activating the DELETE function will cause the DELETE confirmation display (DELETE ..... 0?) to appear. This is a prompt that indicates "Should ..... be deleted?"

Answer the prompt by pressing the +1/YES and -1/NO keys.

Entering YES will cause the DELETE operation to be executed, and the RX-15 will return to the PART display.

Entering NO will cancel the DELETE function and return the RX-15 to the PART display.

#### Step 1. Deleting undesired PARTS

The PARTS xxx of the PART display (PART xxx=PTN pp) can be deleted.

The DELETE confirmation display (DELETE PART xxx?) will appear. The cursor (0) will appear over?

When a PART has been deleted by using the DELETE function, the PATTERN data will be shifted up and rewritten for all PARTS and REPEAT data that follow.

When a PATTERN number is DELETED, the corresponding REPEAT data and TEMPO CHANGE data will also be DELETED.

#### Step 2. Cancelling REPEAT data

By deleting the REPEAT data display (REPT for nn0 to mmm) portion of the PART display, the REPEAT designation for that section can be cancelled.

The DELETE confirmation display is (DELETE REPEAT ?).

#### Step 3 Cancel TEMPO CHANGE data

By deleting the TEMPO CHANGE data display (TEMPO IS uu UP) or (TEMPO IS uu DOWN) portion of the EDIT PART display, the TEMPO CHANGE designation for that section can be cancelled.

The DELETE confirmation display is (DELETE TMP C. ?).

#### Operation procedure (Fig. 44)

- (a) Activate the SELECT SONG display.
- (b) Designate the SONG number by using the NUMBER keys.
- (c) Activate the PART display by pressing the EDIT key.
- (d) Select the portion to be erased by using the +1/YES and -1/NO keys.
- (e) Activate the DELETE confirmation display by pressing the DELETE key.

(f) Pressing the +1/YES key will execute and complete the DELETE operation and return the RX-15 to the PART display.

Fig 44 DELETE Function Operating Procedure

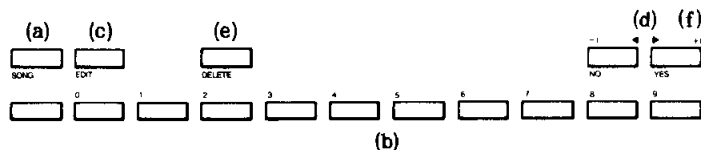

#### Section 4-5 -- REPEAT

This repeat function enables any desired area between specified PARTS to be played back repeatedly for up to a maximum of 100 times. The REPEAT function can be divided into the four following major operational steps; Step 1: Designating the PART number at the end of the section to be REPEATED, Step 2: Designating the PART number at the beginning of the section to be REPEATED, Step 3: Designating the number of repeats, and Step 4: Writing the data onto the PART display.

The function can be activated by pressing the REPEAT key during the PART display.

Since the REPEAT function deals with the playback of a song, it will be memorized with a different format than that of note data. Using the REPEAT function also helps to conserve the note data memory space. (Refer to Using the REPEAT function.)

The REPEAT function can be programmed for as many repeats as desired within a single SONG. Its principle application is to simplify the programming of complex SONGS. (Refer to Using the REPEAT function.)

#### Step 1. Designating the REPEAT end PART number

Select the PART that will be at the end of the REPEAT block by using the +1/YES and -1/NO keys during the PART display.

Pressing the REPEAT key will activate the REPEAT function, select the REPEAT end PART number, and shift the REPEAT function to the REPEAT PART display of Step 2.

This is the same as if the END REPEAT symbol (:||) was written in following PART xxx of the PART display (PART xxx = PTN pp).

#### Step 2. Designating a REPEAT beginning PART number

This function designates the REPEAT beginning PART number during the REPEAT PART display.



Enter the REPEAT beginning PART number onto the \*\*\* of the REPEAT PART display (GO TO PART \*\*\* ?).

Designate the PART number by using the numerical markings on the NUMBER keys.

The effective data range is from 001 to the PART number (=xxx) selected as the REPEAT end (:||).

When the data has been entered, the display will change to (GO to PART mmm). mmm is the PART number. This is the same as if the REPEAT beginning symbol (||:) was written in before PART mmm.

After entering the PART number, pressing the REPEAT key will cause the REPEAT function to shift to the REPEAT number display of Step 3.

000 is the cancel data. If 000 is entered and REPEAT is used, the REPEAT function will be cancelled and the RX-15 will return to the PART display.

Entering any number (yyy) larger than the REPEAT end PART number xxx will result in an error. If such a number is entered, the display will change to (GO to PART yyy?). Unless a number equal to or lower than xxx is entered, you cannot progress from that point.

### Step 3. Designating the REPEAT number

This designates the REPEAT number of the REPEAT number display.

The \*\* of the REPEAT number display (REP COUNTS \*\*0?) is the entry space of the REPEAT number.

Enter the REPEAT number by using the numerical markings on the NUMBER keys.

The effective data range is from 01 -- 99. (REP COUNTS nn) will appear on the display. (nn) is the REPEAT number data.

The REPEAT function will be executed and completed once the REPEAT number data has been entered. The RX-15 will then return to the PART display of PART xxx (REPEAT end) previous to the activation of the REPEAT function.

The first play is not included in the REPEAT number data nn. Therefore, the actual number of REPEATs will be the REPEAT number data plus 1.

Entering 000 cancels the REPEAT function. If 000 is entered and the REPEAT key is pressed, the REPEAT function will be cancelled and the RX-15 will return to the PART display.

### Step 4. Writing in REPEAT data onto the PART display

When a REPEAT command is designated, the REPEAT data will be written onto the PART display, the REPEAT function will be cancelled and the RX-15 will return to the PART display.

During the PART display, the REPEAT data will be written between the REPEAT end symbol PART and the PART following it.

The REPEAT data display is (REPT for nn0 to mmm), which means "Return to PART mmm and repeat nn times".

Deleting the REPEAT data display by using the DELETE function will cancel the REPEAT command for that particular section. DATA that has already been written in can not be changed.

### Operation procedure (Fig. 45)

- a) Activate the SELECT SONG display.
- b) Designate the SONG number by using the NUMBER keys.
- c) Activate the PART display by pressing the EDIT key.
- d) Select the PART number that corresponds to the REPEAT end symbol by using the +1/YES and -1/NO keys.
- e) Activate the REPEAT PART display by pressing the REPEAT key.
- f) Designate the PART number that corresponds to the REPEAT beginning symbol by using the NUMBER keys.
- g) Activate the REPEAT number display by pressing the REPEAT key.
- h) Designate the number of REPEATs by using the NUMBER keys.
- i) Pressing the REPEAT key once again will complete the REPEAT function and return the RX-15 to the PART display.

Fig 45 REPEAT Function Operating Procedure

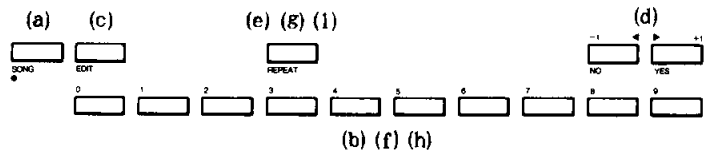

### Using the REPEAT Function

The REPEAT function can be used for conserving the note data space or for simplifying the programming of complex SONGS.

Deleting identical PATTERNS: conserving data space

For PATTERNS that are repeated within the same PART, the note data memory space can be conserved to a significant degree by programming in REPEAT commands.

When the REPEAT end PART number (PART xxx) is also designated as the REPEAT beginning PART number, only PART xxx will be repeated. This means that : PART xxx : is possible.

For example, normally to repeat PATTERN 01 six times during PART 001, and then shift to PART 002 equals PATTERN 02, the program would be 01 01 01 01 01 01 02.

However, by programming REPEAT commands, the program on the PART display can be abbreviated to

(PART 001 = PTN01) (REPT for 05 to 001)

(PART 002=PTN 02)

(Fig. 46)

Combining REPEAT commands: applications to complex SONGs

By combining REPEAT commands together, it is possible to create complex SONG rhythm progressions that would not be normally possible.

By entering a REPEAT command for a PART that already has a REPEAT command, the later REPEAT data will be entered on the outside of the previous REPEAT data (after the REPEAT end symbol and before the REPEAT beginning symbol). the combined REPEAT symbols will appear as (||: ||: :||: ||). This enables complex rhythm progressions using Da Capo and Dal Scenio, etc. to be easily programmed.

In Fig. 46, when a command to repeat from PART 002 to PART 001 would be

(PART 001=PTN 01) (REPT for 05 to 001)

(PART 002=PTN 02) (REPT for 01 to 001)

The REPEAT command entered later corresponds to a Da Capo command, and the resulting program would normally be

01 01 01 01 01 01 02 01 01 01 01 01 01 02

(Fig. 47)

For example, when combining different REPEAT commands, it also possible to program rhythm progressions using Dal Scenio. The following PART display

(PART 001=ptn 01)

(PART 002=ptn 02) (REPT for 01 to 001)

(PART 003=ptn 03) (REPT FOR 01 TO 002)

corresponds to a SONG progression of

01 02 01 02 03 02 01 02 03

(Fig. 48)

Fig 46 Abbreviating the same PATTERN with REPEAT

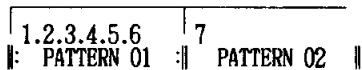
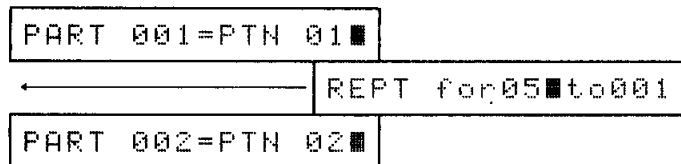

Fig 47 Example: combining REPEAT designations (da Capo)

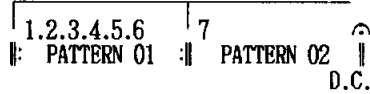
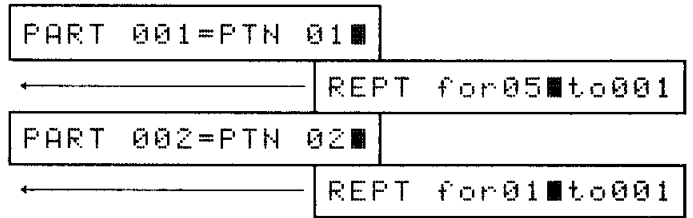
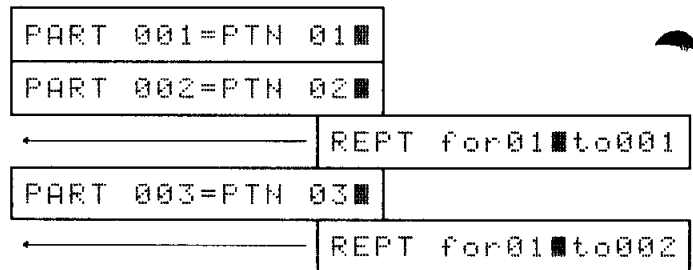

Fig 48 Example: combining REPEAT designations (dal Segno)



## Section 4-6 -- TEMPO CHANGE

This function will change the tempo after a specific PART. This function can be divided into three main steps: Step 1 which designates the TEMPO CHANGE beginning PART, Step 2 which sets the TEMPO CHANGE data, and Step 3 which writes the TEMPO CHANGE data onto the PART display.

The TEMPO function can be activated by pressing the TEMPO CHANGE key during the PART display.

The TEMPO CHANGE function cannot be activated during the SELECT SONG display, even when the TEMPO CHANGE key is pressed.

Since the TEMPO CHANGE function corresponds to the progression commands for the playback of a SONG, it will be memorized with a different format than that of note data.

The upper limit of the TEMPO data is J=250. Even if an attempt is made to increase the tempo by using the TEMPO CHANGE function, the tempo will not increase to above J=250.

Step 1. Designating the PART at which TEMPO CHANGE begins

Select the PART from where TEMPO CHANGE is to occur by using the +1/YES and -1/NO keys during the PART display.

Pressing the TEMPO CHANGE key will activate the TEMPO CHANGE function, determine the TEMPO CHANGE beginning PART and shift the TEMPO CHANGE function to Step 2.

The TEMPO will change from the PART following PART xxx which was selected during the PART display (PART xxx = PTN pp).

Step 2. Setting the TEMPO CHANGE data

Enter the TEMPO CHANGE data during the TEMPO CHANGE display.

Enter the TEMPO CHANGE data onto 00 of the TEMPO CHANGE display (CHANGE LEVEL 00%).

TEMPO CHANGE data can be entered by using the +1/YES and -1/NO keys. The TEMPO CHANGE data will shift at high speed when the +1/YES and -1/NO keys are held down.

The data represents the TEMPO CHANGE beat count. The data can be entered as desired over a range of 50 DOWN - 50 UP in 1 beat increments. For example, when the original tempo is J = 100, and the TEMPO CHANGE data is set to 50 UP, the resulting tempo will be J = 150. (See "Using the TEMPO CHANGE function".)

After the data has been entered, the display will change to either (TEMPO IS uu UP) or (TEMPO IS uu DOWN). uu is the TEMPO CHANGE data.

A 00 setting will result in no TEMPO CHANGE, and will be considered as a function cancel command.

TEMPO CHANGES can be carried out a number of times within a single song. The original tempo can be returned to simply by entering the same number for both UP and DOWN. (See "Using the TEMPO CHANGE function")

Multiple TEMPO CHANGE commands can be continuously written into a single PART. However, when designating a TEMPO CHANGE command, be sure to call out the PART (PART xxx in Step 1) previous to the PART where the TEMPO CHANGE is to occur. (See "Using the TEMPO CHANGE function")

When there is a TEMPO CHANGE command, the data of the TEMPO function will automatically be rewritten during PLAYBACK. However, when the next SONG is played back, it will be at the tempo designated by the TEMPO CHANGE command. when it is desired to return to the original tempo, enter a TEMPO RETURN command at the end of the SONG.

Pressing the TEMPO CHANGE once again will complete the function and return the RX-15 to the PART display.

Step 3. Writing TEMPO CHANGE data onto the PART display

When a TEMPO CHANGE command is carried out, the TEMPO CHANGE display will be written as is into the PART display as the TEMPO CHANGE data, the TEMPO CHANGE function will be cancelled, and the RX-15 will return to the PART display.

The TEMPO CHANGE data display (TEMPO IS uu UP) or (TEMPO IS uu DOWN) falls between the PART selected in Step 1, and the PART where the TEMPO CHANGE is to occur. (uu is the TEMPO CHANGE data)

When the TEMPO CHANGE data has been deleted by use of the DELETE function, the TEMPO CHANGE designation of that section will be cancelled. DATA that has already been written in can not be changed.

Operation procedure (Fig. 49)

- a) Activate the SELECT SONG display.
- b) Designate the SONG number by using the NUMBER keys.
- c) Activate the PART display by pressing the EDIT key.
- d) Determine the position where the TEMPO CHANGE will begin by using the +1/YES and -1/NO keys. The TEMPO will change from the PART following the selected PART.
- e) Activate the TEMPO CHANGE display by pressing the TEMPO CHANGE key.
- f) Enter the TEMPO CHANGE data by using the +1/YES and -1/NO keys.
- g) Pressing the TEMPO CHANGE key once again will complete the function and return the RX-15 to the PART display.

Fig 49 TEMPO CHANGE Operating Procedures

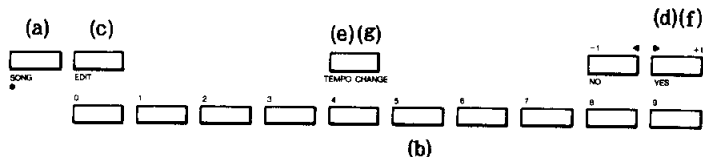

Using the TEMPO CHANGE Function

By combining TEMPO CHANGE commands, subtle tempo changes and extremely complex tempo changes can be carried out comparatively easily.

A TEMPO: return to original tempo

This function returns to the original tempo after a TEMPO CHANGE command has been carried out. Therefore, it is comparatively easy to program a SONG with an A-B-A configuration.

For example, when PART 001 IS J=100, PART 002 is J=150, PART 003 is J=100, the program on the display would be

(PART 001=PTN aa) (TEMPO IS 50 UP)  
(PART 002=PTN bb) (TEMPO IS 50 DOWN)  
(PART 003=PTN aa)

Ritardando: gradually slower. Accelerando: gradually faster.

The tempo can gradually be increased or decreased.

For example, when repeating a single PATTERN for 10 times in a row, by using this function, the beginning tempo can be J=100, gradually slowing down to J=80 on the final REPEAT.

This can easily be achieved by combining TEMPO CHANGE commands together with REPEAT commands in the following manner.

(PART 001=PTN aa) (TEMPO IS 02 DOWN) (rept FOR 09 TO 001).

However, be sure to place the TEMPO CHANGE commands before the REPEAT commands.

If this is not observed, the PATTERN will be repeated 10 times at the same tempo.

In the above example, by lessening the number of beats within the PATTERN, and increasing the REPEAT number and the number of TEMPO CHANGE commands, a smoother tempo transition can be achieved.

Sudden tempo changes

The tempo can be changed over a range of + 50 beats per time. However, by connecting two or more TEMPO CHANGE commands together, it is possible to achieve sudden tempo changes in excess of this limit.

For example, to create a SONG where the tempo begins at J=100, and suddenly increases to J=200 from PART 002, the commands would be as follows.

(PART 001=PTN aa) (TEMPO IS 50 UP) (TEMPO IS 50 UP)

### Section 4-7 -- CLEAR

This is the SONG cancel function. It has two main sub-functions: Step 1, which is INDIVIDUAL SONG CLEAR, and Step 2, which is ALL SONG CLEAR. Note that the procedure for each is different.

#### Step 1. SONG erase (CLEAR SONG)

This function will clear individual SONGs.

This function can be activated by pressing the CLEAR key during the SONG PLAYBACK STOP mode, or when the TEMPO function are activated.

However, the CLEAR function cannot be activated for a SONG that is empty.

Preselect the SONG to be cleared by using the SELECT SONG display. The SONG cannot be changed once the CLEAR function has been activated.

The CLEAR SONG display (CLEAR SONG ss0?) is a prompt that indicates "Should SONG 00 be erased?".

Answer the prompt by using the +1/YES and -1/NO keys.

Entering YES will clear the SONG, and the RX-15 automatically return to the SELECT SONG display after about 2 seconds, during which time (SONG ss CLEARED) will displayed.

Entering NO will cancel the CLEAR function and return the RX-15 to the SELECT SONG display.

#### Operation procedure (Fig. 50)

- a) Activate the SELECT SONG display.
- b) Designate the SONG number to be cleared by using the NUMBER keys.
- c) Activate the CLEAR SONG display by pressing the CLEAR key.
- d) Pressing the +1/YES key will clear the SONG and automatically return the RX-15 to the SELECT SONG display.

Fig 50 CLEAR SONG Operating Procedures

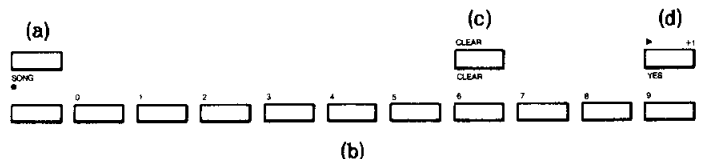

#### Step 2. CLEAR ALL SONG

This function will clear all SONGs simultaneously, and can also be used to initialize the memory.

This is a double-function of the ACCENT button and the STOP/CONTINUE button.

During the CLEAR SONG display, if the ACCENT and STOP/CONTINUE buttons are pressed simultaneously, the confirmation message "CLEAR ALL SONGS?" will appear. When the +1/YES key is pressed at this time, ALL CLEAR is executed. After about two seconds, the message "ALL SONGS CLEAR!" is displayed, and the RX-15 returns to the SELECT SONG display.

If the software of the RX-15 should become uncontrollable due to an operation error, using this function is very effective in correcting the problem.

In order to store the data, use the SAVE function of the FUNCTION mode to copy the data onto a cassette tape before carrying out the CLEAR ALL function.

Operation procedure (Fig. 51)

- a) Activate the SELECT SONG display.
- \* There is no need to enter the SONG number.
- b) Activate the CLEAR SONG display by pressing the CLEAR key.
- c) When the ACCENT and STOP/CONTINUE buttons are pressed simultaneously, a confirmation message appears.
- d) When the +1/YES key is pressed, ALL CLEAR is executed and the RX-15 will automatically return to the SELECT SONG display.

**Fig 51 SONG ALL CLEAR Operating Procedures**

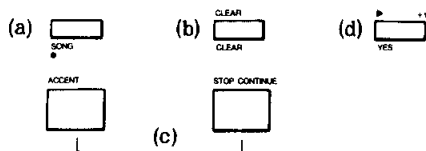

**Section 4-8 -- TEMPO**

This function determines the tempo. The TEMPO can be confirmed on the display. This is a mutual function identical to the TEMPO function of the PATTERN mode. Refer to the TEMPO function of the PATTERN mode.

**Section 4-9 -- PLAY SONG**

This function will play back SONGs. Initiate playback by pressing the START button.

Pressing the START button during the SELECT SONG display will activate the PLAYBACK mode and start playback. The RUN indicator will simultaneously light up and the PLAY SONG display (SONG ss PART xxx) will appear. xxx is the PART count; ss is the SONG number used for each PART.

The PART count will begin from 001, and advance according to the progression of the song.

The REPEAT data will not appear during playback, although the PART numbers will shift according to the REPEAT commands.

The TEMPO CHANGE data also will not appear during playback.

After the SONG has reached the final PART, the RX-15 will return to SELECT SONG display after about 2 seconds, during which time the PLAYBACK end display (SONG ss END) will appear. (ss is the SONG number.)

The playback of a SONG can be stopped by pressing the STOP/CONTINUE button during playback. Pressing the STOP/CONTINUE button once again will cause playback to re-start from the point where it was interrupted. If the START button is pressed instead, the SONG will be played back from the beginning.

When PLAYBACK has been interrupted, pressing the PATTERN/SONG key will cancel the PLAYBACK mode, and return the RX-15 to the SELECT SONG display.

Pressing the NUMBER keys when PLAYBACK has been interrupted, will cancel the PLAYBACK mode and cause the RX-15 to shift to the SELECT SONG display of the number entered.

When SONG playback is interrupted, different PARTs can be accessed via the +1/YES and -1/NO keys. PART numbers range from 001 to the last PART number of the particular SONG. When the +1/YES and -1/NO keys are pressed and held, PART access is done at high speed. When the STOP/CONTINUE button is pressed during this operation, playback will start from the beginning of the PART number currently displayed.

Operation procedure (Fig. 52)

- a) Activate the SELECT SONG display.
- b) Designate the SONG number to be played back by using the NUMBER keys.
- c) Pressing the START button, will activate the PLAYBACK mode and cause playback to begin.
- d) Press the STOP/CONTINUE button to interrupt playback.
- e) Press the PATTERN/SONG key to cancel the PLAYBACK mode.

**Fig 52 SONG Playback Procedure**

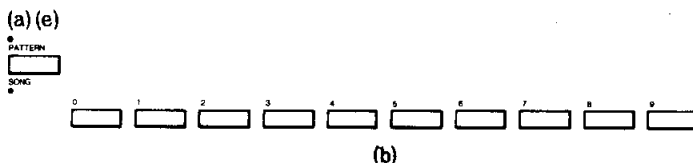

# Part 5: FUNCTION MODE/Other Functions

The FUNCTION mode primarily contains functions which control the exchange of data between the RX-15 and external devices. The various functions of the FUNCTION mode are enabled by pressing the key for the desired function while simultaneously pressing the FUNCTION key. The PATTERN and SONG indicators will light up when respective functions of the FUNCTION mode are employed.

## 5--1. SYNC

This function switches the RX-15's sound timing synchronization source from the internal clock to an external pulse wave or MIDI clock. This enables the RX-15 to be synchronized to external sequencers, rhythm machines, computers, etc.

During the SELECT PATTERN or SELECT SONG display, and the PATTERN or SONG PLAYBACK STOP modes, the SYNC function is activated by pressing the SYNC key while simultaneously pressing the FUNCTION key. The function can also be activated while using SWING, QUANTIZE, CLICK, and TEMPO options of the PATTERN mode, in the same manner.

The display (xxxCLOCK) appears on the LCD when the SYNC key is pressed indicating a synchronization source will appear. The "xxx" represents the respective synchronization source. INTERNAL will appear for the RX-15's internal clock, MIDI will appear for the MIDI clock and EXTERNAL will appear for an external pulse wave clock.

To select the synchronization source, use the NO of the -1/NO key. The display will give you synchronization source options in the following order: INTERNAL to EXTERNAL to MIDI to INTERNAL etc.

### INTERNAL

Employ this mode when you are using the RX-15 independently or to remotely control other external instruments or devices. In INTERNAL mode, the RX-15's internal clock is the synchronization source.

By pressing the SYNC key or the +1/YES, the INTERNAL CLOCK function is canceled and the RX-15 will return the SELECT PATTERN or the SELECT SONG prompt to the display.

### MIDI

The MIDI CLOCK function will synchronize the RX-15 to external MIDI standard sequencers, rhythm machines, etc. The MIDI signal is received from the MIDI IN port on the rear panel.

By pressing the SYNC or the +1/YES key, the MIDI CLOCK function is canceled and the RX-15 will return the SELECT PATTERN or the SELECT SONG prompt to the display.

### EXTERNAL

The EXTERNAL function will synchronize the RX-15 to external sequencers and rhythm devices that use pulse wave type clocks (gate signals). The pulse wave signal is received through the CASSETTE IN port on the rear panel. The EXTERNAL function can not be engaged while using the LOAD or VERIFY functions.

By pressing the SYNC or the +1/YES keys, the TIME BASE display will appear on the LCD (TIME BASE=tt/JJ). Here, "tt" represents TIME BASE data.

The TIME BASE data is the clock number that operates for each quarter note and must be set according to the standards of the external device that the RX-15 is to be synchronized with. The TIME BASE data is set between 24/J, 48/J, and 96/J by using the +1/YES and the -1/NO keys.

Pressing the SYNC key will cancel the EXTERNAL function and return the RX-15 to the SELECT PATTERN or SELECT SONG display.

When controlling external devices with the RX-15, remember that the internal pulse wave clock of the RX-15 is transmitted through the CASSETTE OUT port on the rear panel.

### OPERATING PROCEDURES (Figure 53)

- Activate either the SELECT PATTERN or SELECT SONG display.
- Activate the SYNC display by simultaneously pressing the SYNC and FUNCTION keys.
- Select the desired synchronization source by using the -1/NO key. If you choose EXTERNAL mode, activate the TIME BASE display by pressing the SYNC key in EXTERNAL mode. This will allow you to set the TIME BASE data.
- Press the SYNC key again to return the RX-15 to the SELECT PATTERN or SELECT SONG display.

Fig 53 SYNC Function Operating Procedures



The CASSETTE function enables Pattern and Song memory data to be transmitted and received between the RX-15 and external cassette tape units. While the CASSETTE IN and OUT ports have certain uses in other SYNC modes, only in INTERNAL mode of the SYNC function is the RX-15 able to save data received.

During the SELECT PATTERN and SELECT SONG displays, and the PATTERN and SONG PLAYBACK STOP modes, the CASSETTE CONTROL display can be enabled by simultaneously pressing the CASSETTE and FUNCTION keys. Also, when using SWING, QUANTIZE, CLICK, and TEMPO functions of the PATTERN mode, the CASSETTE CONTROL display can be enabled in the same manner.

When the CASSETTE CONTROL display appears on the LCD, you will be able to choose between the SAVE/VERIFY and LOAD functions. To cancel the CASSETTE function, simply press either the CASSETTE or -1/NO keys and the RX-15 will return to the SELECT PATTERN or SELECT SONG prompt.

Data transmission and reception between the RX-15 and external cassette tapes utilizes the CASSETTE IN/OUT ports on the rear panel. Connect the recording input terminal of the external cassette deck to the CASSETTE OUT port and the playback terminal of the external deck to the CASSETTE IN port. While the CASSETTE CONTROL display is shown, no data can be transmitted or received through the CASSETTE IN or OUT ports: either SAVE/VERIFY or LOAD keys have to be used for data transmission or reception.

Fig 54 CASSETTE IN OUT and Tapedeck Connexions

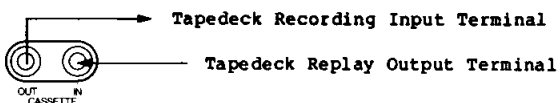

Operating Procedures (Figure 55)

- a) Activate either the SELECT PATTERN or SELECT SONG display.
- b) Activate the CASSETTE CONTROL display by simultaneously pressing the CASSETTE key and the FUNCTION key.
- c) Select the desired function: SAVE/VERIFY or LOAD.

Fig 55 CASSETTE Function Operating Procedure

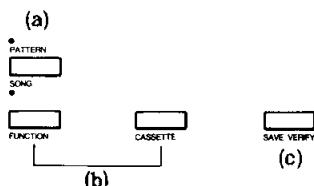

This function is used to copy data from the RX-15's memory to external cassette tape units. It has two main sub-functions: One, the copy or "SAVE" function, and two, to confirm that the data have been properly transferred; or to "VERIFY".

To activate the SAVE function, press the SAVE/VERIFY key when the CASSETTE CONTROL display is shown and the prompt "SAVE TO TAPE?" will appear. Pressing the SAVE/VERIFY key while the SAVE display is shown will activate the VERIFY function and the prompt "VERIFY TAPE?" will appear. BY pressing the SAVE/VERIFY key you can switch between the two function.

Pressing the -1/NO key when the SAVE display is shown will cancel the SAVE function and shift the RX-15 to the VERIFY mode. In the VERIFY mode, pressing the -1/NO key will return the RX-15 to the CASSETTE CONTROL display. In addition, pressing the CASSETTE key while either the SAVE or VERIFY display is shown will return the RX-15 to the CASSETTE CONTROL display.

You can return to either the SELECT PATTERN or SELECT SONG display by pressing the CASSETTE or -1/NO key while the CASSETTE CONTROL display is shown.

SAVING DATA (SAVE)

This sub-function of the SAVE/VERIFY function will copy data from the RX-15's internal memory to external cassette tapes. The function is activated by pressing the SAVE/VERIFY key while the CASSETTE CONTROL display is shown.

To save data, connect the recording input terminal of the external cassette deck to the CASSETTE OUT port on the rear panel of the RX-15 and set the deck to standby (PAUSE). Press the +1/YES key display the prompt "SAVE TO TAPE?". To answer yes, press the +1/YES key and the prompt "SAVE READY?" will appear. Before answering this prompt, be sure that all connections are properly made and the PAUSE mode of the external cassette deck is disengaged. Pressing the +1/YES key will start the copying process.

The display "SAVE EXECUTING" will appear for about 20 seconds, when this display goes off, the saving process is completed.

Once the saving process has been completed, the RX-15 will show the SAVE COMPLETED display briefly, then switch to the VERIFY mode. Stop the tape deck and rewind the tape to prepare for VERIFY function.

Pressing the -1/NO key in response to the SAVE READY? prompt will return the RX-15 to the SAVE TO TAPE? display.

To interrupt the saving process, press the CASSETTE key while the SAVE EXECUTING display is shown and the SAVE BREAK display will appear. After waiting about two seconds, press either the CASSETTE, +1/YES, -1/NO, SAVE/VERIFY, or LOAD keys, to return the RX-15 to the

CASSETTE CONTROL display. VERIFYING DATA (VERIFY)

This function will check and confirm that the data selected to be saved is on the cassette tape and, if there was an error in copying, direct you to re-SAVE the data. The VERIFY function is activated by pressing either the SAVE/VERIFY or -1/NO key while the SAVE display is shown.

To verify data that has been saved, connect the playback output terminal of the external cassette tape deck to the CASSETTE IN port on the rear panel of the RX-15, and set the tape deck to standby (PAUSE). Press the +1/YES key to display the prompt "VERIFY TAPE?". To answer yes, press the +1/YES key again and the prompt "VERIFY READY?" will appear. Before answering this prompt, be sure that all connection to the RX-15 and the external cassette deck are secure and that the PAUSE mode of the deck is disengaged. Press the +1/YES key and the verification process will begin.

The display "VERIFY EXECUTING" will appear and, if there are no errors on the tape, the verify process should take about 20 seconds. After the verification process is completed, the RX-15 will show the "VERIFY OK" display and return directly to either the SELECT PATTERN or SELECT SONG display, by passing the the CASSETTE CONTROL display. Stop the playback of the cassette deck.

If an error is detected, "VERIFY ERROR" will appear on the LCD. Return to the CASSETTE CONTROL display by pressing the -1/NO, SAVE/VERIFY, LOAD or CASSETTE keys, and re-SAVE the data.

The verification process can be interrupted by pressing the CASSETTE key while the "VERIFY EXECUTING" display is shown. The "VERIFY BREAK" display will be shown, allowing you to return to the CASSETTE CONTROL display by pressing the CASSETTE, +1/YES, -1/NO, SAVE/VERIFY, or LOAD keys.

By pressing the -1/NO key to the VERIFY READY prompt will return the RX-15 to the VERIFY display.

#### Operating Procedures (Figure 56)

- a) Connect an external cassette deck to the CASSETTE IN and OUT terminals on the rear panel of the RX-15.
- b) Activate either the SELECT PATTERN or the SELECT SONG display.
- c) Activate the CASSETTE CONTROL display by pressing the CASSETTE key while holding down the FUNCTION key.
- d) Activate the SAVE display by pressing the SAVE/VERIFY key.
- e) Set the external cassette deck to stand-by mode by pressing the PAUSE button.
- f) Activate the SAVE READY display by pressing the +1/YES key.
- g) Disengage the stand-by mode of the external deck.
- h) The saving process will take about 20 seconds during which time the display SAVE EXECUTING will be shown. Then the RX-15 will shift to the VERIFY display after briefly

showing the SAVE COMPLETION display.

- i) Stop the recording of the external deck and rewind the tape to prepare for the verification process.
- j) Activate the VERIFY display by pressing the +1/YES key.
- k) Press the +1/YES key again to begin the verification process.
- l) Start playback of the external deck.
- m) The verification process will take about 20 seconds during which the VERIFY EXECUTING display will appear. Then, the RX-15 will directly return to the SELECT PATTERN or SELECT SONG prompt after briefly showing the VERIFY COMPLETION display.

If there are any errors in the transmission of data, an error message will appear and the data must be re-saved. Do this by repeating steps c--m.

Fig 56 SAVE/VERIFY Operating Procedure

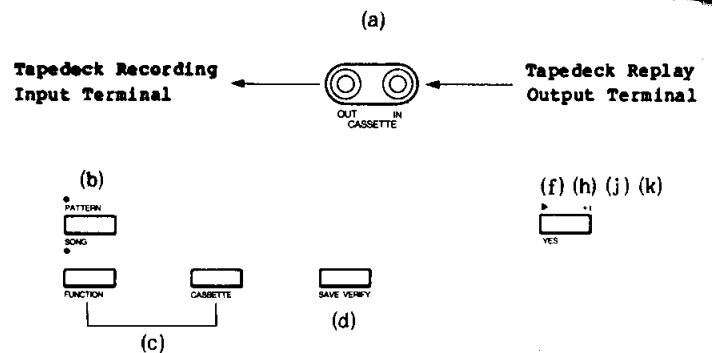

#### 5--4 LOAD

This function transmits data (PATTERN or SONG) stored on external cassette tapes to the RX-15. Data transferred from a cassette tape to the RX-15 will replace (totally erase) the internal memory of the RX-15. If you want to save the data in the internal memory, use the SAVE function as described above.

To LOAD data, connect the playback output terminal of the external tape deck to the CASSETTE IN port on the RX-15's rear panel, and set the external deck to stand-by mode by pressing the PAUSE button. (Figure 57).

Fig 57 CASSETTE IN and Tapedeck Connexions





As with the SAVE and VERIFY functions, the LOAD function has a two-stage prompt display for confirmation purposes. Answer with the +1/YES key to proceed with the LOAD operation. By pressing the LOAD key while the CASSETTE CONTROL display is shown, will activate the "LOAD FROM TAPE?" prompt.

Pressing the -1/NO key here will send the RX-15 back to CASSETTE CONTROL display canceling the LOAD FROM TAPE? prompt. Answering YES (by pressing the +1/YES key activate the "LOAD READY?" prompt. Press the +1/YES key again if you wish to continue and the "LOAD EXECUTING?" prompt will appear. Disengage the stand-by mode of the external cassette deck and start playback.

The LOAD process can be interrupted by pressing the CASSETTE key while the LOAD EXECUTING display is shown. The screen will then display "LOAD BREAK" indicating that the process has been interrupted. By pressing the +1/YES, -1/NO, LOAD, or the SAVE/VERIFY keys will send the RX-15 back to the CASSETTE CONTROL display. Interrupting the loading process will leave untransferred data on the cassette tape and incomplete data in the RX-15's internal memory. You may either re-LOAD the data, or erase the RX-15's memory by use of the ALL CLEAR key.

As in the verification process, when the LOAD process, with no errors detected, is completed the RX-15 will return directly to the SELECT PATTERN or SELECT SONG display, bypassing the CASSETTE CONTROL display. The display "LOAD OK" will appear briefly.

If there are any errors in loading, a "LOAD ERROR!" display will appear. Return the RX-15 to the CASSETTE CONTROL display by pressing the -1/NO, SAVE/VERIFY, LOAD, or CASSETTE keys. Check all connections to the RX-15 and the external tape deck, and try the loading process again.

#### Operating Procedures (Figure 58)

- a) Connect the external cassette deck to the CASSETTE IN port on the rear panel of the RX-15.
- b) Activate either the SELECT PATTERN or SELECT SONG display.
- c) Activate the CASSETTE CONTROL display by simultaneously pressing the CASSETTE and FUNCTION keys.
- d) Activate the LOAD display by pressing the LOAD key.
- e) Set the cassette deck to standby playback mode by pressing PAUSE.
- f) Press +1/YES and activate the LOAD READY? prompt.
- g) Press the +1/YES key again to beginning the loading process.
- h) Start the playback of the external tape deck by disengaging the standby mode.
- i) The LOAD EXECUTING display will appear on the screen. The loading process takes about 20 seconds and when loading is finished the RX-15 will return to the SELECT PATTERN or SELECT SONG display after briefly showing the "LOAD COMPLETION" display.

If there are any errors detected during the loading process, an error message will appear and the process must be started from step c again.

Fig 58 LOAD Function Operating Procedure

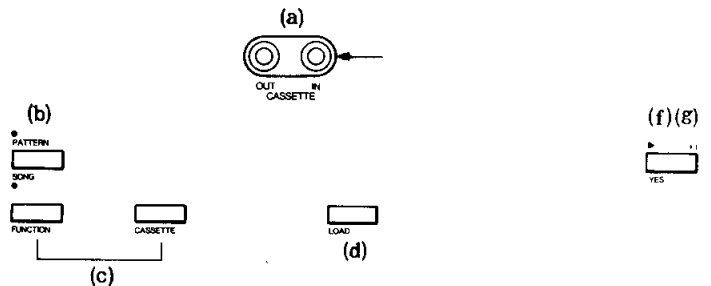

#### 5--5 INST

When two instruments (SD, HH CLOSED, SHAKER/COWBELL) share a single INSTRUMENT key, this function is used to select the desired instrument. The INST function is activated during the SELECT PATTERN or SELECT SONG display by simultaneously pressing the INST and FUNCTION keys. It can also be activated in the same manner when using SWING, QUANTIZE, CLICK or TEMPO functions of the FUNCTION mode.

Activating the INST function will cause the INST SELECT MODE display to appear and the PATTERN or SONG indicators will light up to indicate which mode you are in. Pressing the INSTRUMENT button during this display will cause the prompt (SELECT xxx) to be displayed. Here, xxx represents the name of the instrument to be selected. Pressing the -1/NO will give you alternate selection of the instrument on that key. The RX-15 is returned to the SELECT PATTERN or SELECT SONG display by pressing the INST key to the SELECT xxx prompt.

In brief, the instruments that can be selected on the RX-15 are SD, HH, and SHAKER/COWBELL. SD controls a deep-sounding, deep-bodied snare drum (MEDIUM) and a high-tuned snare drum (HI TUNE). The HH CLOSED controls a stick-work closed hi-hat (CLOSED), and a pedal-work hi-hat (PEDAL). The SHAKER/COWBELL key gives you selection between these two instruments. These two sounds can be programmed into the same Pattern on the same note and played back independently during the PLAYBACK mode.

#### Operating Procedures (Figure 59)

- a) Activate the SELECT PATTERN or SELECT SONG display.
- b) Activate the INST function by simultaneously pressing the INST and FUNCTION keys.
- c) Activate the INSTRUMENT NAME display (SELECT xxx) by pressing the INSTRUMENT key.
- d) Select the desired instrument by using the -1/NO key.
- e) Pressing the INST key while the SELECT xxx prompt is displayed will return the RX-15 to the SELECT PATTERN or SELECT SONG display.

Fig 59 INST Function Operating Procedure

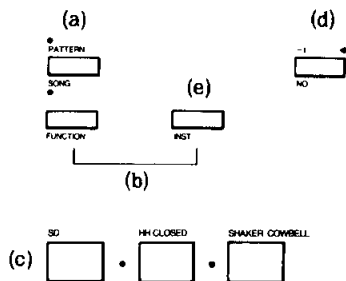

5--6 MIDI IN/OUT

The MIDI IN/OUT functions designates the transmission and reception of MIDI signals through the MIDI IN and MIDI OUT ports on the rear panel of the RX-15. Basically, a KEY NUMBER is transmitted and received by the MIDI function. A KEY NUMBER indicates the relative height of each sounds for the notes of the RX-15 instrument that do not possess pitch. This is identical to the KEY NUMBER that represents which key was played on a MIDI standard keyboard.

MIDI IN determines the reception process of MIDI signals received by the RX-15 through the MIDI in port. MIDI OUT determines the transmission process of MIDI signals sent by the RX-15 through the MIDI OUT port. The MIDI OUT of the external instrument or device must be connected to the MIDI IN port of the RX-15 and conversely, the MIDI IN of the external device is connected to the MIDI OUT port of the RX-15. (Figure 60)

Fig 60 MIDI Terminal Connexion

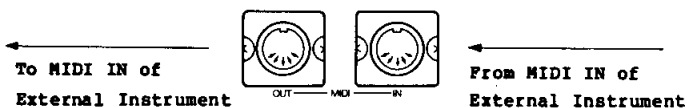

MIDI IN (MIDI Signal Reception)

The MIDI IN function, used for reception of MIDI signals, is broken down into four steps: Step 1, KEY NUMBER reception and ON/OFF control. Step 2, Designating the OMNI mode. Step 3, Designating the reception channel. And Step 4, designating the KEY NUMBER for each individual instrument.

Step 1 can be activated by simultaneously pressing the MIDI IN and FUNCTION key while the SELECT PATTERN, SELECT SONG, PATTERN PLAYBACK STOP or SONG PLAYBACK SONG displays are shown. It can also be activated in this manner while using SWING, QUANTIZE, CLICK, and TEMPO of the FUNCTION mode.

proceeding from one Step to the next occurs after completing all the requirements of the Step. However Step 4 is reached only by pressing the INSTRUMENT key during Steps 2 or 3.

STEP 1. KEY NUMBER Reception ON/OFF Control.

This is a master switch function which switches the KEY NUMBER reception ON and OFF. It is activated by simultaneously pressing the MIDI in and FUNCTION keys. Once activated, the reception display (RECEIVE ---) will appear. Depending on which one is selected, either AVAIL or UNAVAIL will appear in place of "---".

To select between AVAIL and UNAVAIL, use the -1/NO key which will display these choices alternatively. When AVAIL is displayed, pressing the +1/YES key will shift the MIDI IN function to Step 2 (designating the OMNI mode). When UNAVAIL is displayed, pressing the +1/YES key will cancel the MIDI IN function and send the RX-15 back to the SELECT PATTERN or SELECT SONG display.

STEP 2. Designating the OMNI mode

The OMNI mode enables KEY NUMBER data reception on all MIDI channels (1--16 ch). The function is activated by pressing either the MIDI IN or +1/YES key while the RECEIVE AVAIL display is shown. Activating the function will cause the RX-15 to display "OMNI ---0". Depending on what is desired, either, ON or OFF will appear in place of "---".

To select between ON and OFF, use the -1/NO key which will display choices alternatively. Pressing the +1/YES key will return the RX-15 to the SELECT PATTERN or SELECT SONG display. During OMNI mode ON, MIDI signals can be received regardless of the MIDI transmission channel.

During OMNI mode OFF, the RX-15's reception channel must be designated by according to the MIDI channel of the transmission side. This is done in Step 3 (designating the reception channel). Pressing the MIDI IN or the +1/YES key during OMNI mode OFF will shift the MIDI IN function to Step 3.

Regardless of whether you are using OMNI mode ON or OFF, pressing the INSTRUMENT key will shift the MIDI IN function to Step 4.

STEP 3. Designating the MIDI Reception Channel.

This function selects the MIDI reception channels (1--16ch) of the RX-15 according to the external MIDI signal transmission. The function is activated by pressing the MIDI IN key or the +1/YES key during the OMNI mode OFF display. Activating this function will cause the display "RECEIVE CH=mm" to appear. Here, "mm" represents the MIDI channel number.

The MIDI reception channel number is set by using the DATA ENTRY control which can be set between 1--16. Pressing the MIDI IN key again will send the RX-15 back to the SELECT PATTERN or SELECT SONG display. And pressing the INSTRUMENT key during Step 3 will shift the MIDI IN function to Step 4 (designating the key number).

#### STEP 4. Designating the KEY NUMBER for Each Individual Instrument

This function designates the KEY NUMBER for each instrument so that the RX-15, INSTRUMENT keys, external synthesizers and other keyboards can be linked together for remotely controlled performances.

Since both the reception and transmission KEY NUMBERS can be simultaneously designated a wide range of instrument combinations are possible: Melody sequences from external sequencers and synthesizers can be received and performed together with percussion instrument sounds of the RX-15. Likewise, Rhythm patterns from the RX-15 can be transmitted and converted into melodies which can be performed by external sequencers and synthesizers. During signal transmission the transmission KEY NUMBER must be designated by the MIDI OUT function.

During Steps 2 or 3, pressing the INSTRUMENT key will shift the RX-15 to Step 4 and the display "xxx NOTE=nn" will appear. Here, "xxx" represents the instrument and "nn" represents the KEY NUMBER. The function cannot be activated during OMNI mode OFF. Pressing the INSTRUMENT key here will send the RX-15 back to the SELECT PATTERN or SELECT SONG display.

Set the KEY NUMBER by using the DATA ENTRY control. The DATA ENTRY control has a range of 36 (C1) to 99 (D#6). Pressing the MIDI IN key when the xxx NOTE=nn display is shown will return the RX-15 to the SELECT PATTERN or SELECT SONG display.

#### MIDI OUT (MIDI Signal Transmission)

Continuing with the Steps from the MIDI IN function, the MIDI OUT functions has two sub-functions: Step 5, KEY NUMBER transmission ON/OFF control, and Step 6, Designating the MIDI transmission channel for each instrument. Step 5 is activated by simultaneously pressing the MIDI OUT and FUNCTION keys while the SELECT PATTERN, SELECT SONG, PATTERN SONG PLAYBACK, or SONG PLAYBACK STOP displays are shown. It can also be activated in the same manner while using the SWING, QUANTIZE, CLICK and TEMPO functions of the PATTERN mode.

Pressing the MIDI OUT key during Step 5 will cancel the function and pressing the INSTRUMENT key during Step 5 will shift the MIDI OUT function to Step 6.

#### Step 5. KEY NUMBER Transmission ON/OFF

This function switches ON and OFF the KEY NUMBER transmission that matches the instrument sound of the RX-15 to the keyboard of external synthesizers. Again, this function is activated by simultaneously pressing the MIDI OUT and FUNCTION keys. Once activated, the display "TRANSMIT---" will appear. As with MIDI IN, AVAIL or UNAVAIL will appear in place of "---" depending on what

you've chosen. However, here AVAIL will mean "transmission possible" and UNAVAIL means "transmission impossible".

AVAIL and UNAVAIL will be displayed alternatively each time the -1/NO key is pressed.

When AVAIL (transmission possible) is displayed, external synthesizers can be controlled by the PATTERN PLAYBACK or SONG PLAYBACK functions, or by performing directly into the INSTRUMENT keys. Following the designation of the KEY NUMBER for the MIDI IN function, the respective instrument sounds will be divided and allocated to the keyboard, and the RX-15 will function as a sequencer.

Regardless of whether AVAIL or UNAVAIL is displayed, pressing the +1/YES or MIDI OUT keys will cancel the function and return the RX-15 to the SELECT PATTERN or SELECT SONG displays. Also, pressing the INSTRUMENT key, regardless of whether the transmission is ON or OFF will shift the the function to Step 6 (designating the MIDI Transmission Channel for Each Instrument).

#### STEP 6. Designating the MIDI Transmission Channel for Each Instrument.

This function designates the MIDI transmission channel for each INSTRUMENT key. This function is used to control one or more external instruments or devices by using a single RX-15 unit. The function is activated by pressing the INSTRUMENT key when the "TRANSMIT---" display is shown. The display "xxx TRNS CH=mm0" will appear for the INSTRUMENT key that was pressed. Here, "xxx" stands for the instrument and "mm" is the MIDI transmission channel to be used.

The transmission channel is set by use of the DATA ENTRY control which ranges from 1--16ch. By pressing the MIDI OUT key during the transmission channel display (xxx TRNS CH=mm0) will cancel the function and return the RX-15 to the SELECT PATTERN or SELECT SONG display.

#### Operating Procedures

There are many systems that can be designed around the MIDI ports. Here, four examples are covered step by step. Example 1: synchronized performance of the RX-15 controlled by external instruments or devices; Example 2: sequential control of the RX-15 by external instruments or devices; Example 3: synchronized performance of external instruments or devices controlled by the RX-15; and Example 4: sequential control of external instruments or devices by the RX-15.

**EXAMPLE 1:** Synchronized Performance of the RX-15 Controlled by External Instruments or Devices. (Figure 61)

This procedure will synchronize the automatic performance of the RX-15 to the clock of external sequencers, rhythm machines and computers.

- a) Connect the MIDI IN port of the RX-15 to the MIDI OUT port of the external device. When the external device uses a pulse wave clock (gate signal), connect the CASSETTE IN port of the RX-15 to the CLOCK OUTPUT port of the external device.
- b) Activate the SELECT PATTERN or SELECT SONG display.
- c) Activate the SYNC display by simultaneously pressing the SYNC and FUNCTION keys.
- d) Select the MIDI CLOCK by using the -1/NO key. When the external device uses a pulse wave clock, select EXTERNAL CLOCK and set the TIME BASE.
- e) Press the SYNC key to cancel the function.
- f) Start the performance with the external instrument or device.

**EXAMPLE 2:** Sequential Control of RX-15 by External Instruments or Devices.

This procedure enables the manual or auto performance data (KEY NUMBER data) of external rhythm machines or synthesizers to play the RX-15.

- a) Connect the MIDI IN port of the RX-15 to the MIDI OUT port of the external device.
- b) Activate the SELECT PATTERN or SELECT SONG display.
- c) Activate the KEY NUMBER reception display (RECEIVE ---) by simultaneously pressing the MIDI IN and FUNCTION keys.
- d) Set the MIDI RECEPTION to AVAIL by using the -1/NO key.
- e) Activate the OMNI mode display by using the -1/NO key.
- f) Turn ON the OMNI mode by using the -1/NO key.
- g) Activate the KEY NUMBER display (xxx NOTE=nn) by pressing the INSTRUMENT keys.
- h) Designate a KEY NUMBER for every instrument selected by using the DATA ENTRY control.
- i) Cancel the function by pressing the MIDI IN key.
- j) Start the performance with external instruments or devices.

**EXAMPLE 3:** Synchronized Performance of External Instruments or Devices Controlled by the RX-15. (Figure 63)

This procedure is used to synchronize the automatic performance of external sequencers or rhythm machines to the internal clock of the RX-15.

- a) Connect the MIDI OUT port of the RX-15 to the MIDI IN port of the external instrument or device. When the

external device is uses a pulse wave clock, connect the CASSETTE OUT port to the CLOCK INPUT port of the external device.

- b) Begin playback of the RX-15. The clock signals of the RX-15 will be transmitted from the MIDI OUT and CASSETTE OUT ports during playback.

When the KEY NUMBER transmission has been set to AVAIL, the KEY NUMBER will be transmitted from the RX-15 along the clock signal. When it is sufficient to simply synchronize the external instrument or device to the RX-15's internal clock, set the KEY NUMBER transmission to UNAVAIL.

**Fig 61 Procedure for Synchronized Performance of the Main Unit via External Instruments**

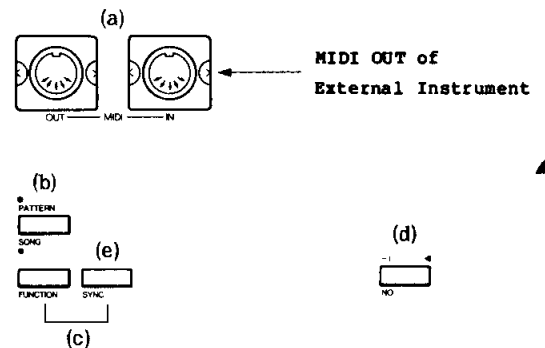

**Fig 62 Procedure for Sequence Control of Main Unit via External Instruments**

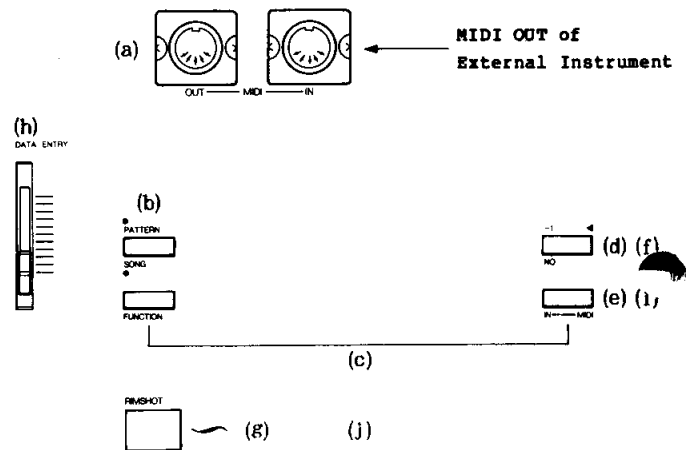

**Fig 63 Procedure for Synchronized Control of External Instruments via Main Unit**

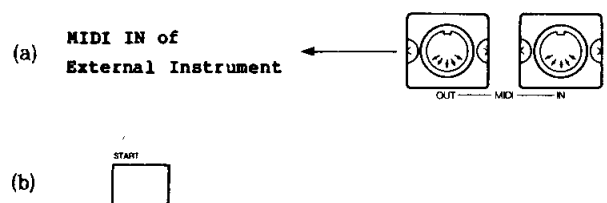

EXAMPLE 4: Sequential Control of External Devices by the RX-15.

This procedure enables the manual performance or PLAYBACK functions of the RX-15 to control external rhythm machines or synthesizers. This will in effect, turn the RX-15 into a sequencer. Based on the characteristics of percussion instrument sounds, the interval between the KEY OFF and the KEY ON signal of the RX-15 KEY NUMBER data is shorter than normal. Set the external reception instrument or device to sounds with a fast attack and a long release. Sometimes, sounds with slow attacks or short releases may not be voiced.

a) Connect the MIDI OUT port of the RX-15 to the MIDI IN port of the external device.

b) Activate the SELECT PATTERN or SELECT SONG display.

c) Activate the KEY NUMBER reception display by simultaneously pressing the MIDI IN and FUNCTION keys.

d) Set the KEY NUMBER reception to AVAIL by use of the 1/NO key.

e) Activate the OMNI mode display by use of the MIDI IN key.

f) Turn ON the OMNI mode by using the -1/NO key.

g) Activate the KEY NUMBER display by pressing the INSTRUMENT key.

h) Designate KEY NUMBERS for every instrument selected by using the DATA ENTRY control.

i) Cancel the function by pressing the MIDI IN key.

j) Activate the KEY NUMBER transmission display by simultaneously pressing the MIDI OUT and FUNCTION keys.

k) Set the KEY NUMBER transmission mode to AVAIL by using the -1/NO key.

l) Activate the transmission channel display by pressing the INSTRUMENT key.

m) Designate the transmission channel by using the DATA ENTRY control.

Set the transmission channel according to the reception side. When setting channels for multiple reception devices, change the transmission channel for each external device.

n) Cancel the function by pressing the MIDI OUT key.

o) Start PLAYBACK or manual performance of the RX-15

Fig 64 Procedure for Sequence Control of External Instruments via Main Unit

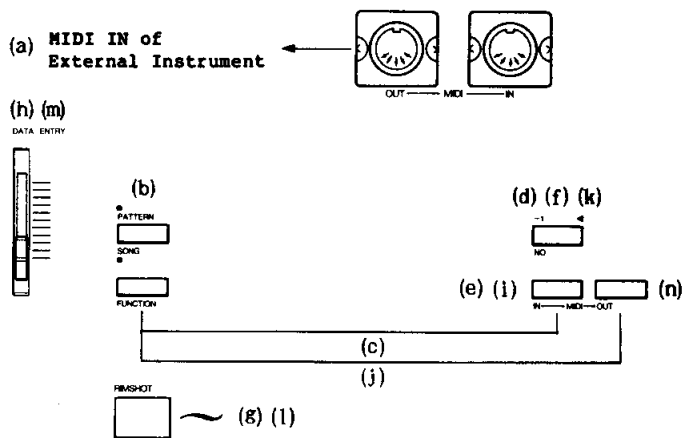

# Part 6: SPECIFICATIONS

## \*SOUND SOURCE

ROM: 256 KBIT WAVE ROM x 4  
NO. OF TONES: 15

## \*MEMORY CAPACITY

NO. OF PATTERNS: 100  
NO. OF SONGS: 10  
MAXIMUM NO. OF PARTS WITHIN SONGS: 255

## \*CONTROLLERS

### \*SLIDER

VOLUME, TEMPO, DATA ENTRY

### \*BUTTON

PAN, INST LEVEL, ACCENT LEVEL, ACCENT,  
INSTRUMENT RIM SHOT, SD (MEDIUM/HI TUNE), TOM 1, TOM 2, TOM 3, BD, HH OPEN, HH CLOSED, (CLOSED/PEDAL), RIDE, CRASH, SHAKER/COWBELL, CLAPS, START, STOP/CONTINUE.

### \*KEY

MODE SELECTOR (PATTERN/SONG, FUNCTION)  
PATTERN MODE PARAMETER (REAL TIME WRITE, STEP WRITE, COPY, SWING, QUANTIZE, CLICK, CLEAR, TEMPO)  
SONG MODE PARAMETER (EDIT, INSERT, DELETE, REPEAT, TEMPO CHANGE)

FUNCTION MODE PARAMETER (SYNC, CASSETTE, SAVE/VERIFY, LOAD, INST, MIDI IN, MIDI OUT)

NUMBER (0-9, 1/4-1/192)

+1/YES, -1/NO

### \*SWITCH

POWER SWITCH

## \*DISPLAY

\*LCD: 16 CHARACTERS

LED INDICATOR: PATTERN, SONG, RUN

## \*CONNEXION TERMINALS AND INTERFACES

\*AUDIO OUTPUT: OUTPUT L&R (phone jack), PHONES (stereo phone jack, 8-40 omegas)

\*CONTROL JACK: FOOT SW

\*INTERFACE: CASSETTE (IN, OUT), MIDI (IN, OUT)

## \*DIMENSIONS AND WEIGHT

\*400W X 68H X 270D (MM)

\*2.8 Kg

## \*POWER SOURCE

specify according to country

SPECIFICATIONS ARE LIABLE TO CHANGE WITHOU NOTICE.

## 6.2 Block Diagram

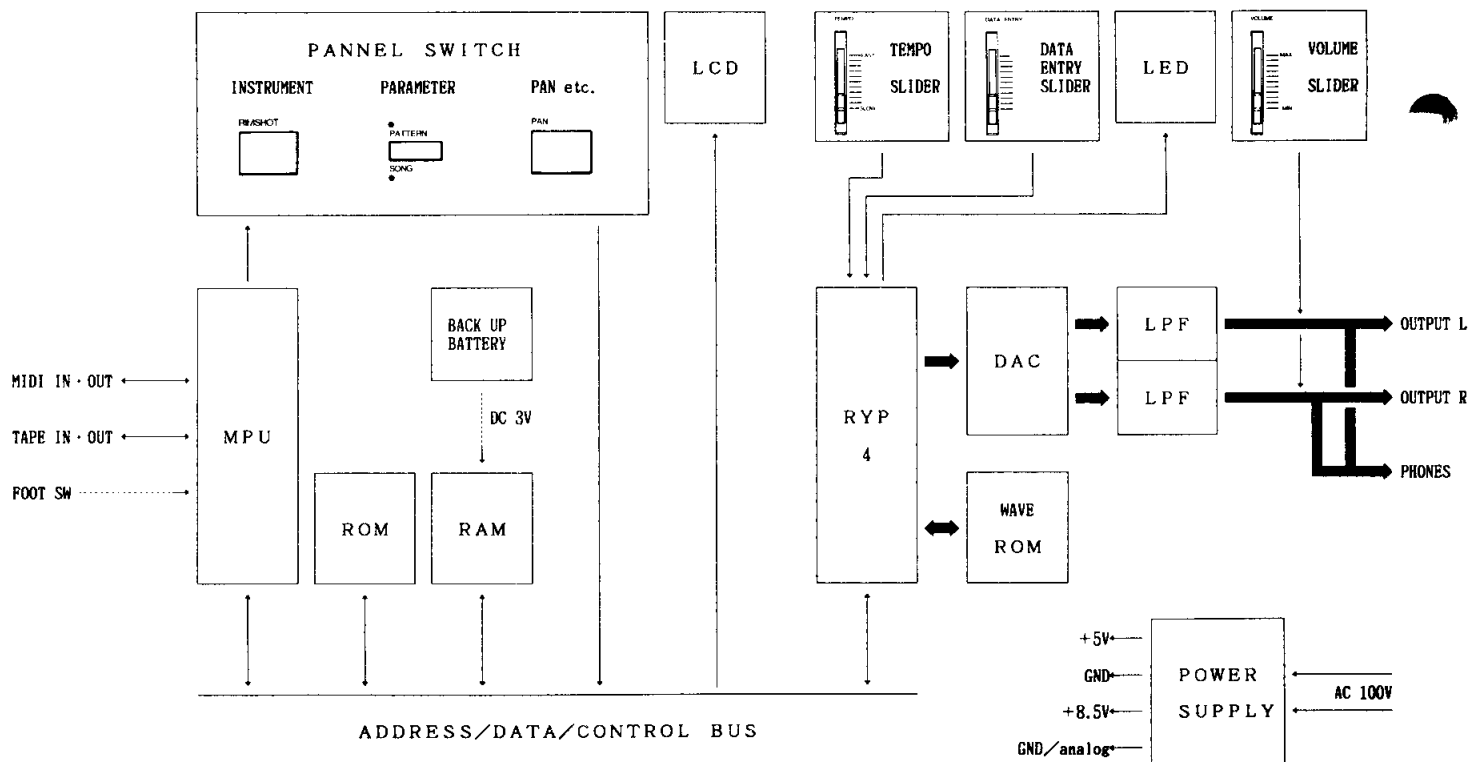



SINCE 1887



**YAMAHA**

NIPPON GAKKI CO., LTD. HAMAMATSU, JAPAN

OMD-88 8453  Printed in Japan