



RX-V367

AV Receiver

Owner's Manual

English for Europe

CONTENTS

INTRODUCTION

Features and capabilities	3
About this manual.....	4
Supplied accessories	4
Part names and functions	5
Front panel.....	5
Rear panel.....	6
Front panel display	7
Remote control	8

CONNECTIONS

Connecting speakers	9
Speaker channels and functions.....	9
Speaker layout	10
Connecting speakers.....	10
Connecting external devices	12
Cable plugs and jacks	12
Connecting a TV monitor.....	13
Connecting BD/DVD players and other devices	15
Connecting video cameras and portable audio players ..	19
Transmitting input A/V to external devices.....	19
Connecting the FM/AM antennas	20
Set up the speaker parameters automatically (YPAO)	21

PLAYBACK

Basic playback procedure	25
Adjusting high/low-frequency sound (Tone control)	25
Changing input settings with a single key (SCENE function)	26
Registering input sources/sound field program	26
Enjoying sound field programs	26
Selecting sound field programs and sound decoders.....	26
Sound field programs	28

FM/AM tuning	30
Selecting a frequency for reception (Normal tuning).....	30
Registering and recalling a frequency (Preset tuning) ...	31
Clearing preset stations	32
Radio Data System tuning.....	32

SETUP

Configuring the settings specific for each input source (Option menu)	34
Option menu display and setup	34
Option menu items	34
Setting various functions (Setup menu)	36
Setup menu display and settings	36
Setup menu items	36
Manages settings for speakers.....	37
Setting the audio output function of this unit.....	40
Making the receiver easier to use	42
Setting sound field program parameters.....	43
Prohibiting setting changes	43
Setting sound field program parameters	44
Setting sound field parameters	44
Extended functionality that can be configured as needed (Advanced Setup menu)	46
Displaying/Setting the Advanced Setup menu.....	46
Avoiding crossing remote control signals when using multiple Yamaha receivers	46
Initializing various settings for this unit.....	46

APPENDIX

Troubleshooting	47
General	47
HDMI™	49
Tuner (FM/AM)	50
Remote control	51
Glossary	52
Audio information	52
Sound field program information	52

Video information	53
Information on HDMI™	54
About trademarks	54
Specifications	55
Index	56

INTRODUCTION

Features and capabilities

■ Built-in high-quality, high-power 5-channel amplifier	
■ 1-button input/sound field program switching (SCENE function)	26
■ Speaker connections for 2- to 5.1-channel configurations	
– Speaker channels and functions	9
– Speaker layout.....	10
– Speaker cable connection.....	10
– Subwoofer cable connection	11
■ Acoustic parameter adjustment to match your speakers and listening environment	
– Automatic settings for speaker acoustic parameters (YPAO - Yamaha Parametric Room Acoustic Optimizer).....	21
– Specifying the settings for each speaker	37
– Volume control for each speaker.....	38
– Speaker distance settings	38
– Sound quality control with the equalizer <Graphic Equalizer>	39
– Test tone speaker adjustment	39
– Bass and treble level adjustment <Tone Control>	25
■ External device connection and playback	
– Cables and input/output jacks for this unit	12
– TV connection.....	13
– TV audio playback through this receiver	14
– Connections for BD/DVD players (recorders) and other devices.....	15
– Audio signal output to the TV connected via the HDMI jack	41
– Correction of lag between audio and video signals <Lipsync>	40
– External audio and video recorder connections	19
– HDMI/AV video input combining other audio input.....	35
– Front panel external device connections (for video cameras, portable music players, etc.).....	19
– Protective cover for front panel jacks	4
– Changing the input source names <Input Rename>	42
– Configuring the settings specific for each input source <Option menu>	34
– Playback from external devices	25
■ FM/AM Tuner	
– FM/AM broadcast listening	30
– Simple preset tuning	31
– Radio Data System tuning	32
– Automatic traffic information reception	33
■ Multi-channel, multi-format playback	
– Sound field effect selection.....	26
– Playback without sound field effects	27
– Stereo playback.....	27
– Sound field effect configuration	44
– Compressed-music playback	26
■ Front panel information display	
– Front panel display information switching	7
– Front panel display brightness adjustment <Dimmer>.....	43
– Digital video/audio signal information display <Signal Info>.....	35
■ Volume/sound quality adjustment functions	
– Easy listening at low volumes <Adaptive DRC>	40
– Maximum volume settings.....	41
– Startup volume settings.....	41
– Adjusting volume between input sources <Volume Trim>	34
■ Remote control operation	
– Remote control names and functions.....	8
– Insert batteries into the remote control	4
– Multiple Yamaha receiver operation without signal interference <Remote ID Switching>.....	46
■ Other features	
– Standby mode after prolonged non-operation <Auto Power Down function>.....	43
– Standby mode after a specific amount of time <Sleep timer>.....	8
– Initializing various settings for this unit	46
– Prohibiting setting changes <Memory Guard>.....	43



About this manual

- This manual is printed prior to production. Design and specifications are subject to change in part as a result of improvements, etc. In case of differences between the manual and product, the product has priority.
- “**3**HDMI1” (example) indicates the name of the parts on the remote control. Refer to the “Part names and functions” (p. 5) for the information about each position of the parts.
- **1** indicates that the reference is in the footnote. Refer to the corresponding numbers on the bottom of the page.
- **1** indicates the page describing the related information.
- Click on the “**1**” at the bottom of the page to display the corresponding page in “Part names and functions.”

- 1** Front panel
- 2** Rear panel
- 3** Front panel display
- 4** Remote control

Supplied accessories

Check that you received all of the following parts.

- Remote control
- Batteries (AAA, R03, UM-4) x 2
- YPAO microphone
- AM loop antenna
- Indoor FM antenna
- VIDEO AUX input cover

■ Attaching the VIDEO AUX input cover (included)

To protect against dust, attach the supplied VIDEO AUX input cover to the VIDEO AUX jacks when you do not use the jacks. To remove the cover, push the left section of it.

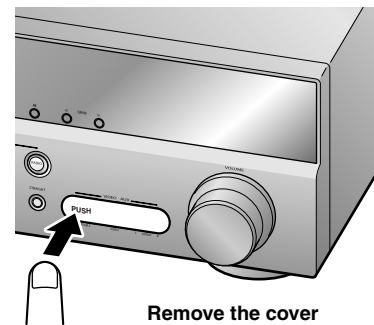
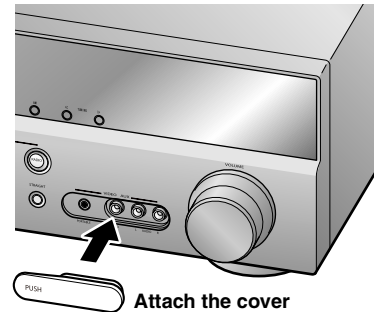

■ Installing batteries in the remote control

When inserting batteries in the remote control, remove the battery compartment cover from the reverse side of the remote control, and insert two AAA batteries into the battery compartment so that they match with the polarity markings (+ and -).

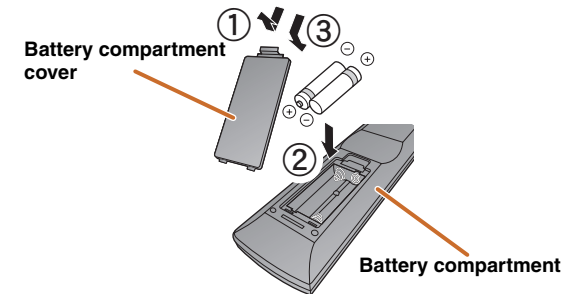

Replace the batteries with new ones if the following symptoms become evident:





- The remote control can only be operated within a narrow range.
- **2**TRANSMIT does not light up, or only lights dimly.

NOTE

If there are remote control codes for external components registered to the remote control, removing the batteries for more than two minutes, or leaving exhausted batteries in the remote control, the remote control codes may be cleared. If this should occur, replace the batteries with new ones, and set the remote control codes.

Part names and functions

Front panel

- ① **⏻ (Power)**
Switches this unit between on and standby modes.
- ② **YPAO MIC jack**
Connect the supplied YPAO microphone and adjust the speaker balance automatically (p. 21).
- ③ **INFO**
Changes the information shown on the front panel display (p. 7).
- ④ **MEMORY**
Registers FM/AM stations as preset stations (p. 31). 
- ⑤ **PRESET </>**
Selects an FM/AM preset station (p. 32). 
- ⑥ **FM**
Sets the FM/AM tuner band to FM (p. 30). 
- ⑦ **AM**
Sets the FM/AM tuner band to AM (p. 30). 
- ⑧ **TUNING <</>>**
Changes FM/AM tuner frequencies (p. 30). 
- ⑨ **Front panel display**
Displays information on this unit (p. 7).
- ⑩ **PHONES jack**
For plugging headphones in. Sound effects applied during playback can also be heard through the headphones.
- ⑪ **INPUT </>**
Selects an input source from which to playback. Press either the left or right key repeatedly to cycle through the input sources in order.
- ⑫ **SCENE**
Switches the input source and the sound field program with a single button (p. 26). Press this key when this unit is in standby mode to switch on the unit.
- ⑬ **TONE CONTROL**
Adjusts high-frequency/low-frequency output of speakers/headphones (p. 25).
- ⑭ **PROGRAM </>**
Switches between the sound field effect (sound field program) you are using and the surround sound decoder (p. 26). Press either the left or right key repeatedly to cycle through the input sources in order.
- ⑮ **STRAIGHT**
Changes a sound field program to straight decoding mode (p. 27).
- ⑯ **VIDEO AUX jacks**
For connecting video cameras, game consoles, and portable music players to this unit temporarily. Attach the supplied VIDEO AUX input cover when not using this jack.
- ⑰ **VOLUME**
Adjusts the volume level.

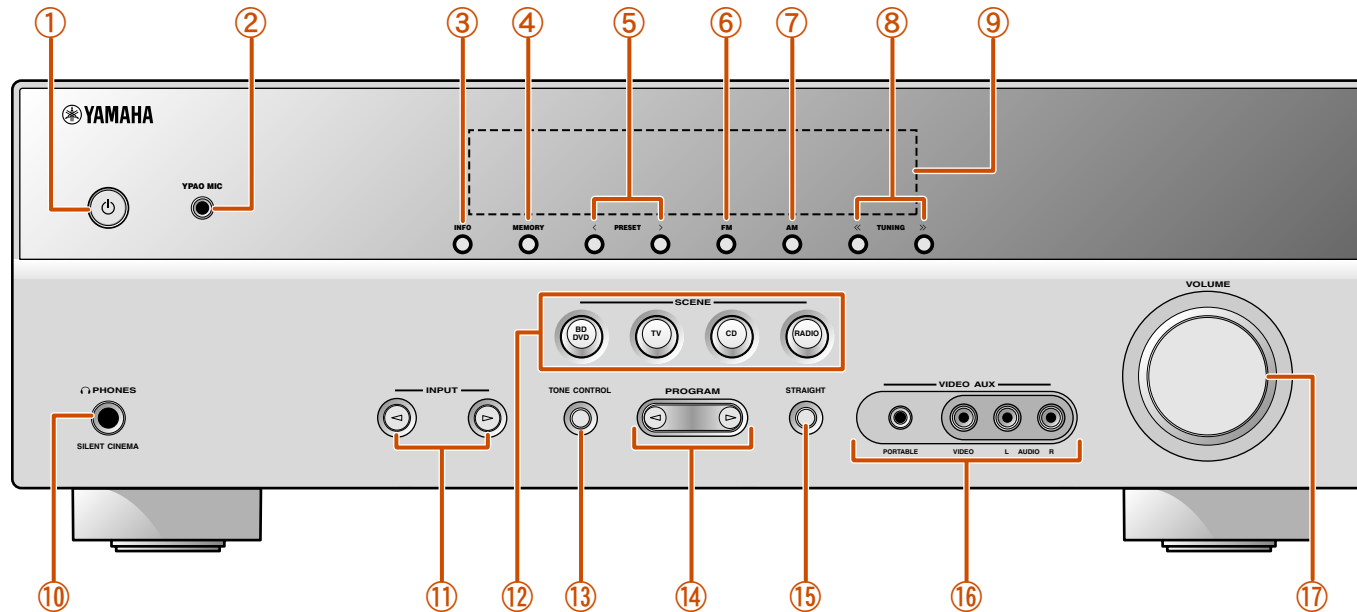

 1: Usable when you have selected tuner input.



Rear panel

- ① **HDMI OUT jack**
For connecting an HDMI - compatible TV to output audio/video signals to (esp. 13).
- ② **HDMI1-4 jacks**
For connecting external components equipped with HDMI-compatible outputs to receive audio/video signals from (esp. 15).
- ③ **ANTENNA jacks**
For connecting AM and FM antennas (esp. 20).

- ④ **COMPONENT VIDEO jacks**
For connecting TV that are compatible with component video signals, using three cables to output video signal (esp. 13).
- ⑤ **AV1-5 jacks**
For connecting to external devices equipped with audio/video outputs so that this unit can receive audio/video signals (esp. 16, p. 17).
- ⑥ **AV OUT jacks**
For outputting audio/video signals received when analog inputs (AV3-5 or AUDIO1-2) are selected (esp. 19).
- ⑦ **AUDIO1-2 jacks**
For connecting to external components equipped with analog audio outputs to input sound into this unit (esp. 18).

- ⑧ **MONITOR OUT jack**
For connecting a TV capable of receiving video input, and outputting video signals to it (esp. 14).
- ⑨ **AUDIO OUT jacks**
For outputting audio signals received when analog inputs such as the AV5 or AUDIO1-2 jacks are selected (esp. 19).
- ⑩ **SUBWOOFER jack**
For connecting a subwoofer with a built-in amplifier (esp. 11).
- ⑪ **SPEAKER terminals**
For connecting the front, center, and surround speakers (esp. 11).
- ⑫ **Power cord**
For connecting this unit to an AC wall outlet.

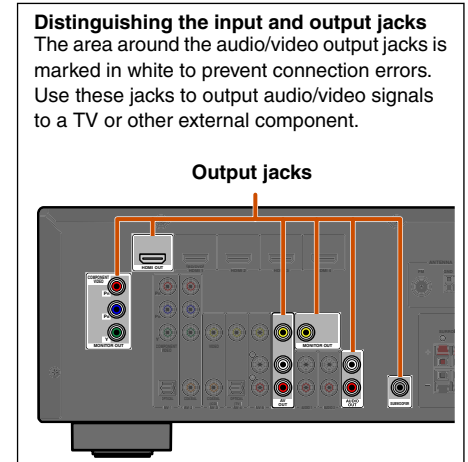
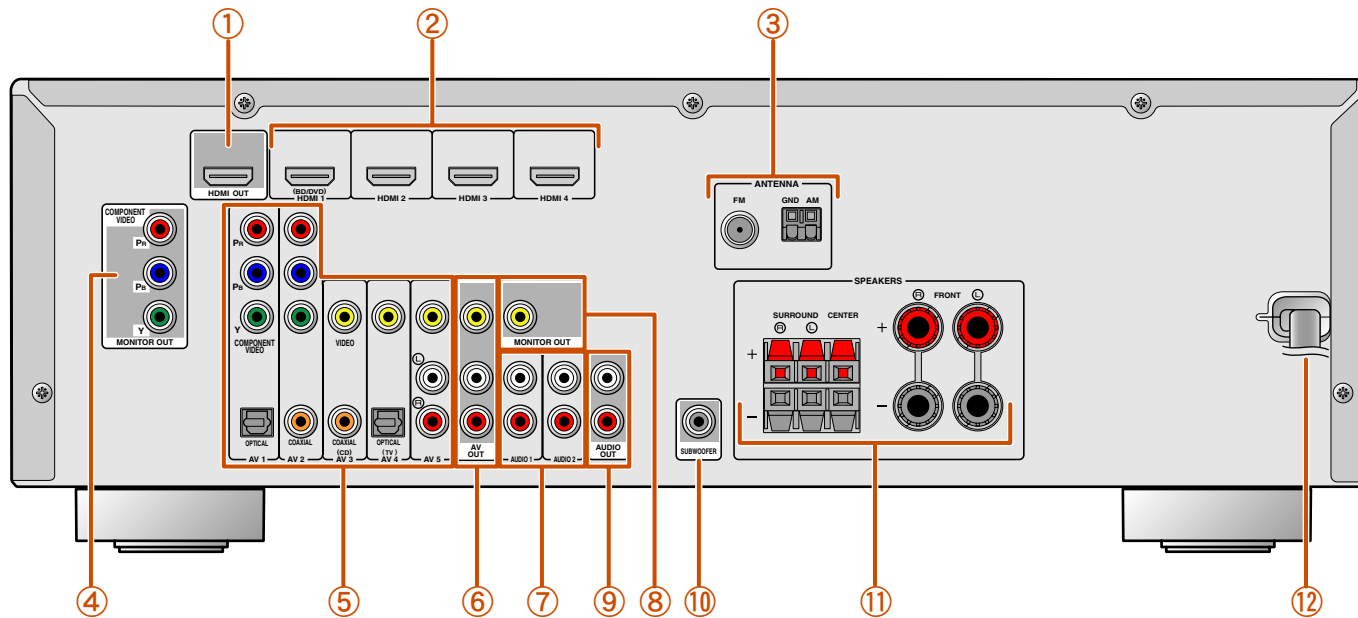

Front panel display

- ① **HDMI indicator**
Lights up during normal HDMI communication when any of the HDMI 1-4 inputs are selected.
- ② **CINEMA DSP indicator**
Lights up when a sound field effect that uses CINEMA DSP technology is selected.
- ③ **Tuner indicator**
Lights up when receiving an FM/AM broadcast.
- ④ **SLEEP indicator**
Lights up when the sleep timer is activated (see p. 8).
- ⑤ **MUTE indicator**
Flashes when audio is muted.
- ⑥ **VOLUME indicator**
Displays the current volume level.

- ⑦ **Cursor indicators**
Light up if corresponding cursors on the remote control are available for operations.
- ⑧ **Multi information display**
Displays a range of information on menu items and settings.
- ⑨ **Speaker indicators**
Indicate speaker terminals from which signals are output.

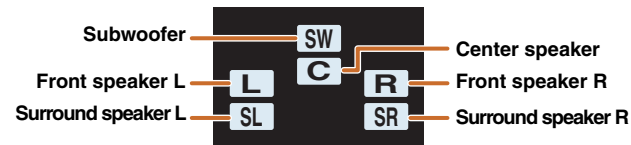

Changing the front panel display

The front panel can display sound field programs and surround decoder names as well as the active input source. Press **5** **INFO** repeatedly to cycle through input source → sound field program → surround decoder in order. 1

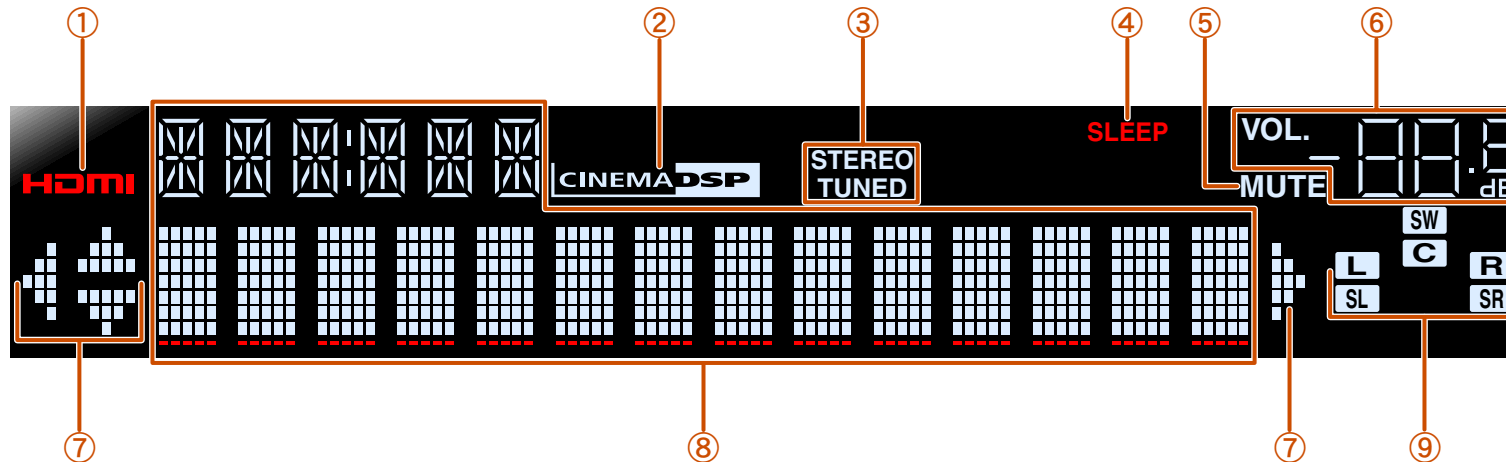
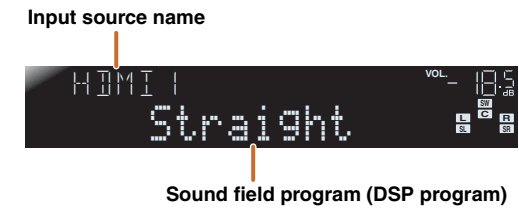

1: While selecting a tuner input, the FM/AM frequency is displayed instead of the input source.

Remote control

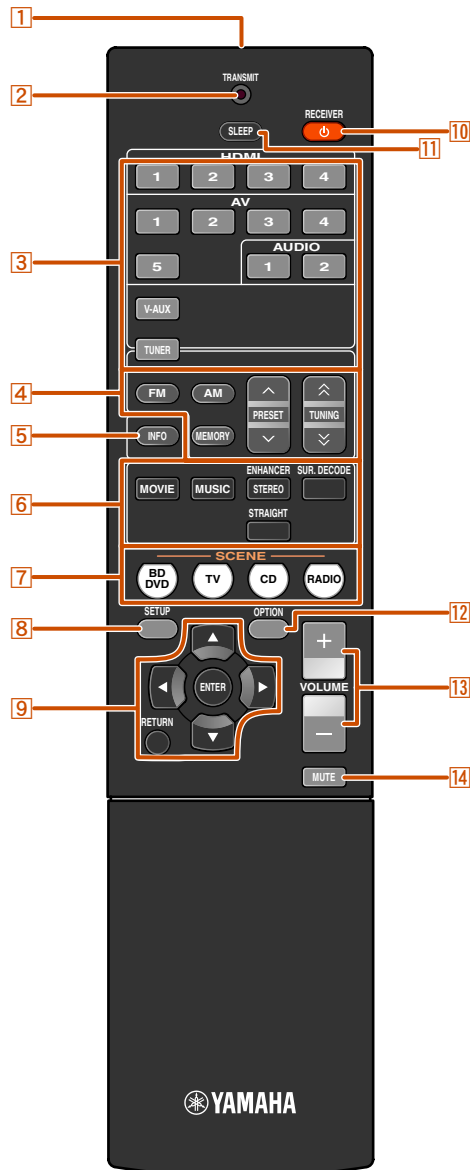

- 1 Remote control signal transmitter**
Transmits infrared signals.
- 2 TRANSMIT**
Lights up when a signal is output from the remote control.
- 3 Input selector**
Select an input source on this unit from which to playback.

HDMI1-4	HDMI1-4 jacks
AV1-5	AV1-5 jacks
AUDIO1-2	AUDIO1-2 jacks
V-AUX	Front panel VIDEO AUX jacks
TUNER	FM/AM tuner
- 4 Tuner keys**
Operates the FM/AM tuner. These keys are used when using the tuner input.

FM	Sets the FM/AM tuner band to FM.
AM	Sets the FM/AM tuner band to AM.
MEMORY	Presets radio stations.
PRESET \wedge / \vee	Selects a preset station.
TUNING \wedge / \vee	Changes tuning frequencies.
- 5 INFO**
Cycles the information displayed on the front panel display (the name of the currently selected input source, the sound field program, the surround decoder, the FM/AM tuner frequency, etc.) ([p. 7](#)).
- 6 Sound selection keys**
Switch between the sound field effect (sound field program) you are using and the surround decoder ([p. 26](#)).
- 7 SCENE**
Switches the input source and the sound field program with a single button ([p. 26](#)). Press this key when this unit is in standby mode to switch on the unit.
- 8 SETUP**
Displays a detailed Setup menu for this unit ([p. 36](#)).
- 9 Cursor** $\triangle / \nabla / \triangleleft / \triangleright$, **ENTER**, **RETURN**

Cursor $\triangle / \nabla / \triangleleft / \triangleright$	Select menu items and change settings when settings menus, etc are displayed.
ENTER	Confirms a selected item.
RETURN	Returns to the previous screen when setting menus are displayed, or ends the menu display.
- 10 RECEIVER** ϕ (**RECEIVER Power**)
Switches this unit between on and standby modes.

- 11 SLEEP**
Sets this unit to place itself in standby mode automatically after a specified period of time has elapsed (sleep timer). Press this key repeatedly to set the time for the sleep timer function. The front panel display indicator lights up when the sleep timer is activated.

- 12 OPTION**
Displays the Option menu for each input source ([p. 34](#)).
- 13 VOLUME +/-**
Adjusts the volume level ([p. 25](#)).
- 14 MUTE**
Turns the mute function of the sound output on and off ([p. 25](#)).

CONNECTIONS

Connecting speakers

This unit uses acoustic field effects and sound decoders to bring you the impact of a real movie theater or concert hall. These effects will be brought to you with ideal speaker positioning and connections in your listening environment.

Speaker channels and functions

Front left and right speakers

The front speakers are used for the front channel sounds (stereo sound) and effect sounds.

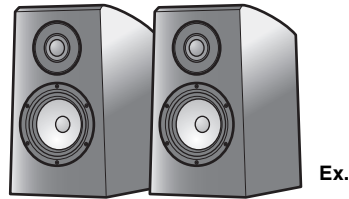

Front speaker layout:

Place these speakers at an equal distance from the ideal listening position in the front of the room.

When using a projector screen, the appropriate top positions of the speakers are about 1/4 of the screen from the bottom.

Center speaker

The center speaker is for the center channel sounds (dialog, vocals, etc.).



Center speaker layout:

Place it halfway between the left and right speakers. When using a TV, place the speaker just above or just under the center of the TV with the front surfaces of the TV and the speaker aligned.

When using a screen, place it just under the center of the screen.

Surround left and right speakers

The surround speakers are for effect and vocal sounds with the 5.1-channel speakers providing rear-area sounds.

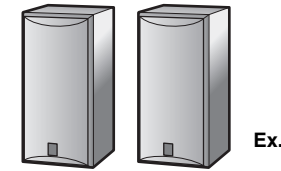

Surround speaker layout:

Place the speakers at the rear of the room on the left and right sides facing the listening position. They should be placed between 60 degrees and 80 degrees from the listening position and with the speaker tops at a height of 1.5 – 1.8 m from the floor.

Subwoofer

The subwoofer speaker is used for bass sounds and low-frequency effect (LFE) sounds included in Dolby Digital and DTS. Use a subwoofer that is equipped with an internal amplifier.

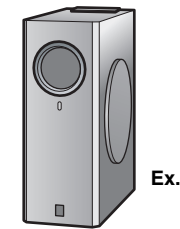

Subwoofer speaker layout:

Place it exterior to the front left and right speakers facing slightly inward to reduce echoes from the wall.

Speaker layout

5.1-channel speaker layout (5 speakers + subwoofer)

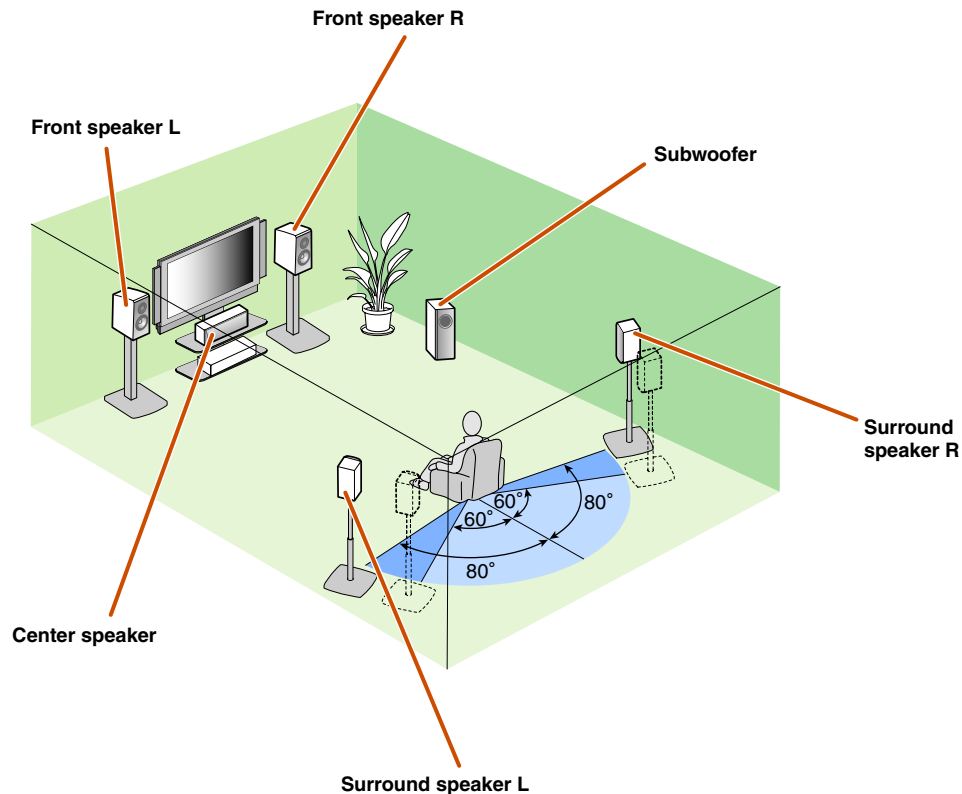

- Connect at least two speakers (front left and right).
- If you cannot connect all five speakers, give priority to the surround speakers.
- The surround speakers should be placed between 60 degrees and 80 degrees from the listening position.

■ CRT monitors

We recommend that you use magnetically shielded speakers to avoid video distortion, especially for the front and center speakers near the screen.

If your screen still gets interference from magnetically shielded speakers, move the speakers farther away from your TV.

Connecting speakers

Connect your speakers to their respective terminals on the rear panel.

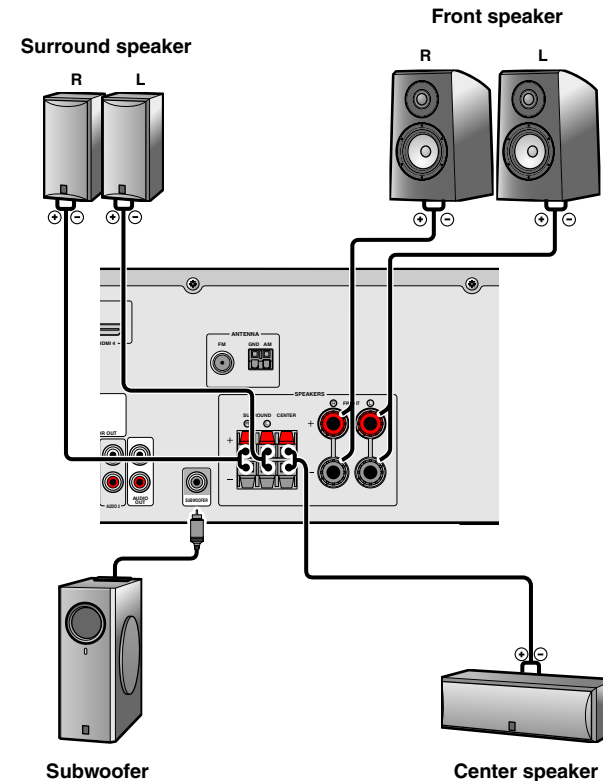

CAUTION

- Remove the AC power cord of this unit from the power outlet before connecting the speakers.
- Generally speaker cables consist of two parallel insulated cables. One of these cables is a different color, or has a line running along it, to indicate different polarity. Insert the different colored (or lined) cable into the “+” (positive, red) terminal on this unit and the speakers, and the other cable into the “-” (minus, black) terminal.
- Be careful that the core of the speaker cable does not touch anything or come into contact with the metal areas of this unit. This may damage this unit or the speakers. If the speaker cables short circuit, “CHECK SP WIRES!” will appear on the front panel display when this unit is switched on.

■ Connecting front speakers

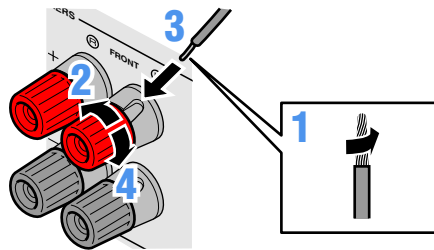

- 1** Remove approximately 10mm of insulation from the ends of the speaker cables, and twist the bare wires of the cables together firmly so that they will not cause short circuits.
- 2** Loosen the speaker terminals.
- 3** Insert the bare wire of the speaker cable into the gap on the side of the terminal.
- 4** Tighten the terminal.

Connecting the banana plug (Except U.K., Europe, Asia and Korea models)

Tighten the knob, and then insert the banana plug into the end of the terminal.

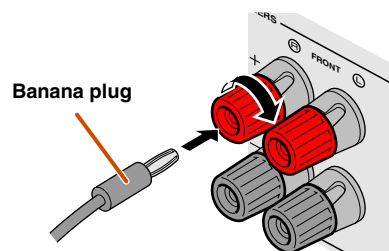

■ Connecting center speakers / surround speakers

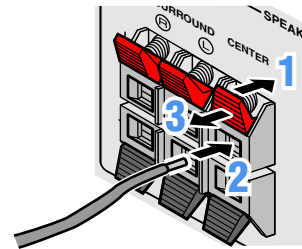

- 1** Press the tab on the speaker terminal down.
- 2** Insert the speaker cable end into the terminal.
- 3** Lift the tab to fix the speaker cable in place.

■ Connecting the subwoofer

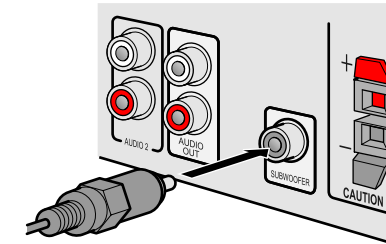

- 1** Connect the subwoofer input jack to the SUBWOOFER jack on this unit with an audio pin cable.
- 2** Set the subwoofer volume as follows.
Volume: Set to approximately half volume (or slightly less than half).
Crossover frequency (if available): Set to maximum.

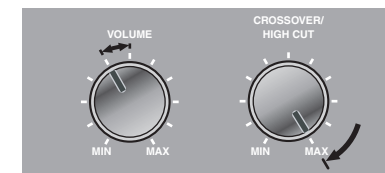

Subwoofer examples

Connecting external devices

Cable plugs and jacks

The main unit is equipped with the following input/output jacks. Use jacks and cables appropriate for components that you are going to connect.

Audio/Video jacks

HDMI jacks

Digital video and digital sound are transmitted through a single jack.
Only use an HDMI cable.

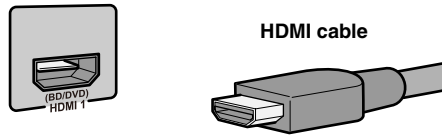

- Use a 19-pin HDMI cable with the HDMI logo.
- We recommend using a cable less than 5.0 m long to prevent signal quality degradation.

Analog video jacks

COMPONENT VIDEO jacks

The signal is separated into three components: luminance (Y), chrominance blue (PB), and chrominance red (PR).

Use component video pin cables with three plugs.

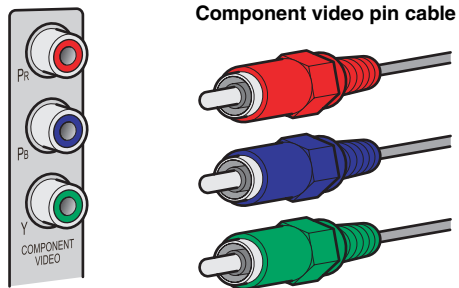

VIDEO jack

This jack transmits conventional analog video signals.

Use video pin cables.

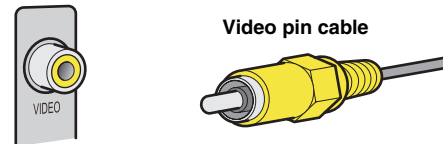

Audio jacks

OPTICAL jacks

These jacks transmit optical digital audio signals.
Use fiber-optic cables for optical digital audio signals.

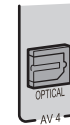

Digital audio fiber-optic cable



COAXIAL jacks

These jacks transmit coaxial digital audio signals.
Use pin cables for digital audio signals.



Digital audio pin cable

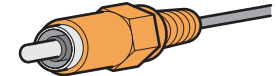

AUDIO jacks

These jacks transmit conventional analog audio signals.

Use stereo pin cables, connecting the red plug to the red R jack, and the white plug to the white L jack.



Stereo audio pin cable

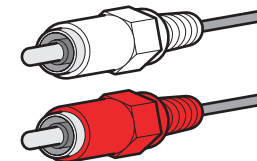

PORTABLE jack

This jack transmits conventional analog audio signals.

Use a stereo mini-plug cable when connecting.

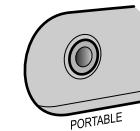

Stereo mini-plug cable

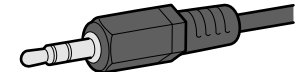

Connecting a TV monitor

This unit is equipped with the following three types of output jack for connection to a TV. HDMI OUT, COMPONENT VIDEO or VIDEO. Select the proper connection according to the input signal format supported by your TV.

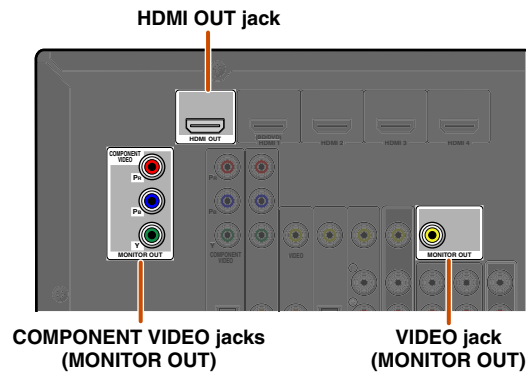

This unit will receive HDMI, component, or video signals in the same format as transmitted by the output devices.

For example, these three output devices must be connected to the monitor by matching input/output jacks and cables, and then you must change the TV's input mode to the proper setting.

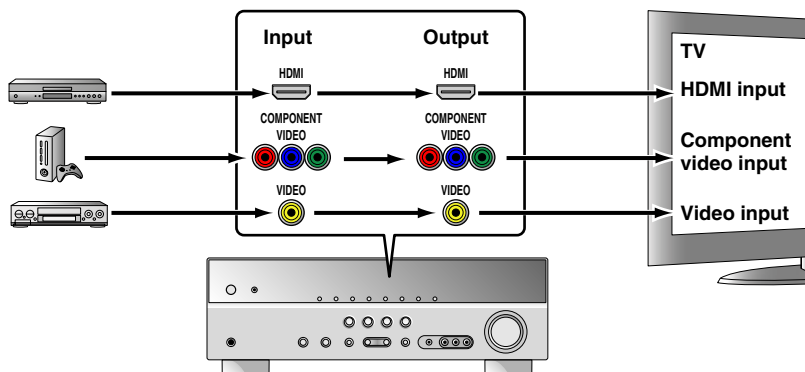

Connecting an HDMI video monitor

Connect the HDMI cable to the HDMI OUT jack.

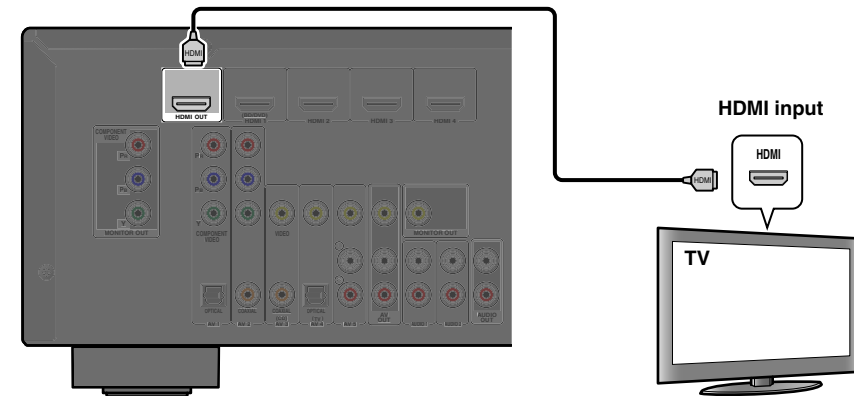

- Use a 19-pin HDMI cable with the HDMI logo.
- We recommend using a cable less than 5.0 m long to prevent signal quality degradation.

Connecting a component video monitor

Connect the component video cable to the COMPONENT VIDEO (MONITOR OUT) jacks.

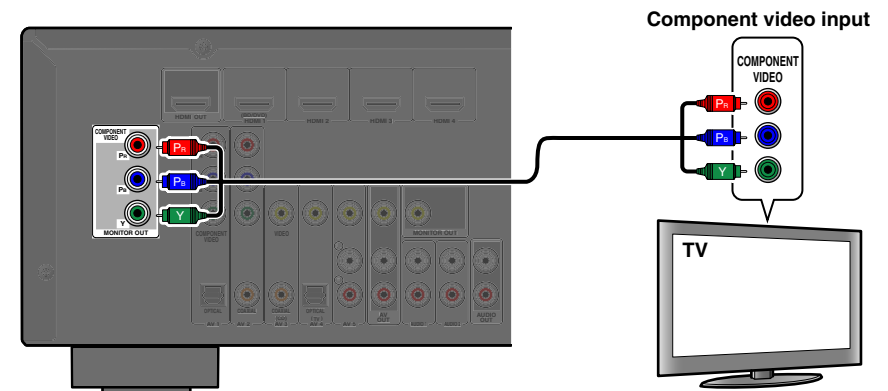

■ Connecting a video monitor

Connect the video pin cable to the VIDEO (MONITOR OUT) jack.

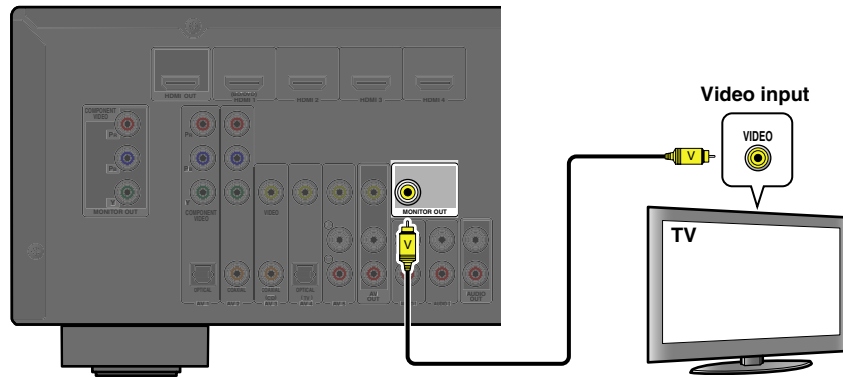

■ Listening to TV audio

To transmit sound from the TV to this unit, connect its AV1-5 or AUDIO1-2 jacks to the TV's AUDIO OUT jacks.

If the TV supports optical digital audio output, we recommend that you connect the TV audio output to the receiver's AV4 jack. Connecting to AV4 allows you to switch the input source to AV4 with just a single key operation using the SCENE function ([see p. 26](#)).

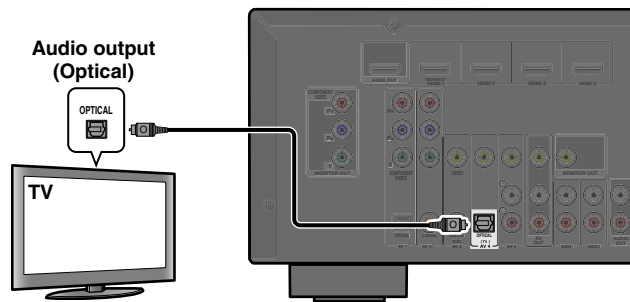

Connecting BD/DVD players and other devices

This unit has the following input jacks. Connect them to the appropriate output jacks on the external components.

Input jack	Video input	Audio input
HDMI1	HDMI	HDMI
HDMI2	HDMI	HDMI
HDMI3	HDMI	HDMI
HDMI4	HDMI	HDMI
AV1	Component video	Optical
AV2	Component video	Coaxial digital
AV3	Video	Coaxial digital
AV4	Video	Optical
AV5	Video	Analog (Stereo)
AUDIO1	---	Analog (Stereo)
AUDIO2	---	Analog (Stereo)
VIDEO AUX	Video	Analog (Stereo)

Connecting BD/DVD players and other devices with HDMI

Connect the device with an HDMI cable to one of the HDMI1-4 jacks. Select the HDMI input (HDMI1-4) that the external device is connected to for playback.

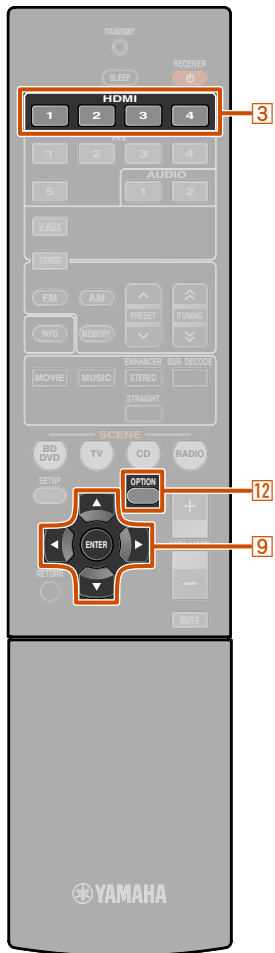

- 3 Input selector
- 9 Cursor ▾ / ◀▶
- 9 ENTER
- 12 OPTION

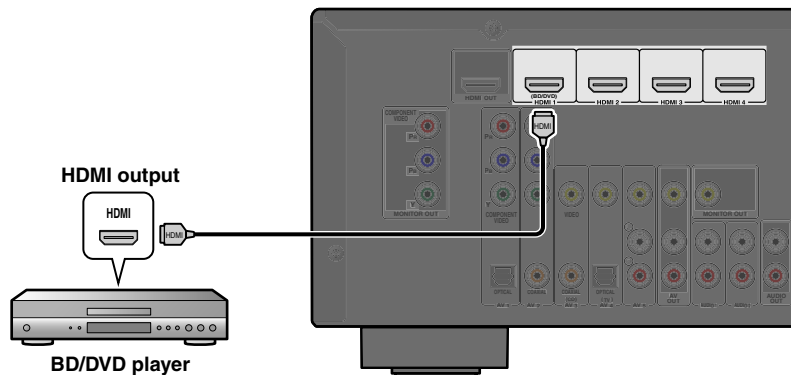

Receiving audio from other input sources

This unit can use the AV1-5 or AUDIO1-2 input jacks to receive audio signals from other audio input sources.

For example, if an external device cannot produce audio signals from an HDMI jack, use the following method to change the audio input.

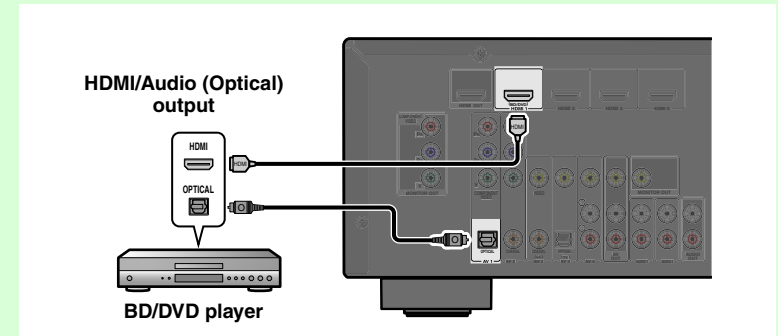

- 1 Use the 3 Input selector to select the desired HDMI input source.
 - 2 Press 12 OPTION to display the Option menu. 💡1
 - 3 Press 9 Cursor ▾ until "Audio In" is displayed, and then press 9 ENTER.
 - 4 Press 9 Cursor ◀▶ to select the audio input source.
- HDMI 1 VOL 10.5 dB

Audio In AV1

If you have selected AV1 input audio (optical digital)
- 5 Once you have completed the setup, press 12 OPTION to close the Option menu.

💡 1: See the section on "Configuring the settings specific for each input source (Option menu)" for details on the Option menu (p. 34).

■ Connecting BD/DVD players and other devices with component cables

Connect the device with a component video cable to one of the AV1-2 input jacks.

Using optical digital audio output sources

Select the AV1 input that the external device is connected to for playback.

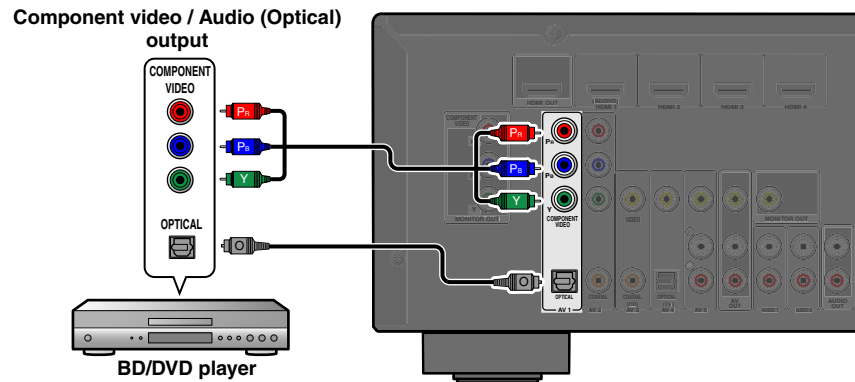

Using coaxial digital audio output sources

Select the AV2 input that the external device is connected to for playback.

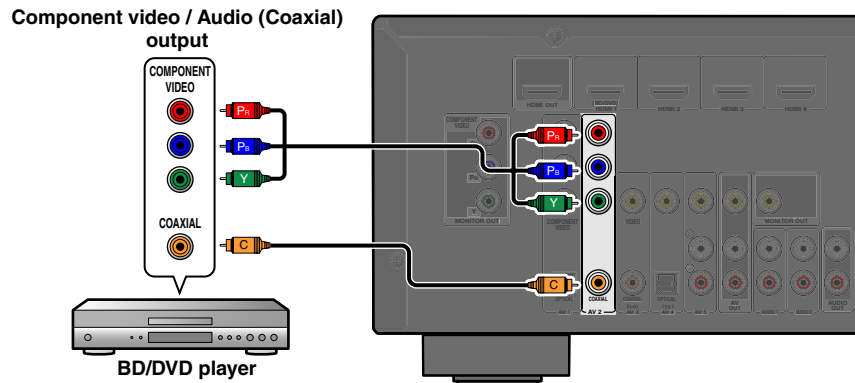

■ Component connections to analog audio output devices

Component video / Audio output

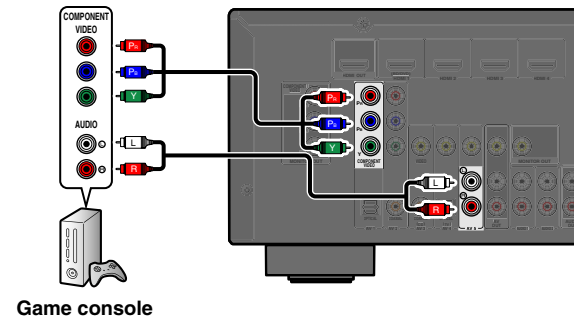

You can use the video input from the AV1-2 jacks in combination with the audio input from other AV inputs or AUDIO1-2.

When connecting these devices, select the AV3-5 or the AUDIO1-2 jacks as the audio input for AV1 or AV2. See “Receiving audio from other input sources” (p. 15) for detailed setup guidance.

Select the AV input source (AV1-2) that is connected by component video cable to the external device for playback.



Connecting BD/DVD players and other devices with video cables

Connect the external device with a video pin cable to one of the AV3-5 input jacks.

Using optical digital audio output sources

Select the AV4 input that the external device is connected to for playback.

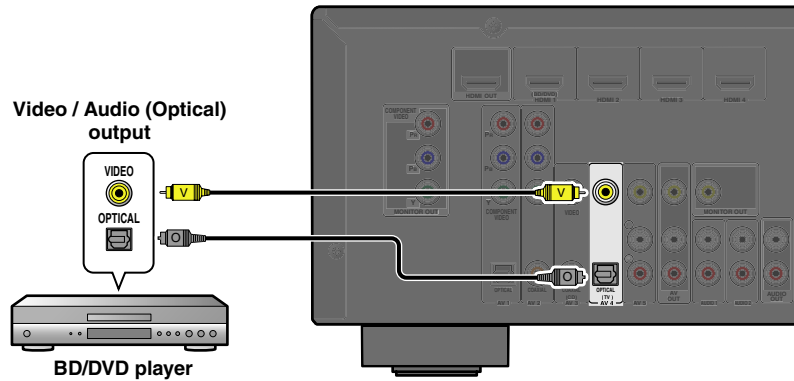

Using analog stereo audio output sources

Select the AV5 input that the external device is connected to for playback.

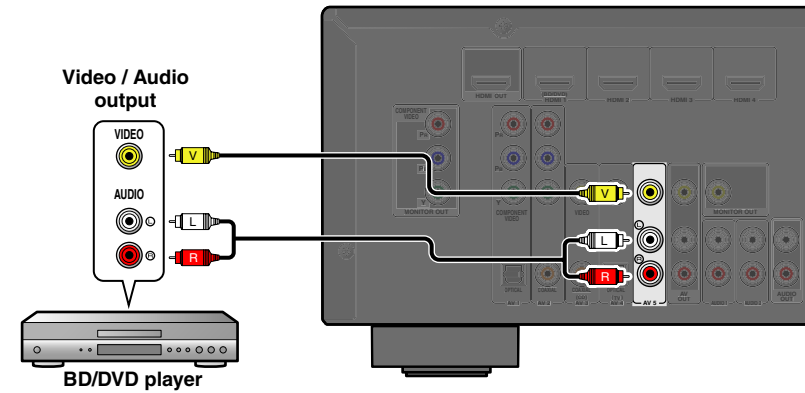

Using coaxial digital audio output sources

Select the AV3 input that the external device is connected to for playback.

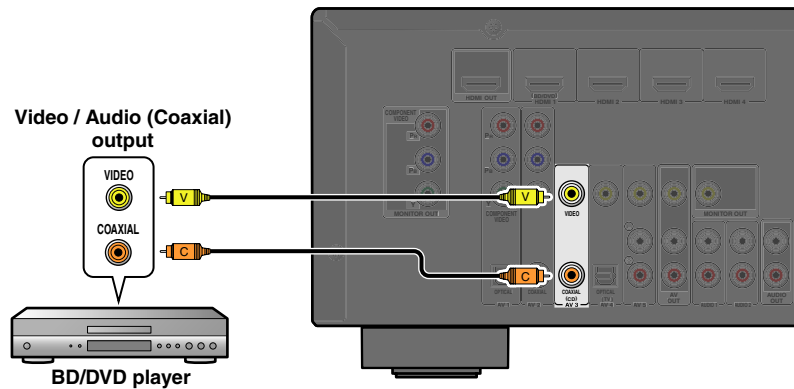

Connecting CD players and other audio devices

Using analog stereo output sources

Select the audio input (AUDIO1-2) that the external device is connected to for playback.

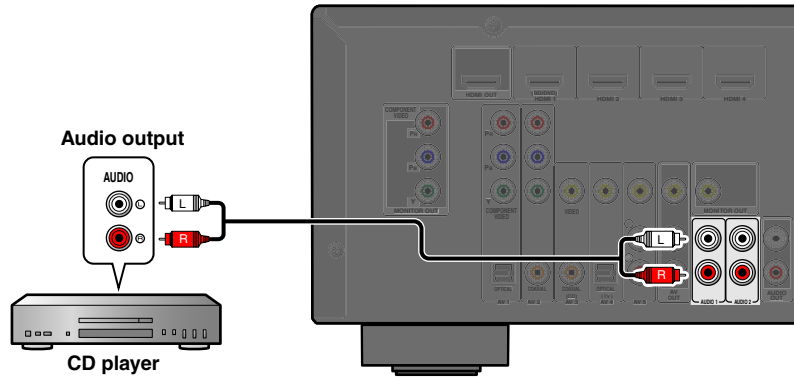

Using optical digital output sources

Select the AV input (AV1 or AV4) that the external device is connected to for playback.

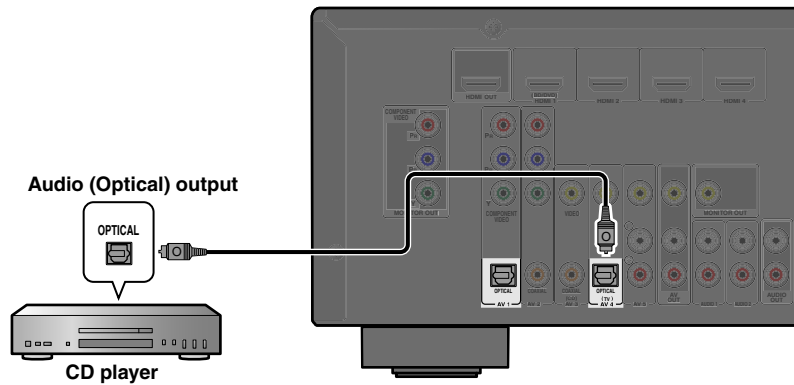

Using coaxial digital output sources

Select the AV input (AV2 or AV3) that the external device is connected to for playback.

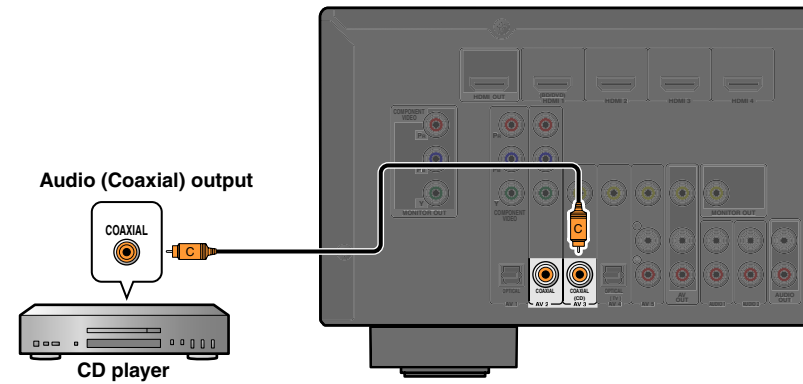

We recommend connecting audio devices with an coaxial digital output to the AV3 coaxial digital jack on this unit. This connection allows you to switch to the AV input 3 just by pressing the “CD” SCENE key ([see p. 26](#)).

Connecting video cameras and portable audio players

Use the VIDEO AUX jacks on the front panel to temporarily connect video cameras, game consoles, or portable audio devices to the receiver.

Select the V-AUX input to use these connected devices.

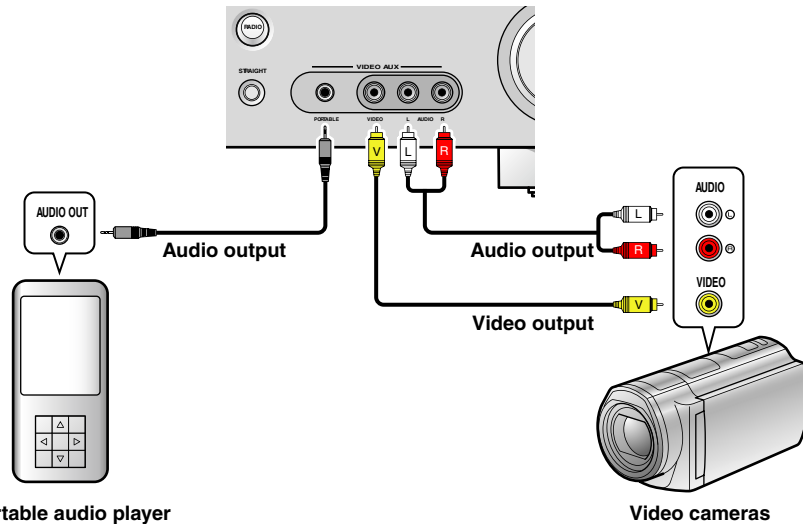

- Be sure to turn down the volume when connecting this unit and the other devices.
- When external components are connected to both the PORTABLE jack and the AUDIO jacks, the sound output from the PORTABLE jack is transmitted.

Transmitting input A/V to external devices

This receiver can transmit selected incoming analog audio/video signals to external devices through the AV OUT and AUDIO OUT jacks. You can record these input audio and video signals to VCRs or similar devices, or send them to other TVs or external devices.

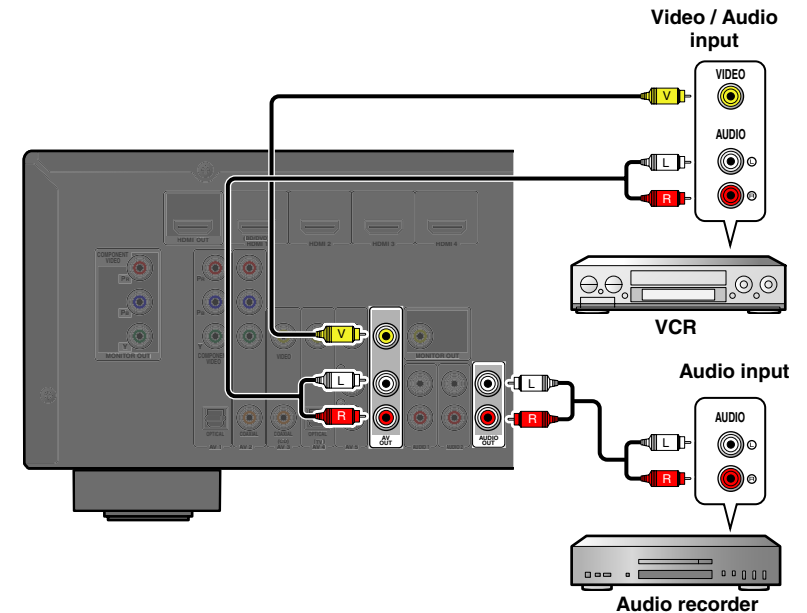

Using the AV OUT jacks

Connect these jacks to the external device's video input jack and analog audio input jacks.

Using the AUDIO OUT jacks

Connect these jacks to the external device's analog audio input jacks.

HDMI audio/video signals, component video signals, and digital audio signals cannot be transmitted from these jacks.

Connecting the FM/AM antennas

An indoor FM antenna and an AM loop antenna are included with this receiver. Connect these antennas properly to their respective jacks.

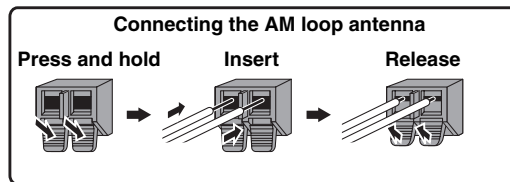
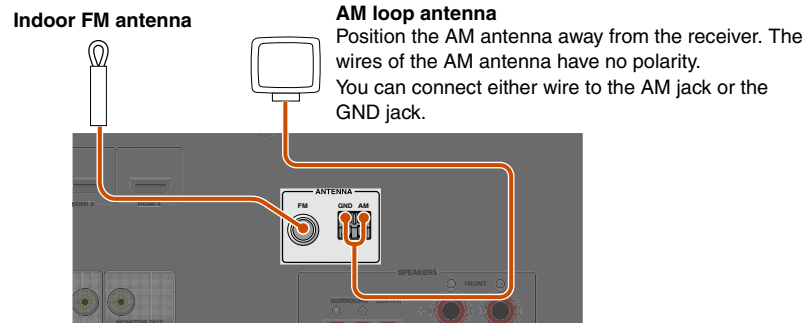

■ Improving FM reception

We recommend using an outdoor antenna. For more information, consult the nearest authorized dealer.

■ Improving AM reception

Connect this unit to an outdoor antenna with a 5-10 m vinyl-coated wire. Make sure the AM loop antenna is still connected.

Connecting the GND jack can reduce noise. Connect the jack to a store-bought ground bar or copper plate with a vinyl-covered wire and bury this new attachment in moist ground.

The GND jack is not to be connected to the ground socket of an electrical outlet.

Set up the speaker parameters automatically (YPAO)

This unit is equipped with a YPAO (Yamaha Parametric Room Acoustic Optimizer) that adjusts the status, size, and volume balance of the speakers in order to provide an optimal sound field. Using YPAO allows you to automatically configure settings for which specialist knowledge is usually needed, such as adjusting speaker output and acoustic parameters to suit your listening room (the room in which this unit is placed).  1

When you use YPAO, a test tone will be output from the speakers for approximately three minutes and acoustic measuring will be performed. When using YPAO, be careful of the following.

- The test tone is output at high volume. Please refrain from using this function at night when it may be a nuisance to others nearby.
- Please take care that the test tone does not frighten any small children.

1 Check the following before using YPAO.

This unit

- The headphones are removed.

Subwoofer

- The power is turned on.
- Volume is set to approximately half, and the cross-over frequency (if present) is set to maximum.

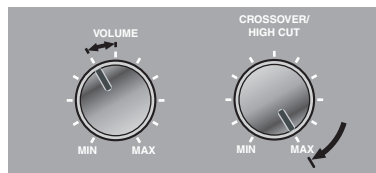

Subwoofer examples

2 Place the supplied YPAO microphone at ear height in your listening position.

Face the head of the YPAO microphone upwards.

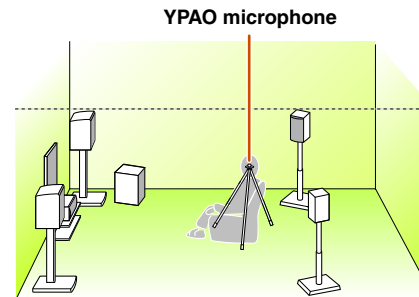

When positioning the microphone, we recommend that you use equipment that allows you to adjust the height (such as a tripod) as a microphone stand. When using a tripod, use the tripod screws to fix the microphone in place.

3 Switch this unit on.

4 Connect the YPAO microphone to the YPAO MIC jack on the front panel.

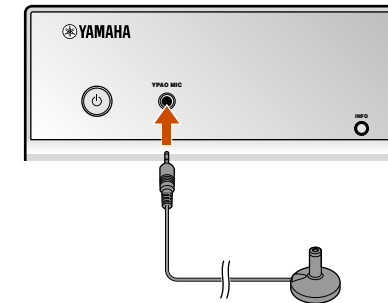

“MIC ON. YPAO START” appears on the front panel display, and then changes to display the following.  2



Continues to the next page

 1 : When you have changed the number of speakers or the locations in which they are installed, first use YPAO to adjust the speaker balance.

 2 : To cancel measurement, disconnect the YPAO microphone.

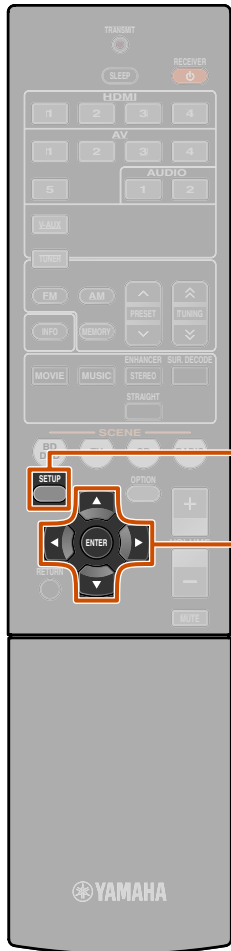

- 8 SETUP
- 9 Cursor ▽ / ◀ / ▶
- 9 ENTER

This completes preparations. To achieve more accurate results, be careful of the following when measuring.

- Measuring will take approximately three minutes. Keep the room as quiet as possible during measurement.
- Wait in the corner of the listening room during measurement or leave it entirely, to avoid becoming an obstruction between the speakers and the YPAO microphone.

5 Press 8 SETUP to start measurement.

Display during measurement



The following display appears if measurement finishes without any problems.



NOTE
When a problem occurs, an error message or report appears either during or after measurement. Use the following page as a reference to solve the problem, and carry out YPAO again.

6 Press 9 ENTER to apply the results of measurement.



You can use the following method to cancel measurement results if you want to redo the measuring. Press 9 Cursor ▽ to switch to the following display, then use 9 Cursor ◀ / ▶ to select "Cancel" and press 9 ENTER. After this operation, use the same procedure to carry out YPAO again.



7 Remove the YPAO microphone.

YPAO finishes automatically when the YPAO microphone is removed.

The YPAO microphone is sensitive to heat. When you have finished measuring, store the microphone out of direct sunlight, and away from locations that may experience high temperatures, such as on top of AV equipment.

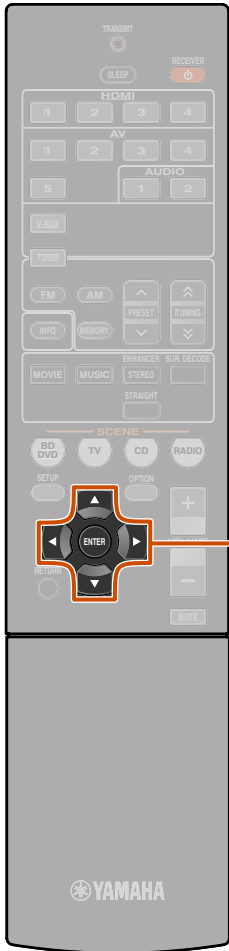

Cursor </>
 ENTER

When an error message appears during measurement

Check the content of the message from the list of messages (p. 24) to resolve the problem, and carry out the measurement process again.



Error message (example)

Check the error code that appears in the display, and carry out YPAO again by performing the following steps.

When “E-1” or “E-2” is displayed:

- 1 Press ENTER once, and then press Cursor > to select “Exit.”
- 2 Press ENTER to finish YPAO, and set the unit to standby mode.
- 3 Check that the speakers are properly connected.
- 4 Turn on the unit, and then carry out YPAO again.

When “E-5” to “E-9” is displayed:

- 1 Check that the environment is suitable for accurate measurement.
- 2 Press ENTER to switch the display.
- 3 Check that “Retry” is selected, and then press ENTER to carry out YPAO again.

When “E-10” is displayed:

- 1 Press ENTER once, and then press Cursor > to select “Exit.”
- 2 Press ENTER to finish YPAO.
- 3 Switch the unit to standby mode.
- 4 Turn on the unit again, and then carry out YPAO.

When a warning message appears after measurement

Check the content of the message from the list of messages (p. 24) to resolve the problem. You can confirm the speaker that has the problem when that speaker’s indicator lights up.

NOTE

Although you can apply the results of measurement when a warning message appears, doing so will not provide optimal sound. We recommend you resolve the problem and then carry out YPAO again.



Warning message (example)

Speaker that has a problem.

When multiple warning messages appear:

Use Cursor </> to display other warning messages.

When applying the results of measurement:

Press ENTER to switch display, the use Cursor </> to select “Set” and press ENTER.

When cancelling YPAO:

Press ENTER to switch display, the use Cursor </> to select “Cancel” and press ENTER.

Message list

NOTE

If the following messages appear, resolve the problems that have occurred and carry out the measurement process again.

When a warning message appears before measurement

Connect MIC!	The YPAO microphone is not connected.	Connect the YPAO microphone to the YPAO MIC jack on the front panel.
Unplug HP!	The headphones are connected.	Remove the headphones.
Memory Guard!	The settings of this unit are protected.	Set "Memory Guard" in the Setup menu to "Off."

Error message

E-1:FRONT SP	The unit was not able to find the front channel.	Check that the left and right front speakers are connected correctly.
E-2:SUR. SP	The unit was only able to find one of side of the surround channels.	Check that the left and right front surround speakers are connected correctly.

E-5:NOISY	The noise is too loud, preventing accurate measurements from being taken.	Measure again in quiet surroundings. Turn off any devices in the room that may be emitting noise, or place them further away from the YPAO microphone. When this message is displayed, selecting "Proceed" will allow you to continue measuring. However, we recommend resolving the problem and measuring again, as continuing measurement without doing so will not give accurate results.
E-7:NO MIC	The YPAO microphone has been removed.	While measuring, take care not to touch the YPAO microphone.
E-8:NO SIGNAL	The YPAO microphone could not distinguish a test tone.	Check that the YPAO microphone has been installed correctly. Check that each speaker has been connected and installed correctly. The YPAO microphone or the YPAO MIC jack may be broken. Inquire at the retailer where you purchased this unit, or the nearest Yamaha service center.
E-9:CANCEL	You have carried out an operation that has cancelled the measuring process.	Carry out the measuring process again. Do not operate this unit by, for example, adjusting the volume.
E-10:INTERNAL	An internal error has occurred.	Carry out the measuring process again. Contact a Yamaha service center if "E-10" appears again.

Warning message

W-1:PHASE	The speakers displayed are connected with the opposite polarity. Depending on the type of speakers you are using and the environment in which you have them installed, this message may occur even if the speakers are connected correctly.	Depending on the type of speakers, "W-1" may display even if the speakers are connected correctly. Check that the speaker polarity + (plus), and - (minus) are correct. If these are connected correctly, you can use the speakers normally even this message appears.
W-2:OVER 24m (80ft)	The speakers displayed are separated from the listening position by more than 24m, and cannot be adjusted correctly.	Install the speakers with 24m of the listening point.
W-3:LEVEL	The difference each channel is too loud or too low, and cannot be adjusted correctly.	Check that all speakers are installed in the same surroundings. Check that the speaker polarity + (plus), and - (minus) are correct. We recommend the same speakers or speakers with as similar specifications as possible. Adjust the volume of the subwoofer.

If "W-2" or "W-3" appears, you can apply measurement results, but they will not give optimal results. We recommend that you resolve the problem and carry out the measurement process again.



PLAYBACK

Basic playback procedure

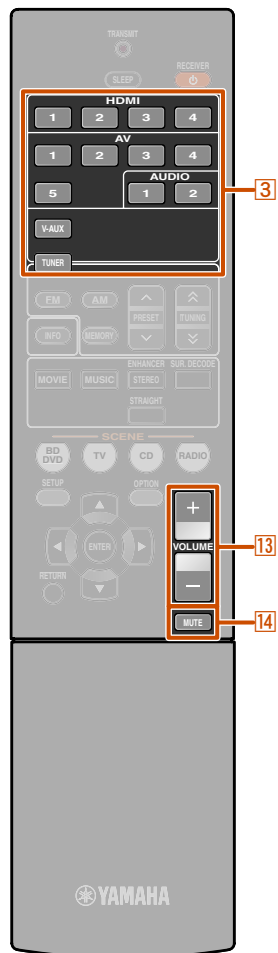

- 3** Input selector
- 13** VOLUME +/-
- 14** MUTE

- 1** Turn on external components (TV, DVD player, etc.) connected to this unit.
- 2** Turn on this unit and select the input source using **3** Input selector.
The name of the selected input source is displayed for a few seconds. 1
- 3** Play the external component that you have selected as the source input, or select a radio station on the tuner.
Refer to the instruction manuals provided with the external component for details on playback.
For details on how to tune in to FM/AM stations, refer to "FM/AM tuning" ([p. 30](#)).
- 4** Press **13** VOLUME +/- to adjust the volume.

To mute the output.

Press **14** MUTE to mute the audio output.
Press **14** MUTE again to unmute.

Adjusting high/low-frequency sound (Tone control)

You can adjust the balance of the high-frequency range (Treble) and low-frequency range (Bass) of sounds output from the front left and right speakers to obtain desired tone.

The tone control of the speakers or headphones can be set separately. Set the headphone tone control with the headphones connected.

- 1** Press TONE CONTROL on the front panel repeatedly to select "Treble" or "Bass."

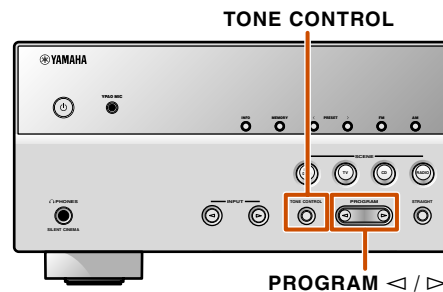

The current setting is displayed on the front panel display.



- 2** Press PROGRAM </> to adjust the output level in those frequency ranges.

Adjustable range	-10.0 dB to +10.0 dB
Adjustment increments	2.0 dB

The display returns to the previous display soon after you release the key.

If you set the balance extremely off, sounds may not match those from other channels well.

1: You can change the input source name displayed on the front panel display as necessary ([p. 42](#)).

Changing input settings with a single key (SCENE function)

This unit has a SCENE function that allows you to turn the power on and change input sources and sound field programs with one key.

Four scenes are available for different uses, such as playing movies or music. The following input sources and sound field programs are provided as the initial factory settings.

SCENE	Input	Sound field program
BD/DVD	HDMI1	Straight
TV	AV4	Straight
CD	AV3	Straight
RADIO	TUNER	5ch Enhancer

Registering input sources/sound field program

- Use **[3] Input selector** to select the input source you want to register.
- Use the **[6] Sound selection keys** to select the sound field program you want to register.

- Press the **[7] SCENE** key until “SET Complete” appears on the front panel display.



Release the key when “SET Complete” is displayed.

Enjoying sound field programs

This unit is also equipped with a Yamaha digital sound field processing (DSP) chip. You can enjoy multi-channel playback for almost any sound source using various sound field programs stored on the chip, and a range of sound decoders.

Selecting sound field programs and sound decoders

This unit offers sound field settings (sound field programs) in many different categories suitable for movies, music and other uses. Choose a sound field program that sounds best with the source you are playing back, rather than relying on the name or explanation of the program.

- Sound field programs are stored for each input source. When you change the input source, the sound field program previously selected for that input source is applied again.
- If the sampling frequency of an input source is higher than 96 kHz, this unit does not apply any sound field programs.

Selects sound field program:

MOVIE category: Press **[6] MOVIE** repeatedly

MUSIC category: Press **[6] MUSIC** repeatedly

Selects stereo reproduction:

Press **[6] STEREO** repeatedly

Selects compressed music enhancer:

Press **[6] STEREO** repeatedly

Selects surround decoder:

Press **[6] SUR. DECODE** repeatedly

Switches Straight decoding mode (p. 27):

Press **[6] STRAIGHT**

Sound field program categories



Program

- You can use the speaker indicators on the front panel display to check what speakers are currently outputting sound (p. 7).
- You can adjust sound field elements (sound field parameters) for each of the programs.

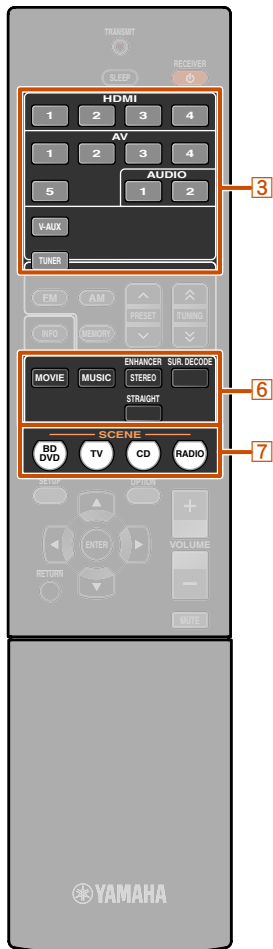

- [3] Input selector**
- [6] Sound selection keys**
- [6] MOVIE**
- [6] MUSIC**
- [6] STEREO**
- [6] SUR. DECODE**
- [6] STRAIGHT**
- [7] SCENE**



- 6 Sound selection keys
- 6 STRAIGHT
- 6 STEREO

Enjoying unprocessed playback (Straight decoding mode)

Use straight decoding mode when you want to playback sound without sound field processing. You can playback as follows in straight decoding mode.

2-channel sources such as CD

Stereo sound plays through the front left and right speakers.

Multi-channel playback sources such as BD/DVD

Plays back audio from a playback source without applying sound field effects, using an appropriate decoder to split the signal into multiple channels.

- 1 Press **6**STRAIGHT to activate the straight decoding mode.



- 2 Press **6**STRAIGHT again to exit straight decoding mode.



Previously selected program

Enjoying stereo playback

Select “2ch Stereo” from the surround field programs when you want to playback 2-channel stereo sound (from the front speakers only), regardless of the playback source.

Selecting “2ch Stereo” will playback as follows for the playback of CD and BD/DVD sources.

2-channel sources such as CD

Stereo sound plays back through the front speakers.

Multi-channel sources such as BD/DVD

Playback channels other than the front channels in the playback source are mixed with the front channels and played back through the front speakers.

- 1 Press **6**STEREO repeatedly to select “2ch Stereo.”



- 2 To deactivate stereo playback, press any of the **6**Sound selection keys to select a sound field program other than “2ch Stereo.”



Enjoying sound field programs without surround sound speakers

This unit allows you to use virtual surround speakers to enjoy sound field surround effects, even without any surround speakers (Virtual CINEMA DSP mode). You can even enjoy surround sound presence with just a minimal configuration of the front speakers only.

This unit will switch to Virtual CINEMA DSP mode automatically when surround speakers are unavailable. 🌟1

Enjoying sound field programs with headphones

Even when headphones are connected, you can enjoy the reproduction sound field presence with ease (SILENT CINEMA mode). 🌟2

🌟1: However, Virtual CINEMA DSP mode is not available in the following conditions:

- When headphones are connected to this unit.
- When a “2ch Stereo” sound field program is selected.
- When straight decoding mode is selected.

🌟2: However, SILENT CINEMA mode is not available in the following conditions:







- When a “2ch Stereo” sound field program is selected.
- When straight decoding mode is selected.

Sound field programs

 in the table indicates the sound field program for CINEMA DSP.

Category: MOVIE

Sound field programs optimized for viewing video sources such as movies, TV programs, and games.

Standard 	This program creates a sound field emphasizing the surround feeling without disturbing the original acoustic positioning of multi-channel audio such as Dolby Digital and DTS. It has been designed with the concept of an ideal movie theater, in which the audience is surrounded by beautiful reverberations from the left, right and rear.
Spectacle 	This program represents the spectacular feeling of large-scale movie productions. It reproduces a broad theater sound field that matches cinemascope and wider-screen movies with an excellent dynamic range providing everything from very small sound effects to large, impressive sounds.
Sci-Fi 	This program clearly reproduces the finely elaborated sound design of the latest science fiction and special effects-featuring movies. You can enjoy a variety of cinematographically created virtual spaces reproduced with clear separation between dialog, sound effects and background music.
Adventure 	This program is ideal for precisely reproducing the sound design of action and adventure movies. The sound field restrains reverberations but puts emphasis on reproducing a powerful space expanded widely to the left and right. The reproduced depth is also restrained relatively to ensure the separation between audio channels and the clarity of the sound.
Drama 	This sound field features stable reverberations that match a wide range of movie genres from serious dramas to musicals and comedies. The reverberations are modest but offer an optimum 3D feeling, reproducing effects tones and background music softly but cubically around clear words and center positioning in a way that does not fatigue the listener even after long hours of viewing.
Mono Movie 	This program is provided for reproducing monaural video sources such as a classic movie in an atmosphere of a good old movie theater. The program produces the optimum expansion and reverberation to the original audio to create a comfortable space with a certain sound depth.
Sports 	This program allows the listeners to enjoy stereo sport broadcasts and studio variety programs with enriched live feeling. In sports broadcasts, the voices of the commentator and sportscaster are positioned clearly at the center while the atmosphere of the stadium expands in an optimal space to offer the listeners a feeling of presence in the stadium.

Action Game



This sound field is suitable for action games such as car racing and FPS games. It uses reflection data that limits the effects range per channel in order to offer a powerful playing environment that makes the listener feel as if they are right there by enhancing various effects tones while maintaining a clear sense of directions.







Roleplaying Game



This sound field is suitable for role-playing and adventure games. It combines the sound field effects for movies and the sound field designs for "Action Game" to represent the depth and 3D feeling of the field during play, while offering movie-like surround effects in the movie scenes in the game.

Category: MUSIC

This sound field is suitable when listening to music sources such as CDs.

Hall in Munich 	This sound field simulates a concert hall with approximately 2500 seats in Munich, using stylish wood for the interior finishing as normal standards for European concert halls. Fine, beautiful reverberations spread richly, creating a calming atmosphere. The listener's virtual seat is at the center left of the arena.
Hall in Vienna 	This is an approximately 1700-seat, middle-sized concert hall with a shoebox shape that is traditional in Vienna. Pillars and ornate carvings create extremely complex reflections from all around the audience, producing a very full, rich sound.
Chamber 	This program creates a relatively wide space with a high ceiling like an audience hall in a palace. It offers pleasant reverberations that are suitable for courtly music and chamber music.
Cellar Club 	This program simulates a live house with a low ceiling and homey atmosphere. A realistic, live sound field features powerful sound as if the listener is in a row in front of a small stage.
The Roxy Theatre 	This is the sound field of a rock music live house in Los Angeles, with approximately 460 seats. The listener's virtual seat is at the center left of the hall.
The Bottom Line 	This is the sound field at stage front in The Bottom Line, a famous New York jazz club once. The floor can seat 300 people to the left and right in a sound field offering real and vibrant sound.
Music Video 	This sound field offers an image of a concert hall for live performance of pop, rock and jazz music. The listener can indulge oneself in a hot live space thanks to the presence sound field that emphasizes the vividness of vocals and solo play and the beat of rhythm instruments, and to the surround sound field that reproduces the space of a big live hall.

Category: STEREO

Suitable for listening to stereo sources.

2ch Stereo	Use this program to mix down multi-channel sources to 2 channels. When multi-channel signals are input, they are down mixed to 2 channels and output from the front left and right speakers.
5ch Stereo 	Use this program to output sound from all speakers. When you play back multi-channel sources, this unit down-mixes the source to 2 channels, and then outputs the sound from all speakers. This program creates a larger sound field and is ideal for background music at parties, etc.

Category: ENHNCR (Compressed music enhancer)

Suitable for listening to compressed audio, such as MP3.

Straight Enhancer	Use this program to restore the original depth and dynamics of 2-channel or multi-channel to compression audio.
5ch Enhancer	Use this program to play back compression artifacts in 5-channel stereo.

Category: SUR.DEC (Surround decode mode)

Select this program to playback sources with selected decoders. You can playback 2-channel sources as 5.1-channel sound.

<input type="checkbox"/> Pro Logic	A Dolby Pro Logic decoder. Suitable for any source.
<input type="checkbox"/> PLII Movie	A Dolby Pro Logic II decoder. Suitable for viewing any movie.
<input type="checkbox"/> PLII Music	A Dolby Pro Logic II decoder. Suitable for listening to music.
<input type="checkbox"/> PLII Game	A Dolby Pro Logic II decoder. Suitable for playing games.

FM/AM tuning

When using the FM/AM tuner, adjust the direction of the FM/AM antenna connected to this unit to get the best reception.

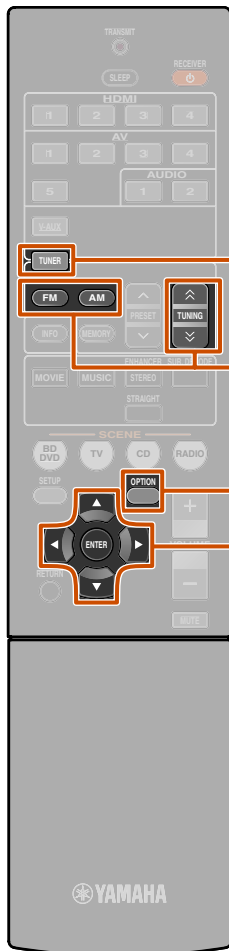

- 3** TUNER
- 4** FM
- 4** AM
- 4** TUNING \wedge / \vee
- 9** Cursor Δ / ∇ / \triangleleft / \triangleright
- 9** ENTER
- 12** OPTION

3 The FM/AM tuner of this unit provides the following two modes for tuning.

Normal tuning

4 You can tune in to a desired FM/AM station by searching or specifying its frequency.

Preset tuning (see p. 31)

12 You can preset the frequencies of FM/AM stations by registering them to specific numbers, and later just select those numbers to tune in.

Selecting a frequency for reception (Normal tuning)

1 Press **3** TUNER to switch to the tuner input.

2 Press **4** FM or **4** AM to select a band to receive.



3 Use **4** TUNING \wedge / \vee to set a frequency to receive.

4 TUNING \wedge

Increases the frequency. Press and hold this key for longer than a second to search automatically for a station on a higher frequency than the current one. 1

4 TUNING \vee

Decreases the frequency. Press and hold this key for longer than a second to search automatically for a station on a lower frequency than the current one. 1

Lights up when receiving a broadcast from a station Lights up when receiving a stereo broadcast



■ When signal reception is poor

When you are receiving an FM broadcast and cannot obtain a stable stereo broadcast, you can force this unit to receive in a monaural mode.

1 Press **3** TUNER to switch to the tuner input.

2 Press **12** OPTION to display the Option menu. 2

3 Use **9** Cursor Δ / ∇ to select "FM Mode."



4 Press **9** ENTER and use the **9** Cursor \triangleleft / \triangleright to select "Mono."



5 When setting is completed, press **12** OPTION to close the Option menu.

To return this unit to its original settings, use the same procedure to return the settings to "Stereo."

1 : When searching for a station, release the key once the search has started.

2 : See the section on "Configuring the settings specific for each input source (Option menu)" for details on the Option menu (see p. 34).

Registering and recalling a frequency (Preset tuning)

You can register up to 40 FM/AM stations as preset stations. There are two methods of presetting stations, "Auto Preset" and "Manual Preset." Use one of these methods to register stations.

■ Presetting FM stations automatically (Auto Preset)

The tuner detects FM stations with strong signals and registers up to 40 automatically.

AM stations cannot be automatically registered. Use manual station preset.

1 Press **[3]TUNER** to switch to the tuner input.

2 Press **[12]OPTION** to display the Option menu. 🌱**1**

3 Use **[9]Cursor** Δ / ∇ to select "Auto Preset."



4 Press **[9]ENTER**, then press **[4]PRESET** \wedge / \vee or **[9]Cursor** Δ / ∇ to choose the preset number from which to start the Auto Preset function.

Auto Preset will begin approximately 5 seconds after you select a preset number.

If you do not select a preset number, Auto Preset will begin approximately 5 seconds after "READY" is displayed.

Selecting a preset number



To cancel registration, press **[9]RETURN**.

During Auto Preset

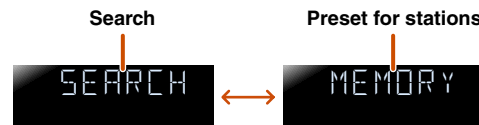

When Auto Preset is complete



The Option menu closes automatically when presetting is complete. 🌱**2**

■ Registering stations manually (Manual Preset)

Select stations by hand and register them as presets individually.

1 Tune in to the station you wish to register, referring to "Selecting a frequency for reception (Normal tuning)" (p. 30).

2 Use one of the following methods to register the station you are currently receiving.

■ Registering to a preset number to which no station is registered

Press **[4]MEMORY** for 2 seconds or longer.

The station will be registered automatically to the lowest open preset number (or the next number after the one registered most recently).

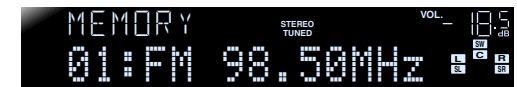

Registered frequencies

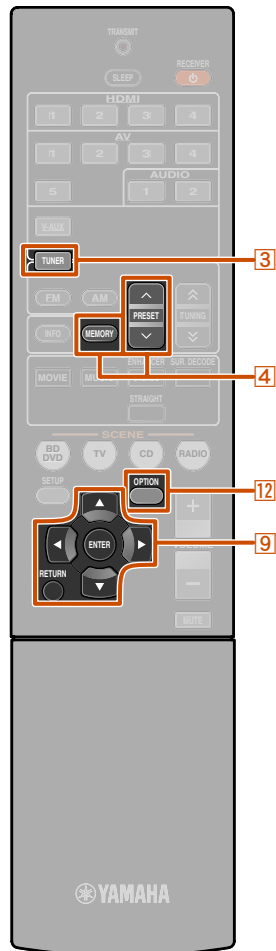

- [3] TUNER**
- [4] MEMORY**
- [4] PRESET \wedge / \vee**
- [9] Cursor Δ / ∇**
- [9] ENTER**
- [9] RETURN**
- [12] OPTION**

🌱**1** : See the section on "Configuring the settings specific for each input source (Option menu)" for details on the Option menu (p. 34).

🌱**2** : The preset with the lowest preset number will be selected automatically immediately after presetting.

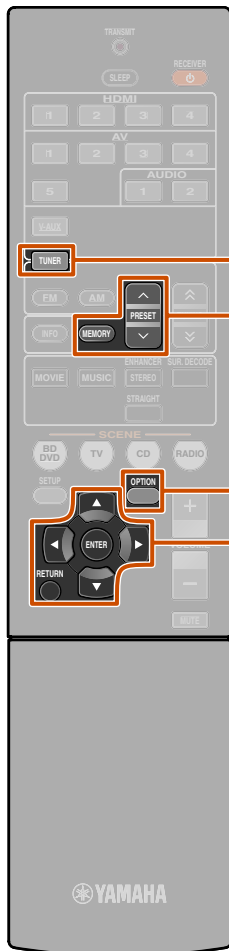

■ Designating a preset number for registration

Press **4** **MEMORY** once, to display “Manual Preset” on the front panel display. After a small wait, the preset number that the station has been registered to will appear.

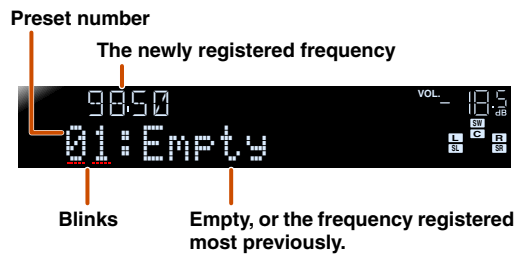

Press **4** **PRESET** **^** / **v** to select the preset to register the station to, and then press **4** **MEMORY** to register.

To cancel registration, press **9** **RETURN** or do not operate the remote control for about 30 seconds.

■ Recalling a preset station

You can call preset stations registered by automatic station preset or manual station preset. 🌱**1**

■ To select a registered station

Press **4** **PRESET** **^** / **v** to select the preset number of the station.

Clearing preset stations

1 Press **3** **TUNER** to switch to the tuner input.

2 Press **12** **OPTION** to display the Option menu. 🌱**2**

3 Use **9** **Cursor** **Δ** / **▽** to display “Clear Preset” and press **9** **ENTER**.

The number of the preset to be cleared



Press **9** **RETURN** to cancel the operation.

4 Use **9** **Cursor** **Δ** / **▽** to select the preset number you want to clear, and press **9** **ENTER** to clear it.

Repeat this operation to clear the registration of multiple numbers.

5 Press **12** **OPTION** to finish this operation.

Radio Data System tuning

Radio Data System is a data transmission system used by FM stations in many countries. This unit can receive various Radio Data System data such as “Program Service,” “Program Type,” “Radio Text,” “Clock Time” when receiving Radio Data System broadcasting stations.

The Radio Data System reception feature is only available in U.K. and Europe models.

■ Displaying the Radio Data System information

You can display the 4 types of the Radio Data System information: “Program Service,” “Program Type,” “Radio Text,” “Clock Time.”

1 Tune into the desired Radio Data System broadcasting station.

We recommend that you use the automatic preset tuning to tune into the Radio Data System broadcasting stations ([p. 31](#)).

Continues to the next page

🌱**1** : Preset numbers to which no stations are registered will be skipped. “No Presets” or “No Presets in Memory” is displayed when there are no stations are registered.

🌱**2** : See the section on “Configuring the settings specific for each input source (Option menu)” for details on the Option menu ([p. 34](#)).

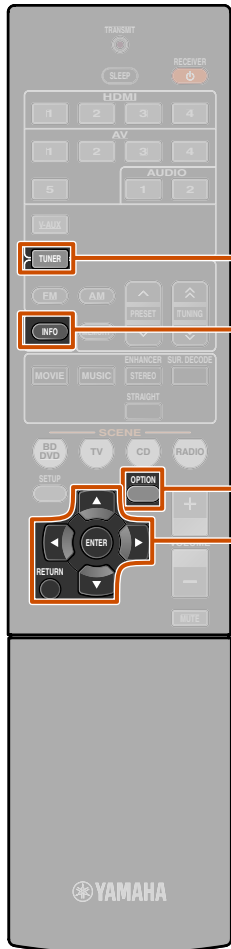

- 3 TUNER
- 5 INFO
- 9 Cursor Δ / ∇
- 9 ENTER
- 9 RETURN
- 12 OPTION

2 Press **5** INFO repeatedly until the desired information is displayed.

Information on the display changes as you press the key. The kind of information is displayed for a while and then the information is displayed. 1

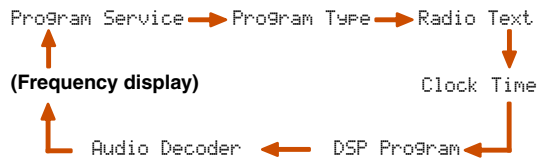

Contents of information are as follows.

Type of information	Description
Program Service	Displays the name of the Radio Data System program service currently being received.
Program Type	Displays the type of the Radio Data System program currently being received.
Radio Text	Displays the information on the Radio Data System program currently being received.
Clock Time	Displays the current time.
DSP Program	Displays the currently selected sound field program.
Audio Decoder	Displays the currently selected surround decoder.

Front panel display (When “Program Type” selected)

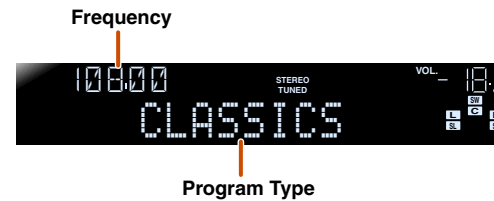

“Program Service,” “Program Type,” “Radio Text” and “Clock Type” do not appear when the radio station does not provide the Radio Data System service.

Automatic traffic information reception

When the tuner is active, this unit can automatically search for and receive transmissions from traffic information broadcast stations. To enable this function:

1 Press **3** TUNER to switch to the tuner input.

2 Press **12** OPTION to display the Option menu. 2



3 Use **9** Cursor Δ / ∇ to select “TrafficProgram.”



4 Press **9** ENTER to enable the search function.



- The transmission search will begin in approximately 5 seconds. Or, when the status indicator reads “READY,” you can begin the search immediately by pressing **9** ENTER.
- By pressing **9** RETURN right before or during a search, it will return to the Option menu.
- When the status is “READY,” use **9** Cursor Δ / ∇ to start a search in the specified direction.
 - 9** Cursor Δ : Searches upward from the current frequency.
 - 9** Cursor ∇ : Searches downward from the current frequency.

When a traffic station is found, it will appear on the display and the Option menu will close.

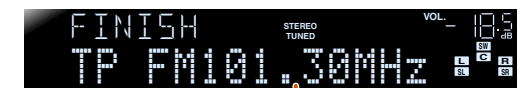

Traffic info broadcast station (Frequency)

If the receiver cannot find a traffic station, “TP Not Found” will appear on the display, and the Option menu will shortly close.

1: “PTY Wait,” “RT Wait,” or “CT Wait” may appear when Program Type, Radio Text, or Clock Time is displayed. That shows this unit is receiving data (or stopping receiving data). If the data is receivable, the corresponding information is displayed after a while.

2: See the Setting the Option menu for Each Input Source section ([p. 34](#)) for more information on the Option menu.

SETUP

Configuring the settings specific for each input source (Option menu)

This receiver has a unique option menu specific for each type of input source, such as volume trim for compatible input sources, audio/video data display for signals from external devices, and other frequently used menu items.

Option menu display and setup

1 Use the **[3] Input selector** on the remote control to select the Option menu you wish to display.

2 Press **[12] OPTION**.
The Option menu appears for the desired input source.

3 Select the desired control/setup item using **[9] Cursor Δ / ∇** and press **[9] ENTER**.
The displayed Option menu items differ depending on the input source.
For details, read the following Option menu items section.

4 Select the desired menu item (or enable a function) using **[9] Cursor Δ / ∇ / \leftarrow / \rightarrow** and **[9] ENTER**.

Parameters of the selected item are displayed. The parameters you can set differ depending on the menu items.

- You can also use **[9] RETURN** to return to the previous screen or close the Option menu.
- Certain selected menu items may automatically close the Option menu when their functions are enabled.

5 To close the Option menu, press **[12] OPTION**.

For a few seconds after closing the Option menu, the remote control keys may not function. If this occurs, reselect the input source.

Option menu items

The following menu items are provided for each input source.

HDMI1-4	Volume Trim	Audio In	Signal Info
AV1-2	Volume Trim	Audio In	Signal Info
AV3-4	Volume Trim	Signal Info	
AV5	Volume Trim		
AUDIO1-2	Volume Trim		
V-AUX	Volume Trim		
TUNER	Volume Trim	FM Mode	Auto Preset
		Clear Preset	TrafficProgram

Adjusting volume between input sources

Volume Trim

Input source: All

Reduces any change in volume when switching between input sources by correcting volume differences in each input source. You can adjust this parameter for each input source.

Adjustable range	-6.0 dB to 0.0 dB to +6.0 dB
Default setting	0.0 dB
Adjustment increments	0.5 dB steps

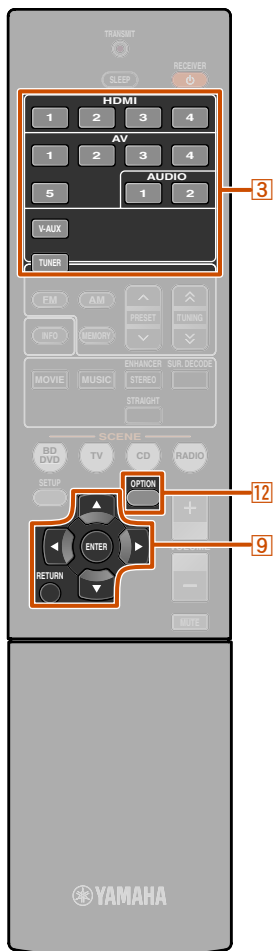

- [3] Input selector**
- [9] Cursor Δ / ∇ / \leftarrow / \rightarrow**
- [9] ENTER**
- [9] RETURN**
- [12] OPTION**



Combining HDMI/AV1-2 input source video and audio

Audio In

Input source: HDMI1-4, AV1-2

Combines video from HDMI or AV input sources with analog/digital audio inputs in situations such as:

- an external device is connected with an HDMI cable but cannot transmit audio through HDMI
- an external device with component video output and analog audio output (such as certain game consoles) are connected to the system

Inputs that change the audio source



Assignable audio input jacks

To change assignments, select an input source (HDMI1-4 or AV1-2) as the video input first, and then select audio input jacks in this menu.

Set as follows according on the desired combination of audio input jacks.

Audio inputs	Settings method
Optical digital audio input	Select AV1 or AV4. Connect the external component audio cable to the optical jack for the selected input.
Coaxial digital audio input	Select AV2 or AV3. Connect the external component audio cable to the coaxial jack for the selected input.
Analog audio input	Select one of AV5, AUDIO1, or AUDIO2. Connect the external component audio cable to the audio jack for the selected input.

- For details of settings, refer to “Receiving audio from other input sources” (p. 15) and “Component connections to analog audio output devices” (p. 16).
- To return audio inputs to their previous settings, display this item again, and select the original input jack.

Displaying information on audio/video signals

Signal Info

Input source: HDMI1-4, AV1-4

Displays information on digital audio and video signals on the front panel display. You can display the signal information by pressing **ENTER** on the menu item and using **Cursor** Δ / ∇ .



Information

Audio information

FORMAT	Format of audio signals.
CHAN	The number of input signal channels (front/surround/LFE). For example, if input signal channels are 3 front channels, 2 surrounds and LFE, “3/2/0.1” is displayed.
SAMPL	The sampling frequency of analog-to-digital conversion.
RATE	The bit rate of input signal per second.

Video information

V IN	Format and resolution of video input signal.
V OUT	Format and resolution of video output signal.
V MSG (appears only when an error has occurred)	Error messages about HDMI signals and components. Error message HDCP Error HDCP authentication failed. Device Over The number of connected HDMI components is over the limit.

- “No Signal” is displayed when no signals are being received, and “---” is displayed if this unit cannot recognize the incoming signal.
- The bit rate may vary during playback.

Changing FM mode (Stereo/Monaural)

FM Mode

Input source: TUNER

Sets this unit to automatically match FM broadcast frequencies in stereo, or to convert the frequency to monaural (p. 30).

Automatically presetting FM radio stations

Auto Preset

Input source: TUNER

Automatically detects radio stations in the FM frequency and registers them as preset stations (p. 31).

Clearing preset FM stations

Clear Preset

Input source: TUNER

Clears the preset stations (p. 32).

Searching for traffic information

TrafficProgram

Input source: TUNER

Automatically searches for traffic information with the Radio Data System (p. 32).

Setting various functions (Setup menu)

You can configure various function settings of this unit using the Setup menu.

Setup menu display and settings

1 Press **[8] SETUP** on the remote control.



2 Use the **[9] Cursor** Δ / ∇ to select the desired menu and press **[9] ENTER**.

Setup menu categories

Speaker Setup	Manages settings for speakers.
Sound Setup	Manages settings for audio output.
Func. Setup	Manages settings to make receiver operation easier, such as input source labeling and auto-standby functions.
DSP Parameter	Sets parameters for sound field programs.
Memory Guard	Protects settings against accidental alteration.



Ex: Sound Setup menu

3 Use **[9] Cursor** Δ / ∇ to navigate the submenus to find the desired setting and press **[9] ENTER**.



4 When multiple items appear, use **[9] Cursor** Δ / ∇ to select the desired item.

5 Press **[9] Cursor** \leftarrow / \rightarrow to change the setting. You can change other items by repeating step 4 and 5.

You can also use **[9] RETURN** to return to the previous screen.

6 Press **[8] SETUP** to exit the Setup menu.

For a few seconds after closing the Setup menu, the remote control keys may not function. If this occurs, reselect the input source.

Setup menu items

Setup menu

Speaker Setup

- Config
 - Subwoofer
 - Front
 - Center
 - Sur. LR
 - Crossover
 - SWFR Phase
 - Extra Bass
- Level (speakers)
- Distance (unit and speakers)
- Equalizer (speakers and frequency bands)
- Test Tone

Sound Setup

- Lipsync
 - HDMI Auto
 - Auto
 - Manual
- Adaptive DRC
- D.Range
- Max Volume
- Init. Volume
- HDMI Audio Out

Func. Setup

- Input Rename
- AutoPowerDown
- Dimmer

DSP Parameter

Memory Guard

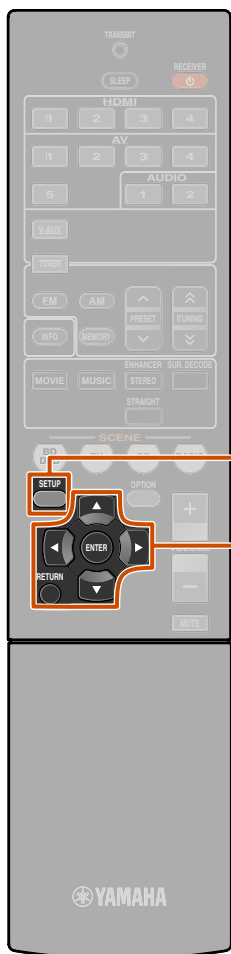

- [8] SETUP**
- [9] Cursor** $\Delta / \nabla / \leftarrow / \rightarrow$
- [9] ENTER**
- [9] RETURN**

Manages settings for speakers



Speaker Setup submenu

Config	Manually manages speaker configuration, such as speaker size (sound production capacity), and bass audio processing.
Level	Manually adjusts the volume of each speaker.
Distance	Manually adjusts the output of each speaker based on distance to the listening point.
Equalizer	Selects an equalizer to adjust speaker output characteristics.
Test Tone	Generates test tones.

Manual speaker setup

Config

Adjusts the output characteristics of the speakers based on manually set parameters.

In the Config submenu, you can select the speaker size characteristic (Large or Small). Select the size (sound reproduction capacity) that matches your speakers.

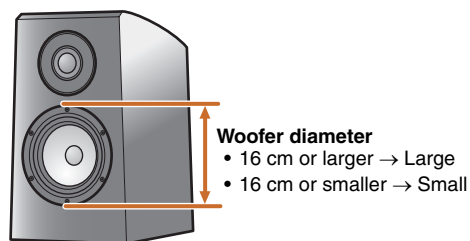

When speaker size is set to “Small,” low-frequency components of the speakers that you configured are produced from the subwoofer (or from the front speakers if there is no subwoofer).

Subwoofer

Confirms the subwoofer.

Yes (Default)	Select this when you have a subwoofer connected. During playback, the subwoofer will produce audio from the LFE (low-frequency effect) channel and bass audio from other channels. 🌟1
None	Select this when you do not have a subwoofer connected. The front speakers will produce audio from the LFE (low-frequency effect) channel and bass frequency audio from other channels.

Front

Selects the size (sound reproduction capacity) of the front speakers. 🌟2

Small (Default)	Select this for small speakers. The subwoofer will produce front channel low-frequency components. 🌟3
Large	Select this for large speakers. The front speakers will produce all of the front channel frequency components.

Center

Selects the size of the center speakers.

None	Select this when there is no center speaker. The front speakers will produce center channel audio.
Small (Default)	Select this when a small center speaker is connected.
Large	Select this when a large center speaker is connected.

Sur. LR

Selects the size of the surround speakers.

None	Select this when no surround speakers are connected. The front speakers will produce surround channel audio signals.
Small (Default)	Select this when the surround speakers are small.
Large	Select this when the surround speakers are large.

🌟1: Enabling the “Extra Bass” setting allows both the subwoofer and the front speakers to produce bass audio.

🌟2: When “Subwoofer” is set to “None,” you can only choose “Large.” If the front speaker setting is “Small” and you change “Subwoofer” to “None,” it will automatically change to “Large.”

🌟3: Enabling the “Crossover” setting allows you to set the frequency components of audio signals transmitted from the front speakers to the subwoofer.

Crossover

Sets the lower limit of low-frequency component output from speakers set to “Small.”

Audio with a frequency below that limit will be produced from the subwoofer or the front speakers. 1

40Hz	110Hz
60Hz	120Hz
80Hz (Default)	160Hz
90Hz	200Hz
100Hz	

SWFR Phase

Sets the phase of the subwoofer if the bass audio is lacking or unclear.

NRM (Default)	Does not change the subwoofer phase.
REV	Reverses the subwoofer phase.

Extra Bass

Allows the front channel low-frequency components to be produced exclusively by the subwoofer, or by both the subwoofer and the front speakers.

On	The subwoofer and the front speakers produce the front channel low-frequency components.
Off (Default)	Depending on the size of the front speakers, either the front speakers or the subwoofer produce the front channel low-frequency components.

When the “Subwoofer” is set to “None,” the “Extra Bass” setting is disabled.

Controlling the volume of each speaker

Level

Separately adjusts the volume of each speaker. Use Cursor / to select the desired speaker and adjust the volume with Cursor .

FL	Front speaker L
FR	Front speaker R
C	Center speaker
SL	Surround speaker L
SR	Surround speaker R
SWFR	Subwoofer

Adjustable range	-10.0 dB to +10.0 dB
Default setting	0 dB (FL / FR / SWFR) -1.0 dB (C / SL / SR)
Adjustment increments	0.5 dB

Manually setting speaker distance

Distance

Adjusts the timing at which the speakers produce audio so that sounds from the speakers reach the listening position at the same time.

Selecting adjustment units

Use Cursor / to display “Unit,” and then use Cursor / to choose the units of length (meters or feet).

Setting distances for each speaker

Use Cursor / to display the speaker you want to configure, and then use Cursor / to set the distance from the speaker to your listening position.

Unit	Selects the distance unit (meters or feet).
Front L	Front speaker L
Front R	Front speaker R
Center	Center speaker
Sur. L	Surround speaker L
Sur. R	Surround speaker R
SWFR	Subwoofer

Adjustable range	0.30 m to 24.0 m (1.0 ft to 80.0 ft)
Default setting	3.00 m (10.0 ft) (Front L/Front R/SWFR) 2.60 m (8.5 ft) (Center) 2.40 m (8.0 ft) (Sur. L/Sur. R)
Adjustment increments	0.10 m (0.5 ft)

1: If your subwoofer has a volume control or a crossover frequency control, set the crossover frequency to maximum and the volume to half (or slightly less).

Adjusting sound quality with the equalizer

Equalizer

Adjusts sound quality of tone using a parametric or graphic equalizer.

EQ Select

Select an equalizer type.

PEQ	Uses the parametric equalizer to adjust sound quality. Selecting this setting applies the tone settings obtained using YPAO (see p. 21). 
GEQ (Default)	Uses the graphic equalizer to adjust sound quality. By pressing [9]ENTER , you can adjust the characteristics of the graphic equalizer.
Off	Does not activate the equalizer.

Adjusting the graphic equalizer

1 When “EQ Select” is displayed, use **[9]Cursor </>** to select “GEQ” and press **[9]ENTER**.

2 Check that “Channel” appears and use **[9]Cursor </>** to select the speaker for which you want to adjust the equalizer.



The speaker you are adjusting

3 Press **[9]Cursor ▾** repeatedly to select the frequency you want to adjust, then use **[9]Cursor </>** to adjust the volume.

Raising volume: Press **[9]Cursor ▷**.

Lowering volume: Press **[9]Cursor ◁**.



Frequency band

Setting the volume level for the selected frequency

Frequency range	63 Hz/160 Hz/400 Hz/1 kHz/2.5 kHz/6.3 kHz/16 kHz
Adjustable range	-6.0 dB to 0 dB to +6.0 dB
Default setting	0 dB
Adjustment increments	0.5 dB

You can use **[9]Cursor △ / ▽** to select another frequency or return to step 2. Repeat steps 2-3 to adjust the tone to your liking.

4 When you have finished making adjustments, press **[8]SETUP** to close the Setup menu.

Generating test tones

Test Tone

Turns the test tone generator on or off.

Off (Default)	Does not generate test tones.
On	Generates test tones. While “On” is selected, test tones are produced constantly.

You can use the test tone in a variety of circumstances. For example, you can adjust the volume balance settings for each speaker, or whenever you adjust the settings on the internal graphic equalizer, you can listen to the actual effect while operating this unit. Turn the test tone off when you have finished making adjustments.

 **1**: Using YPAO to carry out acoustic measurement selects “PEQ” automatically. “PEQ” does not appear if the measurement process has not been carried out at least once.

Setting the audio output function of this unit



Sound Setup submenu

Lipsync	Adjusts the delay between video and audio output.
Adaptive DRC	Auto-adjusting the sound level to make even low volumes more audible.
D.Range	Selects the dynamic range adjustment method for digital audio playback.
Max Volume	Sets the maximum volume for this receiver.
Init.Volume	Sets the initial volume for when this receiver is turned on.
HDMI Audio Out	Selects audio signals received through the HDMI input jack.

Synchronizing audio/video output

Lipsync

Adjusts the delay between audio and video output (Lipsync function).

HDMI Auto

When connecting to a TV via HDMI, automatically adjusts output timing if the TV supports an automatic lipsync function.

Off (Default)	Select this when the connected TV does not support the automatic lipsync function or you do not wish to use the automatic lipsync function. Set the correction time in "Manual."
On	Select this when the TV supports the automatic lipsync function. Fine-adjust the correction time in "Auto."

Auto

Fine-adjust the audio output timing by entering the correction time provided when "HDMI Auto" is set to "On."

Adjustable range	0 ms to 240 ms
Adjustment increments	1 ms

Manual

Manually adjusts the correction time. Select this when the TV does not support the automatic lipsync function or "HDMI Auto" is set to "Off."

Adjustable range	0 ms to 240 ms
Adjustment increments	1 ms
Default setting	0 ms

Auto-adjusting the sound level to make even low volumes more audible

Adaptive DRC

Adjusts the dynamic range in conjunction with the volume level (from minimum to maximum). When you play audio at night or at low volumes, it is a good idea to set parameter to "Auto." 1

Auto	Adjusts the dynamic range automatically.
Off (Default)	Does not adjust the dynamic range automatically.

When the auto function is enabled, it adjusts the dynamic range as follows.

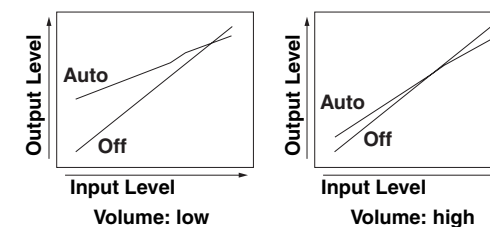

1: The Adaptive DRC setting is also effective when you use headphones.

Auto-adjusting Dolby Digital and DTS dynamic range

D.Range

Selects the dynamic range adjustment method for audio bitstream (Dolby Digital and DTS) playback.

Max (Default)	Produces audio without adjusting the dynamic range.
STD	Sets the standard dynamic range suitable for home use.
Min	Sets the dynamic range at the lowest level for playback. This is useful for low-volume audio.

Setting the maximum volume

Max Volume

Sets a maximum volume level so that the audio is not played too loudly. The default setting of +16.5 dB produces the highest volume.

Adjustable range	-30.0 dB to +15.0 dB / +16.5 dB (Maximum volume)
Default setting	+16.5 dB
Adjustment increments	5.0 dB

Setting the startup volume

Init.Volume

Sets the initial volume for when this receiver is turned on. When this parameter is set to “Off,” the volume is set at the level when the receiver last entered standby mode. 1

Adjustable range	Off, Mute, -80 dB to +16.5 dB
Default setting	Off
Adjustment increments	0.5 dB

Changing the output destination of HDMI input audio signals

HDMI Audio Out

Choose whether to playback audio from an external component such as a BD/DVD player connected via HDMI through this unit or through a TV.

Amp (Default)	Outputs audio through this unit only. When this setting is selected, the external component outputs an audio format compatible with this unit.
TV	Outputs audio through a TV only. When this setting is selected, the external component outputs an audio format compatible with the TV.  2
Amp+TV	Outputs audio from the TV and this unit. When this setting is selected, the external component outputs an audio format compatible with this unit and TV.

 1: When you set the “Max Volume” at a lower level than “Init.Volume,” the “Max Volume” setting has priority.

 2: When “TV” is selected, the speakers of this unit do not output sound.

Making the receiver easier to use



Func. Setup submenu

Input Rename	Changes the input source names.
AutoPowerDown	Goes into standby mode.
Dimmer	Sets the Brightness of the front panel display.

Changing input source names

Input Rename

Changes the input source names to be shown on the front panel display.

You can change an input source name by choosing from a list of templates, or make one of your own.

■ Selecting a template

- 1 Select "Input Rename" from the Setup menu and press **[9]ENTER**.



- 2 Select the input source that you want to rename using **[9]Cursor** Δ / ∇ .

- 3 Use **[9]Cursor** $\triangleleft / \triangleright$ to select a new name from the following templates.

Blu-ray	Satellite
DVD	VCR
SetTopBox	Tape
Game	MD
TV	PC
DVR	iPod
CD	HD DVD
CD-R	(blank)

- 4 Confirm the new display name by pressing **[9]RETURN**. Press **[8]SETUP** to exit the Setup menu.

To cancel a name change, select the original name and then press **[9]RETURN** to exit renaming.

■ Entering an original name

- 1 Select "Input Rename" from the Setup menu and press **[9]ENTER**.

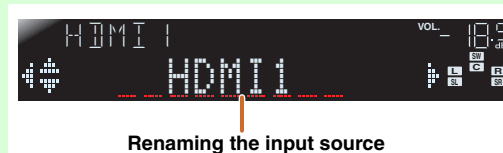

- 2 Select the input source that you want to rename using **[9]Cursor** Δ / ∇ .

- 3 Press **[9]ENTER**.



- 4 Use **[9]Cursor** Δ / ∇ to select the characters you wish to change, and use **[9]Cursor** $\triangleleft / \triangleright$ to enter those characters.

The following characters are available for input source.

- A to Z, a to z
- 0 to 9
- Symbols (#, *, -, +, etc.)
- Space

- 5 Repeat step 4 until you have entered the new input source name.

- 6 Confirm the new display name by pressing **[9]ENTER**. Press **[8]SETUP** to exit the Setup menu.

To cancel a name change, press **[9]RETURN**.

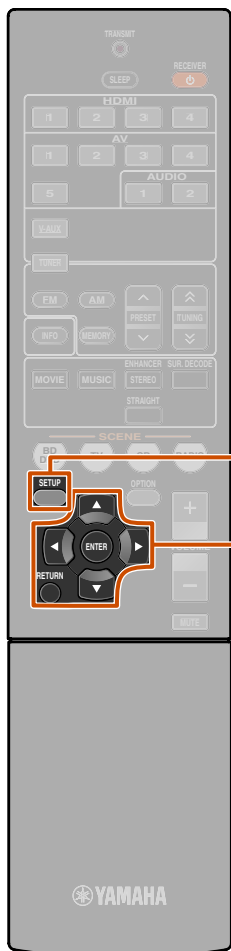

- [8] SETUP**
- [9] Cursor** $\Delta / \nabla / \triangleleft / \triangleright$
- [9] ENTER**
- [9] RETURN**

■ Goes enter standby mode automatically when you leave it without operating

AutoPowerDown

If you do not operate this unit or use the remote control for an extended period of time, it will automatically go into standby mode (Auto Power Down function). This function's default setting is "Off." When you wish to activate this function, set the amount of time to pass before this unit will enter standby.

Off (Default)	Auto Power Down function is disabled.
4hours	Goes into standby mode, when you have not operated this unit for four hours.
8hours	Goes into standby mode, when you have not operated this unit for eight hours.
12hours	Goes into standby mode, when you have not operated this unit for twelve hours.

This unit starts a countdown of 30 seconds before entering the standby mode. Pressing any key of the remote control during the countdown cancels entering the standby mode and reset the timer.

■ Setting the brightness of the front panel display

Dimmer

Sets the brightness of the front panel display. Lowering the setting dims the display.

Adjustable range	-4 to 0
Default setting	0

Setting sound field program parameters

You can set the parameters for the sound field programs (p. 44).



Prohibiting setting changes



Prohibits setting changes to prevent careless changes being made to the settings on Setup menu.

Off (Default)	Settings are not protected.
On	Prohibits changes to the settings on Setup menu until it is returned to "Off." While set to "On," the unit displays "Memory Guard!" when an attempt is made to change the settings.

Setting sound field program parameters

Although the sound field programs would satisfy you as they are with the default parameters, you can arrange the effect by setting the sound field elements (parameters). To adjust the sound effects suitable for acoustical conditions of audio/video sources or rooms, perform the following operations.

Setting sound field parameters

1 Press **[8] SETUP** to display the Setup menu.

2 Use **[9] Cursor** Δ / ∇ to select "DSP Parameter" and press **[9] ENTER**.



3 Use **[9] Cursor** \langle / \rangle to choose the sound field program you want to edit.



Sound field program to be edited

4 Press **[9] Cursor** Δ / ∇ to select the parameter that you want to change, and press **[9] Cursor** \langle / \rangle to change the parameter.



Sound field parameter

Choices

When there are multiple parameters in the sound field program you are configuring, repeat step 4 as necessary to change other parameters.

5 Once you have completed editing, press **[8] SETUP** to close the Setup menu.

■ To initialize the sound field parameters

To set the parameters of the sound field program back to default, press **[9] Cursor** ∇ repeatedly during editing to select "Initialize" and press **[9] Cursor** \triangleright . When "Press Again >" is displayed, press **[9] Cursor** \triangleright again to initialize.



To cancel operations, press **[9] Cursor** \langle when "Press Again" appears and return to the original display.

CINEMA DSP parameters

DSP Level

Change the effect level (level of the sound field effect to be added). You can adjust the level of the sound field effect while checking the sound effect.

Adjustable range	-6 dB to 0 dB to +3 dB
Default setting	0 dB

Adjust "DSP Level" as follows:

- The effect sound is too soft.
→ Increase the effect level.
- There are no differences between effects of the sound field programs.
→ Increase the effect level.
- The sound is dull.
→ Reduce the effect level.
- The sound field effect is added too much.
→ Reduce the effect level.

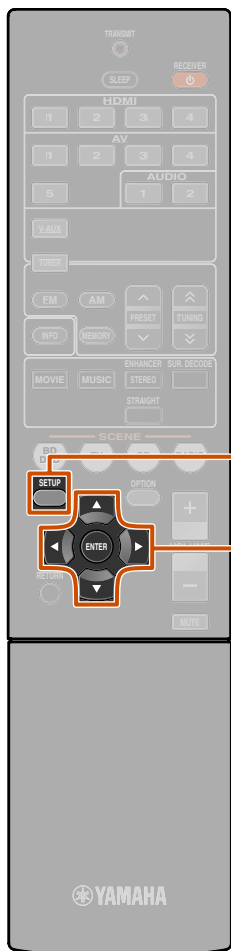

[8] SETUP

[9] Cursor $\Delta / \nabla / \langle / \rangle$

[9] ENTER

Parameters usable in certain sound field programs

2ch Stereo only

Direct

Automatically bypasses the DSP circuit and tone control circuit depending on the condition of tone control etc., when an analog sound source is played back. You can enjoy a higher quality sound.

Auto (Default)	Outputs sound by bypassing the DSP circuit and tone control circuit when both tone controls of “Bass” and “Treble” are set to 0dB.
Off	Does not bypass the DSP circuit and tone control circuit.

5ch Stereo only

CT Level

Adjusts the center channel volume. 🗏1

Adjustable range	0 to 100%
Default setting	100%

SL Level

Adjusts the volume of the surround L channel. 🗏1

Adjustable range	0 to 100%
Default setting	100%

SR Level

Adjusts the volume of the surround R channel. 🗏1

Adjustable range	0 to 100%
Default setting	100%

Straight Enhancer/5ch Enhancer only

EFCT LVL

Adjusts the effect level of the compressed music enhancer mode.

High (Default)	Standard effect.
Low	Sets when the high-frequency signals of the source are emphasized excessively.

Parameters usable in surround decoder

PLII Music only

Panorama

Adjusts the soundscape of the front sound field. Sends front left/right channels sounds to the surround speakers as well as the front speakers for a wraparound effect.

Off (Default)	Disables the effect.
On	Enables the effect.

CT Width

Spreads the center channel sound to the front left and right speakers to suit your needs or preferences. Set this parameter to 0 for outputting the center sound from the center speaker only, or to 7 for outputting it from the front left/right speaker only.

Adjustable range	0 to 7
Default setting	3

Dimension

Adjusts the difference in level between the front sound field and the surround sound field. You can adjust the difference in level created by the software being played back to obtain the preferred sound balance.

The surround sound gets stronger as you make the value more negative, and the front sound gets stronger as you make the value more positive.

Adjustable range	-3 to STD to +3
Default setting	STD (Standard)

🗏1 : Not displayed when speakers are set to be inactive.

Extended functionality that can be configured as needed (Advanced Setup menu)

The Advanced Setup menu can be used for unit initialization and other useful extended functions. The Advanced Setup menu can be operated as follows.

Displaying/Setting the Advanced Setup menu

1 Set this unit to the standby mode.

2 Press **⏻** while pressing and holding **STRAIGHT** on the front panel.

Release the keys when “ADVANCED SETUP” is displayed on the front panel display.

After approximately 3 seconds, the top menu items are displayed.

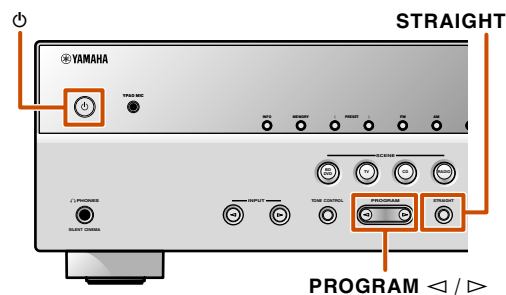

3 Use **PROGRAM** to select the item to be set from the following items.

In the Advanced Setup menu, you can set the following settings.

REMOTE ID	Changes the remote control ID of a receiver.
INIT	Initializes various settings for this unit.

4 Press **STRAIGHT** a few times to select the value you wish to change.

5 Switch this unit to the standby mode, and then switch it on again.

The settings become effective and the unit is powered on. If initialization is selected, it will be performed when the unit is powered on again.

Avoiding crossing remote control signals when using multiple Yamaha receivers



The remote control of the unit can only receive signals from a receiver which has an identical ID (remote control ID). When using multiple Yamaha AV receivers, you can set each remote control with a unique remote control ID for its corresponding receiver.

On the contrary, if you are setting the same remote control ID for all receivers, you can use one remote control to operate 2 receivers.

ID1 (Default)	Receives the remote control signals set in ID1.
ID2	Receives the remote control signals set in ID2.

■ To change the remote control ID

- To set to ID1
Press **9**Cursor **<** and “BD/DVD” under **7**SCENE for 3 seconds or longer.
- To set to ID2
Press **9**Cursor **<** and “TV” under **7**SCENE for 3 seconds or longer.

Initializing various settings for this unit



Initializes various settings stored in this unit and sets it back to default.

Select the items to be initialized from the following.

DSP PARAM	Initializes all parameters for the sound field programs.
ALL	Resets this unit to default factory settings.
CANCEL (Default)	Does not initialize.

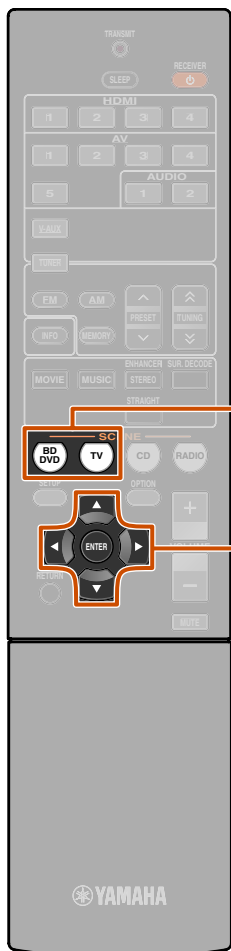

7 SCENE
9 Cursor **<**

APPENDIX

Troubleshooting

Refer to the table below when this unit does not function properly.

If the problem you are experiencing is not listed below, or if the instructions below do not help, turn off this unit, disconnect the power cable, and contact the nearest authorized Yamaha dealer or service center.

General

Problem	Cause	Remedy	See page
The power will not turn on.	The protection circuitry operated three times consecutively.	As a safety precaution, when the protection circuitry operates three times consecutively, the capability to turn on the power is disabled. Please contact your nearest Yamaha dealer or service center to request repair.	—
The unit enters standby mode soon after the power is turned on.	The power cable is not completely inserted.	Connect the power cable properly to an AC wall outlet.	—
	(When this unit is turned back on and “CHECK SP WIRES!” is displayed.) The protection circuitry has been activated because this unit was turned on while a speaker cable was shorted.	Make sure that all speaker cables between this unit and speakers are connected properly.	11
This unit cannot be turned off or does not work properly.	The internal microcomputer is hung-up due to an external electric shock (such as lightning or excessive static electricity) or by a drop in power supply voltage.	Disconnect the power cable from the AC wall outlet, wait about 30 seconds and then plug it in again.	—
	The batteries in the remote control may have lost their charge.	Replace all batteries.	4
The unit enters standby mode.	The protection circuitry has been activated because of a short circuit, etc.	Check that the speaker with an impedance of at least 6Ω.	—
After display of a countdown on the front panel, the unit goes into standby mode.	If you do not use take any action, the Auto Power Down function operates.	Turn on the unit, and play the source again.	—
		In the Setup menu “AutoPowerDown” (“Func. Setup” → “AutoPowerDown”), increase the time until switching to standby mode, or turn off the Auto Power Down function.	43

Problem	Cause	Remedy	See page
“Internal Error” is displayed on the front panel display.	An internal error has occurred.	Please contact authorized Yamaha dealer or service center to request repair.	—
Sound/images suddenly go off.	The protection circuitry has been activated because of a short circuit, etc.	Check that the speaker wires are not touching each other, then turn the unit back on.	—
	The sleep timer has turned off the unit.	Turn on the unit, and play the source again.	—



Problem	Cause	Remedy	See page
No sound.	Incorrect input or output cable connections.	Connect the cables properly. If the problem persists, the cables may be defective.	15
	If a DVI-HDMI cable is used to connect the unit with an external component, then it is necessary to use an audio input jack for a different input to output audio.	Display the HDMI Input Option menu for the connected cable, select "Audio In," and select the jack to use for audio input.	35
	Speaker connections are not secure.	Secure the connections.	11
	The HDMI components connected to the unit do not support the HDCP copy protection standards.	Connect HDMI components that support the HDCP copy protection standards.	35
	The audio input into the device is set to playback through the TV.	In the Setup menu, set the HDMI Audio Out ("Sound Setup" → "HDMI Audio Out") to other than "TV."	41
	No appropriate input source has been selected.	Select an appropriate input source with [3]Input selector (on the remote control).	25
	The volume is turned down or muted.	Turn up the volume.	—
	Signals that this unit cannot reproduce are being input from a source component, such as a CD-ROM.	Use an input source that has signals that can be reproduced on this unit.	—
No picture.	A video jack (ex. Video input → HDMI output) type different to the input video is being used to try to display content on the TV.	Use video jacks of the same type (ex. Video input → Video output) to connect to the TV.	13
	An appropriate video input is not selected on the TV.	Select an appropriate video input on the TV.	—

Problem	Cause	Remedy	See page
No sound is output from a specific speaker.	The speaker is malfunctioning. Check the Speaker indicators on the front panel display. If the corresponding indicator lights up, connect another speaker and check if sound is output.	If sound is not output, the unit may be malfunctioning.	7
	The playback component or speakers are not connected properly.	Connect the cables properly. If the problem persists, the cables may be defective.	11, 15
	Output from that speaker is disabled.	Check the Speaker indicators on the front panel display. If the corresponding indicator is turned off, try the following. 1) Change to a different input source. 2) With the selected sound field program, sound is not output from that speaker. Select another sound field program. 3) "None" may have been selected for that speaker on this unit. Display "Speaker Setup" in the Setup menu, and set respective parameters to enable output from that speaker ("Speaker Setup" → "Config").	7, 37
	The volume of that speaker is set to the minimum in "Speaker Setup" in the Setup menu.	Display "Speaker Setup" in the Setup menu and adjust the volume ("Speaker Setup" → "Level").	38
	(If hardly any sound comes from one channel) Speaker output balance is not set correctly.	Balance the volume of each speaker from "Level" in the Setup menu ("Speaker Setup" → "Level").	38
	Sound may not be output from certain channels, depending on the input source or sound field program.	Try another sound field program.	26
	Only the center speaker outputs substantial sound.	When a monaural source sound field program is applied, for some surround decoders, sound from all channels is output from the center speaker.	Try another sound field program.



Problem	Cause	Remedy	See page
No sound is heard from the surround speakers.	This unit is in straight decoding mode and a monaural source is being played back.	Press 6 STRAIGHT (on the remote control) to exit straight decoding mode.	27
	Sound may not be output from certain channels depending on input sources or sound field programs.	Try another sound field program.	26
No sound is heard from the subwoofer.	A subwoofer is not connected, or it is disabled.	Check that a subwoofer is connected correctly, and from the Setup menu "Subwoofer" ("Speaker Setup" → "Config" → "Subwoofer"), set the subwoofer to "On."	37
	The subwoofer is turned off.	Turn the subwoofer power on. If the subwoofer includes an Auto Power Off function, then lower the Auto Power Off sensitivity settings.	—
	The source does not contain LFE (p. 52) or low frequency signals.		—
The right combination of audio / video jacks to connect cannot be found.	Combine input connected to the external component video output with another input audio jack.	Select a desired input source (HDMI1-4 or AV1-2) as a video input and select an audio input source from "Audio In" in the Option menu.	35
The audio input sources cannot be played in the desired digital audio signal format.	The connected component is not set to output the desired digital audio signals.	Set the playback component properly referring to its instruction manual.	—
	This unit does not support playback of HD Audio (TrueHD, Dolby Digital plus, DTS Master Audio, etc.) or DTS 96/24, etc.	Signals, such as HD Audio and DTS 96/24, can be played by standard decoders (Dolby Digital, DTS Digital Surround, etc.).	—
There is noise interference from digital or radio frequency equipment.	This unit is too close to other digital or radio frequency equipment.	Move this unit further away from such equipment.	—

Problem	Cause	Remedy	See page
Noise/hum noise is heard.	Incorrect cable connection. Connect the audio cables properly.	If the problem persists, the cables may be defective.	—
	A DTS-CD is being played back.	If a DTS bitstream signal is not properly input to this unit, only noise is output. Connect the playback component to this unit by digital connection and play back the DTS-CD. If the condition is not resolved, the problem may result from the playback component. Consult the manufacturer of the playback component.	—
The volume cannot be increased, or the sound is distorted.	The component connected to the output jacks of this unit is not turned on.	When the component connected to the output jacks of this unit is not turned on, the sound may be distorted, or the volume may decreased due to the nature of AV receivers. Turn on all components connected to this unit.	—
	"Max Volume" is set to a low value.	Set it to a higher value.	41



HDMI™

Problem	Cause	Remedy	See page
The front panel display HDMI indicator is flashing.	An error with the HDMI connection has occurred.	Try re-inserting the HDMI cable.	—
		Confirm that HDMI video that is not supported by the unit is not being input (HDMI Input → Option menu → "Signal Info").	35
No picture or sound.	The number of components is over the limit.	Disconnect some of the HDMI components.	—
	The connected HDMI component does not support high-bandwidth digital copyright protection (HDCP).	Connect an HDMI component that supports HDCP.	—



Tuner (FM/AM)

FM

Problem	Cause	Remedy	See page
FM stereo reception is noisy.	You are too far from the station transmitter, or the input from the antenna is weak.	Check the antenna connections.	20
		Switch to monaural mode.	30
		Replace the outdoor antenna with a more sensitive multi-element antenna.	—
There is distortion, and clear reception cannot be obtained even with a good FM antenna.	There is multi-path interference.	Adjust the antenna height or orientation, or place it in a different location.	—
The desired station cannot be tuned into with the automatic tuning method.	You are in an area far from a station, or input from the antenna is weak.	Replace the outdoor antenna with a more sensitive multi element antenna.	—
		Use  TUNING  /  (on the remote control) to manually select the station.	30
“No Presets” is displayed.	No preset stations are registered.	Register stations you wish to listen to as preset stations before operation.	31

AM

Problem	Cause	Remedy	See page
The desired station cannot be tuned into with the automatic tuning method.	The signal is weak, or the antenna connections are loose.	Adjust the AM loop antenna orientation.	20
		Use the manual tuning method.	30
Automatic station preset does not work.	Automatic station preset is not available for AM stations.	Use manual station preset.	31
Continuous crackling and hissing noises are heard.	The supplied AM loop antenna is not connected.	Connect the AM loop antenna correctly even if you use an outdoor antenna.	20
	The noises may be caused by lightning, fluorescent lamps, motors, thermostats, or other electrical equipment.	It is difficult to completely eliminate noise, but it can be reduced by installing and properly grounding an outdoor AM antenna.	20
Buzzing and whining noises are heard.	A TV set is being used nearby.	Move this unit away from the TV set.	—



Remote control

Problem	Cause	Remedy	See page
The remote control does not work or function properly.	Wrong distance or angle.	The remote control will function within a maximum range of 6 m / 20 ft, and no more than 30 degrees off-axis from the front panel.	—
	Direct sunlight or lighting (from an inverter type of fluorescent lamp, strobe light, etc.) is striking the remote control sensor of this unit.	Adjust the lighting angle, or reposition this unit.	—
	The batteries are weak.	Replace all batteries.	4
	The remote control ID of the remote control and this unit do not match.	Match the remote control ID of this unit and the remote control.	46
External components cannot be controlled using the remote control.	The remote control code is not correctly set.	If this unit does not work when you press [9]Cursor $\Delta / \nabla / \triangleleft / \triangleright$ (on the remote control), do the following. When the key does not work during DVD disc menu operation: press the [3]Input selector (on the remote control) again.	—
		When the key does not work during Option menu/Setup menu operation: press the key corresponding to the current menu operation again.	—
		Even if the remote control code is correctly set, there are some models that do not respond to the remote control.	—



Glossary

Audio information

Audio and video synchronization (lip sync)

Lip sync, an abbreviation for lip synchronization, is a technical term that involves both a problem, and the capability of maintaining audio and video signals synchronized during post-production and transmission.

Whereas the audio and video latency requires complex end-user adjustment, HDMI version 1.3 incorporates an automatic audio and video syncing capability that allows devices to perform this synchronization automatically and accurately without user interaction.

Dolby Digital

Dolby Digital is a digital surround sound system that gives you completely independent multi-channel audio. With 3 front channels (front L/R and center), and 2 surround stereo channels, Dolby Digital provides 5 full-range audio channels. With an additional channel especially for bass effects, referred to as LFE (Low-Frequency Effect), the system has a total of 5.1-channels (LFE is counted as 0.1 channel). By using 2-channel stereo for the surround speakers, more accurate moving sound effects and surround sound environments are possible than with Dolby Surround. The wide dynamic range from maximum to minimum volumes that are reproduced by the 5 full-range channels, and the precise sound orientation generated using digital sound processing provides listeners with unprecedented excitement and realism. With this unit, any sound environment from monaural up to a 5.1-channel configuration can be freely selected for your enjoyment.

Dolby Pro Logic II

Dolby Pro Logic II is an improved technique used to decode vast numbers of existing Dolby Surround sources. This new technology enables a discrete 5-channel playback with 2 front left and right channels, 1 center channel, and 2 surround left and right channels, instead of only 1 surround channel for conventional Pro Logic technology. There are three modes available: “Music mode” for music sources, “Movie mode” for movie sources, and “Game mode” for game sources.

Dolby Surround

Dolby Surround uses a 4-channel analog recording system to reproduce realistic and dynamic sound effects: 2 front left and right channels (stereo), a center channel for dialog (monaural), and a surround channel for special sound effects (monaural). The surround channel reproduces sound within a narrow frequency range. Dolby Surround is widely used with nearly all video tapes and laser discs, as well as in many TV and cable broadcasts. The Dolby Pro Logic decoder built into this unit employs a digital signal processing system that automatically stabilizes the volume on each channel to enhance moving sound effects and directionality.

DTS Digital Surround

DTS Digital Surround was developed to replace the analog soundtracks of movies with a 5.1-channel digital sound track, and is now rapidly gaining popularity in movie theaters around the world. DTS, Inc. has developed a home theater system so that you can enjoy the depth of sound and natural spatial representation of DTS Digital Surround in your home. This system produces practically distortion-free 5.1-channel sound (technically, left, right and center channels, 2 surround channels, plus an LFE 0.1 channel as a subwoofer, for a total of 5.1-channels).

DSD

Direct Stream Digital (DSD) technology stores audio signals on digital storage media, such as Super Audio CDs. Using DSD, signals are stored as single bit values at a high-frequency sampling rate of 2.8224 MHz, while noise shaping and oversampling are used to reduce distortion, a common occurrence with very high quantization of audio signals. Due to the high sampling rate, better audio quality can be achieved than that offered by the PCM format used for normal audio CDs. The frequency is equal to or higher than 100 kHz, with a dynamic range of 120 dB. This unit can transmit or receive DSD signals via the HDMI jack.

LFE 0.1 channel

This channel reproduces low-frequency bass signals, and has a frequency range from 20 Hz to 120 Hz. This channel is counted as 0.1, because it only enforces a low-frequency range compared to the full-range reproduced by the other 5 channels in Dolby Digital or DTS 5.1-channel systems.

PCM (Linear PCM)

Linear PCM is a signal format under which an analog audio signal is digitized, recorded and transmitted without using any compression. This is used as a method of recording CDs and DVD audio. The PCM system uses a technique for sampling the size of the analog signal per very small unit of time. Standing for “Pulse Code Modulation,” the analog signal is encoded as pulses and then modulated for recording.

Sampling frequency and number of quantized bits

When digitizing an analog audio signal, the number of times the signal is sampled per second is called the sampling frequency, while the degree of accuracy when converting the sound level into a numeric value is called the number of quantized bits. The range of rates that can be played back is determined based on the sampling rate, whereas the dynamic range representing the sound level difference is determined by the number of quantized bits. In principle, the higher the sampling frequency, the wider the range of frequencies that can be played back, and the higher the number of quantized bits, the more accurately the sound level can be reproduced.

Sound field program information

CINEMA DSP

Since the Dolby Surround and DTS systems were originally designed for use in movie theaters, their effect is best felt in a theater having many speakers designed for acoustic effects. Since home conditions, such as room size, wall material, number of speakers, and so on, can differ so widely, it is inevitable that there are differences in the sound that is heard. Based on a wealth of actually measured data, Yamaha CINEMA DSP uses Yamaha’s original DSP technology to combine Dolby Pro Logic, Dolby Digital, and DTS systems to provide the audiovisual experience of a movie theater in the listening room of your own home.

Compressed music enhancer

The Compressed music enhancer feature of this unit enhances your listening experience by regenerating the missing harmonics in compression artifacts. As a result, it compensates for flattened complexity due to the loss of high-frequency fidelity as well as lack of bass due to the loss of low-frequency bass, providing improved performance for the overall sound system.



SILENT CINEMA

Yamaha has developed a natural, realistic sound effect DSP algorithm for headphones. Parameters for headphones have been set for each sound field program, so that accurate representations of all the sound field programs can be enjoyed on headphones.

Virtual CINEMA DSP

Yamaha has developed a Virtual CINEMA DSP algorithm that allows you to enjoy DSP surround effects even without any surround speakers, by using virtual surround speakers. It is even possible to enjoy Virtual CINEMA DSP using a minimal two-speaker system that does not include a center speaker.

Video information**Component video signal**

With the component video signal system, the video signal is separated into the Y signal for luminance and the PB and PR signals for chrominance. Color can be reproduced more faithfully with this system because each of these signals is independent. The component signal is also called the “color difference signal” because the luminance signal is subtracted from the color signal. A monitor with component input jacks is required in order to output component signals.

Composite video signal

With the composite video signal system, the video signal comprises the three basic elements of a video picture: color, brightness and synchronization data. A composite video jack on a video component transmits these three elements combined.

Deep Color

Deep Color refers to the use of various color depths in displays, up from the 24-bit depths in previous versions of the HDMI specification. This extra bit depth allows HDTVs and other displays increase from millions of colors to billions of colors and eliminate on-screen color banding for smooth tonal transitions and subtle gradations between colors. The increased contrast ratio can represent many times more shades of gray between black and white. Additionally, Deep Color increases the number of available colors within the boundaries defined by the RGB or YCbCr color space.

HDMI

HDMI (High-Definition Multimedia Interface) is the first industry supported, uncompressed, all-digital audio/video interface. Providing an interface between any sources (such as set-top boxes or AV receivers) and audio/video monitors (such as digital TV), HDMI supports standard, enhanced or high-definition video as well as multichannel digital audio using a single cable. HDMI transmits all ATSC HDTV standards and supports 8-channel digital audio, with bandwidth to spare to accommodate future enhancements and requirements.

When used in combination with HDCP (High-bandwidth Digital Content Protection), HDMI provides a secure audio/video interface that meets the security requirements of content providers and system operators. For further information on HDMI, visit the HDMI website at “<http://www.hdmi.org/>.”

“x.v.Color”

A color space standard supported by HDMI version 1.3. It is a more extensive color space than sRGB, and allows the expression of colors that were not hitherto possible. While remaining compatible with the color gamut of sRGB standards, “x.v.Color” expands the color space, and can thus produce more vivid, natural images. It is particularly effective for still pictures and computer graphics.



Information on HDMI™

■ HDMI signal compatibility

Audio signals

Audio signal types	Audio signal formats	Compatible media
2ch Linear PCM	2ch, 32-192 kHz, 16/20/24 bit	CD, DVD-Video, DVD-Audio, etc.
Multi-ch Linear PCM	8ch, 32-192 kHz, 16/20/24 bit	DVD-Audio, Blu-ray Disc, HD DVD, etc.
DSD	2/5.1ch, 2.8224 MHz, 1 bit	SACD, etc.
Bitstream	Dolby Digital, DTS	DVD-Video, etc.

- If the input source component can decode the bitstream audio signals of audio commentaries, you can play back the audio sources with the audio commentaries mixed down by using the digital audio input (optical or coaxial) connections.
- Refer to the supplied instruction manuals of the input source component, and set the component appropriately.

NOTES

- When CPPM copy-protected DVD-Audio is played back, video and audio signals may not be output, depending on the type of the DVD player.
- This unit is not compatible with HDCP-incompatible HDMI or DVI components.
- Refer to the supplied instruction manuals for details.
To decode audio bitstream signals on this unit, set the input source component appropriately so that the component outputs the bitstream audio signals directly (does not decode the bitstream signals on the component).
- This unit is not compatible with the audio commentary features (for example, the special audio contents downloaded via Internet) of Blu-ray Disc or HD DVD. This unit does not play back the audio commentaries of the Blu-ray Disc or HD DVD content.

Video signals

This unit is compatible with the video signals of the following resolutions:

- 480i/60 Hz
- 576i/50 Hz
- 480p/60 Hz
- 576p/50 Hz
- 720p/60 Hz, 50 Hz
- 1080i/60 Hz, 50 Hz
- 1080p/60 Hz, 50 Hz, 24 Hz

About trademarks



Manufactured under license from Dolby Laboratories.

“Dolby,” “Pro Logic,” and the double-D symbol are trademarks of Dolby Laboratories.



Manufactured under license under U.S. Patent #'s: 5,451,942; 5,956,674; 5,974,380; 5,978,762; 6,487,535 & other U.S. and worldwide patents issued & pending. DTS and DTS Digital Surround are registered trademarks and the DTS logos and Symbol are trademarks of DTS, Inc. ©1996-2008 DTS, Inc. All Rights Reserved.

HDMI

“HDMI,” the “HDMI” logo and “High-Definition Multimedia Interface” are trademarks, or registered trademarks of HDMI Licensing LLC.

SILENT™
CINEMA

“SILENT CINEMA” is a trademark of Yamaha Corporation.



Specifications

■ HDMI specification

- Deep Color
- x.v.Color
- Auto Lip sync

■ INPUT/OUTPUT

Input jacks

- HDMI input x 4
- AV input x 5
 - [Audio] Digital input (optical) x 2, digital input (coaxial) x 2, analog input x 1
 - [Video] Component video jacks x 2, video jacks x 3
- AUDIO input x 2
 - [Audio] Analog jack x 2
- VIDEO AUX input x 1
 - [Audio] Analog x 1, stereo mini jack x 1
 - [Video] Video jack x 1

Output jacks

- TV output (monitor output) x 3
 - [Audio/Video] HDMI x 1
 - [Video] Component video jack x 1, video jack x 1
- AV output x 2
 - [Audio] Analog jack x 1
 - [Video] Video jack x 1
- AUDIO output x 1
 - [Audio] Analog jack x 1

■ AUDIO SECTION

- Surround Decoder
 - Dolby Digital, Dolby Pro Logic, Dolby Pro Logic II
 - DTS Digital Surround
 - DSD

- Minimum RMS Output Power for Front, Center, Surround
 - [U.S.A. and Canada models]
 - (1 kHz, 0.9% THD, 8 Ω)
 - FRONT L/R.....100 W/ch
 - CENTER100 W
 - SURROUND L/R.....100 W/ch
 - [Other models]
 - (1 kHz, 0.9% THD, 6 Ω)
 - FRONT L/R.....100 W/ch
 - CENTER100 W
 - SURROUND L/R.....100 W/ch
- Dynamic Power (IHF)
 - [U.S.A. and Canada models]
 - Front Speakers 8/6/4/2 Ω 110/130/160/180 W
 - [Other models]
 - Front Speakers 6/4/2 Ω 105/130/150 W
- Maximum Useful Output Power (JEITA)
 - [China, Korea, General and Asia models]
 - 1 kHz, 10% THD, 6 Ω 135 W
- Maximum Output Power [U.K., Europe and Asia models]
 - 1 kHz, 0.7% THD, 4 Ω 120 W
- IEC Output Power [U.K., Europe and Asia models]
 - Front Speakers 1 kHz, 0.9% THD, 8 Ω 95 W+95 W
- Dynamic Headroom [U.S.A. and Canada models]
 - 8 Ω0.23 dB
- Input Sensitivity/Input Impedance
 - AV5, etc 200 mV/47 k Ω
- Maximum Input Voltage
 - AV5, etc. (1 kHz, 0.5% THD) 2.3 V or more
- Rated Output Voltage/Output Impedance
 - AUDIO OUT 200 mV/1.2 k Ω
 - SUBWOOFER (2ch Stereo & Front: Small) 1.0 V/1.2 k Ω
- Headphone Jack Rated Output/Impedance
 - AV5, etc. (1 kHz, 50 mV, 8 Ω) 100 mV/470 Ω

- Frequency Response
 - AV5 to FRONT 10 Hz to 100 kHz, +0/-3 dB
- Total Harmonic Distortion
 - AV5, etc. to FRONT
 - [U.S.A. and Canada models] (1 kHz, 50 W, 8 Ω)..... 0.06% or less
 - [Other models] (1 kHz, 50 W, 6 Ω) 0.06% or less
- Signal to Noise Ratio (IHF-A Network)
 - AV5, etc. Input Shorted (250 mV to Front Speakers)
 - 98 dB or more
- Residual Noise (IHF-A Network)
 - Front Speakers 150 μ V or less
- Channel Separation (1 kHz/10 kHz)
 - AV5, etc. (5.1 k Ω shortened)60 dB/45 dB or more
- Volume Control MUTE / -80 dB to +16.5 dB
- Tone Control (Front Speakers)
 - BASS Boost/Cut \pm 10 dB/2 dB at 50 Hz
 - BASS Turnover Frequency 350 Hz
 - TREBLE Boost/Cut \pm 10 dB/2 dB at 20 kHz
 - TREBLE Turnover Frequency 3.5 kHz
- Filter Characteristics (fc=40/60/80/90/100/110/120/160/200 Hz)
 - H.P.F. (Front, Center, Surround) 12 dB/oct.
 - L.P.F. (Subwoofer) 24 dB/oct.

■ VIDEO SECTION

- Video Signal Type
 - [U.S.A., Canada, Korea and General models] NTSC
 - [Other models]PAL
- Signal Level
 - Composite 1 Vp-p/75 Ω
 - Component 1 Vp-p/75 Ω (Y), 0.7 Vp-p/75 Ω (Pb/Pr)
- Maximum Input Level (Video Conversion Off) 1.5 Vp-p or more
- Signal to Noise Ratio 50 dB or more
- Frequency Response [MONITOR OUT]
 - Component (Video Conversion Off) 5 Hz to 60 MHz, \pm 3 dB



■ FM SECTION

- Tuning Range
 - [U.S.A. and Canada models]87.5 to 107.9 MHz
 - [Asia and General models] 87.5/87.50 to 108.0/108.00 MHz
 - [Other models]87.50 to 108.00 MHz
- 50 dB Quieting Sensitivity (IHF)
 - Mono 3.0 μV (20.8 dBf)
- Signal to Noise Ratio (IHF)
 - Mono/Stereo 74 dB/69 dB
- Harmonic Distortion (1 kHz)
 - Mono/Stereo 0.3/0.3%
- Antenna Input (unbalanced) 75 Ω

■ AM SECTION

- Tuning Range
 - [U.S.A. and Canada models]530 to 1710 kHz
 - [Asia and General models] 530/531 to 1710/1611 kHz
 - [Other models]531 to 1611 kHz

■ GENERAL

- Power Supply
 - [U.S.A. and Canada models] AC 120 V, 60 Hz
 - [General models] AC 110-120/220-240 V, 50/60 Hz
 - [China model] AC 220 V, 50 Hz
 - [Korea model] AC 220 V, 60 Hz
 - [Australia model] AC 240 V, 50 Hz
 - [U.K. and Europe models] AC 230 V, 50 Hz
 - [Asia models] AC 220-240 V, 50/60 Hz

- Power Consumption
 - [U.S.A. and Canada models]250 W/320 VA
 - [Other models] 250 W
- Standby Power Consumption
 - [General models]1.0 W or less
 - [Other models]0.5 W or less
- Dimensions (W x H x D)
 - 435 x 151 x 315 mm (17-1/8 x 6 x 12-3/8 in)
- Weight
 - 7.5 kg (16.5 lbs)

* Specifications are subject to change without notice.

Index

A		O	
Advanced Setup menu	46	Option menu	34
AM tuning	30	R	
Antenna connection	20	Rear panel.....	6
C		Remote control, Part names and functions.....	8
Cable plug	12	S	
Connections.....	9	SCENE function.....	26
E		Setup menu.....	36
External device connection	12	Sound field program.....	26
F		Sound field program parameter setting	44
FM tuning.....	30	Speaker connection	9
Front panel	5	Speaker setting	21
Front panel display.....	7	Supplied accessories.....	4
J			
Jack	12		



