



# DIGITAL KEYBOARD

# PSR-E443



## Owner's Manual



EN

Setting Up

Quick Guide

Reference

Appendix

## SPECIAL MESSAGE SECTION

This product utilizes batteries or an external power supply (adapter). DO NOT connect this product to any power supply or adapter other than one described in the manual, on the name plate, or specifically recommended by Yamaha.

**WARNING:** Do not place this product in a position where anyone could walk on, trip over, or roll anything over power or connecting cords of any kind. The use of an extension cord is not recommended! If you must use an extension cord, the minimum wire size for a 25' cord (or less) is 18 AWG. NOTE: The smaller the AWG number, the larger the current handling capacity. For longer extension cords, consult a local electrician.

This product should be used only with the components supplied or; a cart, rack, or stand that is recommended by Yamaha. If a cart, etc., is used, please observe all safety markings and instructions that accompany the accessory product.

### SPECIFICATIONS SUBJECT TO CHANGE:

The information contained in this manual is believed to be correct at the time of printing. However, Yamaha reserves the right to change or modify any of the specifications without notice or obligation to update existing units.

This product, either alone or in combination with an amplifier and headphones or speaker/s, may be capable of producing sound levels that could cause permanent hearing loss. DO NOT operate for long periods of time at a high volume level or at a level that is uncomfortable. If you experience any hearing loss or ringing in the ears, you should consult an audiologist.

**IMPORTANT:** The louder the sound, the shorter the time period before damage occurs.

Some Yamaha products may have benches and / or accessory mounting fixtures that are either supplied with the product or as optional accessories. Some of these items are designed to be dealer assembled or installed. Please make sure that benches are stable and any optional fixtures (where applicable) are well secured BEFORE using.

Benches supplied by Yamaha are designed for seating only. No other uses are recommended.

### NOTICE:

Service charges incurred due to a lack of knowledge relating to how a function or effect works (when the unit is operating as designed) are not covered by the manufacturer's warranty, and are therefore the owners responsibility. Please study this manual carefully and consult your dealer before requesting service.

### ENVIRONMENTAL ISSUES:

Yamaha strives to produce products that are both user safe and environmentally friendly. We sincerely believe that our products and the production methods used to produce them, meet these goals. In keeping with both the letter and the spirit of the law, we want you to be aware of the following:

### Battery Notice:

This product MAY contain a small non-rechargeable battery which (if applicable) is soldered in place. The average life span of this type of battery is approximately five years. When replacement becomes necessary, contact a qualified service representative to perform the replacement.

This product may also use "household" type batteries. Some of these may be rechargeable. Make sure that the battery being charged is a rechargeable type and that the charger is intended for the battery being charged.

When installing batteries, never mix old batteries with new ones, and never mix different types of batteries. Batteries MUST be installed correctly. Mismatches or incorrect installation may result in overheating and battery case rupture.

### Warning:

Do not attempt to disassemble, or incinerate any battery. Keep all batteries away from children. Dispose of used batteries promptly and as regulated by the laws in your area. Note: Check with any retailer of household type batteries in your area for battery disposal information.

### Disposal Notice:

Should this product become damaged beyond repair, or for some reason its useful life is considered to be at an end, please observe all local, state, and federal regulations that relate to the disposal of products that contain lead, batteries, plastics, etc. If your dealer is unable to assist you, please contact Yamaha directly.

### NAME PLATE LOCATION:

The name plate is located on the bottom of the product. The model number, serial number, power requirements, etc., are located on this plate. You should record the model number, serial number, and the date of purchase in the spaces provided below and retain this manual as a permanent record of your purchase.

Model

---

Serial No.

---

Purchase Date

---

## PLEASE KEEP THIS MANUAL

92-BP (bottom)

## FCC INFORMATION (U.S.A.)

### 1. IMPORTANT NOTICE: DO NOT MODIFY THIS UNIT!

This product, when installed as indicated in the instructions contained in this manual, meets FCC requirements. Modifications not expressly approved by Yamaha may void your authority, granted by the FCC, to use the product.

**2. IMPORTANT:** When connecting this product to accessories and/or another product use only high quality shielded cables. Cable/s supplied with this product MUST be used. Follow all installation instructions. Failure to follow instructions could void your FCC authorization to use this product in the USA.

**3. NOTE:** This product has been tested and found to comply with the requirements listed in FCC Regulations, Part 15 for Class "B" digital devices. Compliance with these requirements provides a reasonable level of assurance that your use of this product in a residential environment will not result in harmful interference with other electronic devices. This equipment generates/uses radio frequencies and, if not installed and used according to the instructions found in the users manual, may cause interference harmful to the operation of other electronic devices. Compliance with FCC regulations does

not guarantee that interference will not occur in all installations. If this product is found to be the source of interference, which can be determined by turning the unit "OFF" and "ON", please try to eliminate the problem by using one of the following measures:

Relocate either this product or the device that is being affected by the interference.

Utilize power outlets that are on different branch (circuit breaker or fuse) circuits or install AC line filter/s.

In the case of radio or TV interference, relocate/reorient the antenna. If the antenna lead-in is 300 ohm ribbon lead, change the lead-in to co-axial type cable.

If these corrective measures do not produce satisfactory results, please contact the local retailer authorized to distribute this type of product. If you can not locate the appropriate retailer, please contact Yamaha Corporation of America, Electronic Service Division, 6600 Orangethorpe Ave, Buena Park, CA90620

The above statements apply ONLY to those products distributed by Yamaha Corporation of America or its subsidiaries.

## OBSERVERA!

Apparaten kopplas inte ur växelströmskällan (nätet) så länge som den är ansluten till vägguttaget, även om själva apparaten har stängts av.

**ADVARSEL:** Netspændingen til dette apparat er IKKE afbrudt, så længe netledningen sidder i en stikkontakt, som er tændt — også selvom der er slukket på apparatets afbryder.

**VAROITUS:** Laitteen toisiopiiriin kytketty käyttökytkin ei irroita koko laitetta verkosta.

(standby)

The model number, serial number, power requirements, etc., may be found on or near the name plate, which is at the bottom of the unit. You should note this serial number in the space provided below and retain this manual as a permanent record of your purchase to aid identification in the event of theft.

**Model No.**

---

**Serial No.**

---

(bottom\_en\_01)

## Entsorgung leerer Batterien (nur innerhalb Deutschlands)

Leisten Sie einen Beitrag zum Umweltschutz. Verbrauchte Batterien oder Akkumulatoren dürfen nicht in den Hausmüll. Sie können bei einer Sammelstelle für Altbatterien bzw. Sondermüll abgegeben werden. Informieren Sie sich bei Ihrer Kommune.

(battery)

## COMPLIANCE INFORMATION STATEMENT (DECLARATION OF CONFORMITY PROCEDURE)

Responsible Party : Yamaha Corporation of America  
Address : 6600 Orangethorpe Ave., Buena Park, Calif.  
90620  
Telephone : 714-522-9011  
Type of Equipment : Digital Keyboard  
Model Name : PSR-E443

This device complies with Part 15 of the FCC Rules.

Operation is subject to the following two conditions:

- 1) this device may not cause harmful interference, and
- 2) this device must accept any interference received including interference that may cause undesired operation.

See user manual instructions if interference to radio reception is suspected.

\* This applies only to products distributed by  
YAMAHA CORPORATION OF AMERICA.

(FCC DoC)

## For PSR-E443

### Information for Users on Collection and Disposal of Old Equipment and used Batteries



These symbols on the products, packaging, and/or accompanying documents mean that used electrical and electronic products and batteries should not be mixed with general household waste.

For proper treatment, recovery and recycling of old products and used batteries, please take them to applicable collection points, in accordance with your national legislation and the Directives 2002/96/EC and 2006/66/EC.



By disposing of these products and batteries correctly, you will help to save valuable resources and prevent any potential negative effects on human health and the environment which could otherwise arise from inappropriate waste handling.



For more information about collection and recycling of old products and batteries, please contact your local municipality, your waste disposal service or the point of sale where you purchased the items.

#### [For business users in the European Union]

If you wish to discard electrical and electronic equipment, please contact your dealer or supplier for further information.

#### [Information on Disposal in other Countries outside the European Union]

These symbols are only valid in the European Union. If you wish to discard these items, please contact your local authorities or dealer and ask for the correct method of disposal.



#### Note for the battery symbol (bottom two symbol examples):

This symbol might be used in combination with a chemical symbol. In this case it complies with the requirement set by the Directive for the chemical involved.

Cd

(weee\_battery\_eu\_en\_01)

## For AC Power Adaptor

### Information for Users on Collection and Disposal of Old Equipment



This symbol on the products, packaging, and/or accompanying documents means that used electrical and electronic products should not be mixed with general household waste.

For proper treatment, recovery and recycling of old products, please take them to applicable collection points, in accordance with your national legislation and the Directives 2002/96/EC.



By disposing of these products correctly, you will help to save valuable resources and prevent any potential negative effects on human health and the environment which could otherwise arise from inappropriate waste handling.

For more information about collection and recycling of old products, please contact your local municipality, your waste disposal service or the point of sale where you purchased the items.

#### [For business users in the European Union]

If you wish to discard electrical and electronic equipment, please contact your dealer or supplier for further information.

#### [Information on Disposal in other Countries outside the European Union]

This symbol is only valid in the European Union. If you wish to discard these items, please contact your local authorities or dealer and ask for the correct method of disposal.

(weee\_eu\_en\_01)

# PRECAUTIONS

## PLEASE READ CAREFULLY BEFORE PROCEEDING

Please keep this manual in a safe and handy place for future reference.



### WARNING

Always follow the basic precautions listed below to avoid the possibility of serious injury or even death from electrical shock, short-circuiting, damages, fire or other hazards. These precautions include, but are not limited to, the following:

#### Power supply/AC power adaptor

- Do not place the power cord near heat sources such as heaters or radiators. Also, do not excessively bend or otherwise damage the cord, or place heavy objects on it.
- Only use the voltage specified as correct for the instrument. The required voltage is printed on the name plate of the instrument.
- Use the specified adaptor (page 65) only. Using the wrong adaptor can result in damage to the instrument or overheating.
- Check the electric plug periodically and remove any dirt or dust which may have accumulated on it.

#### Do not open

- This instrument contains no user-serviceable parts. Do not open the instrument or attempt to disassemble or modify the internal components in any way. If it should appear to be malfunctioning, discontinue use immediately and have it inspected by qualified Yamaha service personnel.

#### Water warning

- Do not expose the instrument to rain, use it near water or in damp or wet conditions, place on it any containers (such as vases, bottles or glasses) containing liquids which might spill into any openings. If any liquid such as water seeps into the instrument, turn off the power immediately and unplug the power cord from the AC outlet. Then have the instrument inspected by qualified Yamaha service personnel.
- Never insert or remove an electric plug with wet hands.

#### Fire warning

- Do not put burning items, such as candles, on the unit. A burning item may fall over and cause a fire.



### CAUTION

Always follow the basic precautions listed below to avoid the possibility of physical injury to you or others, or damage to the instrument or other property. These precautions include, but are not limited to, the following:

#### Power supply/AC power adaptor

- Do not connect the instrument to an electrical outlet using a multiple-connector. Doing so can result in lower sound quality, or possibly cause overheating in the outlet.
- When removing the electric plug from the instrument or an outlet, always hold the plug itself and not the cord. Pulling by the cord can damage it.
- Remove the electric plug from the outlet when the instrument is not to be used for extended periods of time, or during electrical storms.

#### Battery

- Follow the precautions below. Failure to do so might result in explosion, fire, overheating or battery fluid leakage.
  - Do not tamper with or disassemble batteries.
  - Do not dispose of batteries in fire.
  - Do not attempt to recharge batteries that are not designed to be charged.
  - Keep the batteries separate from metallic objects such as necklaces, hairpins, coins, and keys.
  - Use the specified battery type (page 13) only.
  - Use new batteries, all of which are the same type, same model, and made by the same manufacturer.
  - Always make sure all batteries are inserted in conformity with the +/- polarity markings.
  - When the batteries run out, or if the instrument is not to be used for a long time, remove the batteries from the instrument.
  - When using Ni-MH batteries, follow the instructions that came with the batteries. Use only the specified charger device when charging.
- Keep batteries away from small children who might accidentally swallow them.
- If the batteries do leak, avoid contact with the leaked fluid. If the battery fluid should come in contact with your eyes, mouth, or skin, wash immediately with water and consult a doctor. Battery fluid is corrosive and may possibly cause loss of sight or chemical burns.

#### If you notice any abnormality

- When one of the following problems occur, immediately turn off the power switch and disconnect the electric plug from the outlet. (If you are using batteries, remove all batteries from the instrument.) Then have the device inspected by Yamaha service personnel.
  - The power cord or plug becomes frayed or damaged.
  - It emits unusual smells or smoke.
  - Some object has been dropped into the instrument.
  - There is a sudden loss of sound during use of the instrument.

#### Location

- Do not place the instrument in an unstable position where it might accidentally fall over.
- Before moving the instrument, remove all connected cables, to prevent damage to the cables or injury to anyone who might trip over them.

- When setting up the product, make sure that the AC outlet you are using is easily accessible. If some trouble or malfunction occurs, immediately turn off the power switch and disconnect the plug from the outlet. Even when the power switch is turned off, electricity is still flowing to the product at the minimum level. When you are not using the product for a long time, make sure to unplug the power cord from the wall AC outlet.
- Use only the stand specified for the instrument. When attaching the stand or rack, use the provided screws only. Failure to do so could cause damage to the internal components or result in the instrument falling over.

## Connections

- Before connecting the instrument to other electronic components, turn off the power for all components. Before turning the power on or off for all components, set all volume levels to minimum.
- Be sure to set the volumes of all components at their minimum levels and gradually raise the volume controls while playing the instrument to set the desired listening level.

Yamaha cannot be held responsible for damage caused by improper use or modifications to the instrument, or data that is lost or destroyed.

Always turn the power off when the instrument is not in use.

Even when the [  ] (Standby/On) switch is in standby status (display is off), electricity is still flowing to the instrument at the minimum level.

When you are not using the instrument for a long time, make sure you unplug the power cord from the wall AC outlet.

Make sure to discard used batteries according to local regulations.

## NOTICE

To avoid the possibility of malfunction/ damage to the product, damage to data, or damage to other property, follow the notices below.

### ■ Handling and Maintenance

- Do not use the instrument in the vicinity of a TV, radio, stereo equipment, mobile phone, or other electric devices. Otherwise, the instrument, TV, or radio may generate noise. When you use the instrument along with an application on your iPad, iPhone or iPod touch, we recommend that you set "Airplane Mode" to "ON" on that device in order to avoid noise caused by communication.
- Do not expose the instrument to excessive dust or vibrations, or extreme cold or heat (such as in direct sunlight, near a heater, or in a car during the day) to prevent the possibility of panel disfiguration, damage to the internal components or unstable operation. (Verified operating temperature range: 5° – 40°C, or 41° – 104°F)
- Do not place vinyl, plastic or rubber objects on the instrument, since this might discolor the panel or keyboard.
- When cleaning the instrument, use a soft, dry cloth. Do not use paint thinners, solvents, cleaning fluids, or chemical-impregnated wiping cloths.

### ■ Saving data

- Some data items (page 34) are automatically saved as backup data in the internal memory even if you turn the power off. Saved data may be lost due to malfunction or incorrect operation. Save important data to external device such as a USB flash memory (page 56).
- To protect against data loss through media damage, we recommend that you save your important data onto two USB flash memories.

## Information

### ■ About copyrights

- Copying of the commercially available musical data including but not limited to MIDI data and/or audio data is strictly prohibited except for your personal use.
- This product incorporates and bundles computer programs and contents in which Yamaha owns copyrights or with respect to which it has license to use others' copyrights. Such copyrighted materials include, without limitation, all computer software, style files, MIDI files, WAVE data, musical scores and sound recordings. Any unauthorized use of such programs and contents outside of personal use is not permitted under relevant laws. Any violation of copyright has legal consequences. DON'T MAKE, DISTRIBUTE OR USE ILLEGAL COPIES.

### ■ About functions/data bundled with the instrument

- Some of the preset songs and the optional songs have been edited for length or arrangement, and may not be exactly the same as the original.

### ■ About this manual

- The illustrations and LCD screens as shown in this manual are for instructional purposes only, and may appear somewhat different from those on your instrument.
- iPad, iPhone and iPod touch are trademarks of Apple Inc., registered in the U.S. and other countries.
- The company names and product names in this manual are the trademarks or registered trademarks of their respective companies.

## Handling caution

- Do not insert a finger or hand in any gaps on the instrument.
- Never insert or drop paper, metallic, or other objects into the gaps on the panel or keyboard. This could cause physical injury to you or others, damage to the instrument or other property, or operational failure.
- Do not rest your weight on, or place heavy objects on the instrument, and do not use excessive force on the buttons, switches or connectors.
- Do not use the instrument/device or headphones for a long period of time at a high or uncomfortable volume level, since this can cause permanent hearing loss. If you experience any hearing loss or ringing in the ears, consult a physician.

# Table of Contents

Special Features .....	6
Compatible Format and Functions .....	8
Included Accessories .....	8
About the Manuals .....	9

## Setting Up

<b>Panel Controls and Terminals</b> .....	<b>10</b>
<b>Setting Up</b> .....	<b>12</b>
Power Requirements .....	12
Connecting Headphones or External Audio Equipment .....	14
Connecting a Footswitch to the [SUSTAIN] jack .....	14
<b>Basic Operations</b> .....	<b>15</b>
Turning the Power On/Off .....	15
Auto Power Off Function .....	15
Selecting Operations .....	15
<b>Display Items</b> .....	<b>16</b>

## Quick Guide

<b>Try Playing a Variety of Instrument Voices</b> .....	<b>17</b>
Selecting a Main Voice .....	17
Playing the "Grand Piano" .....	17
Layering a Dual Voice .....	18
Playing a Split Voice in the Left Hand area .....	18
Using the Metronome .....	19
Adding Harmony .....	20
<b>Creating Arpeggios</b> .....	<b>21</b>
Triggering the Arpeggio .....	21
Changing the Arpeggio Type .....	21
<b>Creating Original Sounds via the Knobs</b> .....	<b>22</b>
Selecting a Knob Effect Combination .....	22
Applying the Filter to the Main Voice .....	22

<b>Playing Styles</b> .....	<b>23</b>
Using the Music Database .....	23
<b>Playing with Patterns Like a DJ!</b> .....	<b>24</b>
<b>Playing Songs</b> .....	<b>25</b>
Listening to a Demo Song .....	25
Selecting and Playing Back a Song .....	25
Song Fast Forward, Fast Reverse, and Pause .....	26
A-B Repeat .....	26
Turning Each Track On/Off .....	26
<b>Using the Song Lesson Feature</b> .....	<b>27</b>
Three Types of Song Lesson .....	27
Practicing with Song Lesson .....	27
Making Practice Perfect—Repeat & Learn .....	28
<b>Playing an External Audio Device with the Built-in Speakers</b> .....	<b>29</b>
Using the Melody Suppressor .....	29
<b>Recording Your Performance</b> .....	<b>30</b>
Track Structure of a Song .....	30
Quick Recording .....	30
Recording to a Specified Track .....	31
Clearing a User Song .....	32
Clearing a Specified Track from a User Song .....	32
<b>Memorizing Your Favorite Panel Settings</b> .....	<b>33</b>
Memorizing Panel Settings to the Registration Memory .....	33
Recalling Panel Settings from the Registration Memory .....	33
<b>Using with a Computer or iPad/iPhone</b> .....	<b>34</b>
Connecting to a computer .....	34
Connecting an iPad/iPhone .....	34
<b>Backup and Initialization</b> .....	<b>34</b>
Backup Parameters .....	34
Initialization .....	34

## Special Features

### Play a Variety of Instrument Voices

► Page 17

The instrument voice that sounds when you play the keyboard can be changed to violin, flute, harp, or any of an extensive range of voices.



### Arpeggio Function

► Page 21

Similar to the arpeggio functions provided on some synthesizers, this function automatically produces arpeggios (broken chords) when you simply play the appropriate notes on the keyboard.



### Convenient Melody Suppressor

► Page 29

When the sound of an external audio device is output through this instrument, you can cancel or lower the volume of the melody part of stereo playback with this function, and play the melody part yourself.



## Reference

<b>Handy Performance Features</b>	<b>35</b>
Selecting a Reverb Type .....	35
Selecting a Chorus Type .....	35
Pitch Controls—Transpose .....	36
Pitch Controls—Fine Tuning .....	36
Pitch Controls—the PITCH BEND wheel .....	36
Calling Up Optimum Panel Settings —One Touch Setting (OTS) .....	36
Changing the Touch Response of the Keyboard .....	37
Selecting an EQ Setting for the Best Sound .....	37
<b>Scale Tuning</b>	<b>38</b>
Selecting Scale .....	38
Setting the Base Note for Each Scale .....	38
Tuning Each Note to Create an Original Scale .....	39
<b>Voice Settings</b>	<b>40</b>
Selecting a Dual Voice .....	40
Selecting a Split Voice .....	40
Voice Editing .....	40
<b>Parameters Assigned to the Knobs</b>	<b>41</b>
<b>Arpeggio Settings</b>	<b>43</b>
Synchronizing an Arpeggio to Song/Style/Pattern Playback—Arpeggio Quantize .....	43
Holding the Arpeggio Playback via the Footswitch .....	43
<b>Styles (Auto Accompaniment) and Patterns</b>	<b>44</b>
Style Variations—Sections .....	44
Synchro Stop .....	45
Turning Each Track Of Style On/Off .....	45
Pattern Variations—Sections .....	46
Pattern Retrigger Function .....	46
Changing the Tempo .....	46
Tap Start .....	46

Adjusting the Volume of the Style or Pattern .....	47
Setting the Split Point .....	47
Playing Chords Without Style Playback .....	47
Chord Types for Style Playback .....	48
Looking Up Chords Using the Chord Dictionary .....	49
<b>Song Settings</b>	<b>50</b>
BGM (Background Music) Playback .....	50
Random Song Playback .....	50
Tempo Setting of the Song .....	51
Tap Start .....	51
Song Volume .....	51
Melody Voice Setting of the Preset Song .....	51
<b>The Functions</b>	<b>52</b>
Basic Procedure in the Function Display .....	52
<b>USB Flash Memory Operations</b>	<b>56</b>
Connecting a USB Flash Memory .....	57
Formatting a USB Flash Memory .....	58
Saving User Data to a USB Flash Memory .....	59
Saving a User Song as SMF to a USB Flash Memory .....	60
Loading User Data from a USB Flash Memory .....	60
Loading a Style File .....	61
Deleting a User File in the USB Flash Memory .....	62
Deleting a SMF File in the USB Flash Memory .....	62
Exiting from a File Control display .....	63

## Appendix

Troubleshooting .....	64
Specifications .....	65
Index .....	66

### Play Along with Styles

#### ► Page 23

The auto-accompaniment Styles provide the equivalent of a full backing band covering a wide variety of music genres. Select a Style that matches the music you want to play, or experiment with new Styles to expand your musical horizons.



### Create New Sounds

#### ► Page 22

By adjusting just two knobs you can add varying degrees of distortion, or other characteristics to the sound to enhance it subtly or change it dramatically.

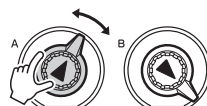

### Try playing like a DJ by using the Patterns!

#### ► Page 24

The Pattern function lets you perform like a DJ. Use the Track Control to try out various instrument combinations, and play with the Knobs to create various new sounds.





## Compatible Format and Functions



### GM System Level 1

“GM System Level 1” is an addition to the MIDI standard which ensures that any GM-compatible music data can be accurately played by any GM-compatible tone generator, regardless of manufacturer. The GM mark is affixed to all software and hardware products that support GM System Level.



### XGlite

As its name implies, “XGlite” is a simplified version of Yamaha’s high-quality XG tone generation format. Naturally, you can play back any XG song data using an XGlite tone generator. However, keep in mind that some songs may play back differently compared to the original data, due to the reduced set of control parameters and effects.



### USB

USB is an abbreviation for Universal Serial Bus. It is a serial interface for connecting a computer with peripheral Devices. It allows “hot swapping” (connecting peripheral devices while the power to the computer is on).



### STYLE FILE

The Style File Format is Yamaha’s original style file format which uses a unique conversion system to provide high-quality automatic accompaniment based on a wide range of chord types.

### About audio files

This instrument does not feature audio file playback or audio recording. Also, audio signals created via your keyboard performance cannot be transferred to the computer or iPad/iPhone even if one of them is connected to the USB [TO HOST] terminal of this instrument.

## Included Accessories

- Owner’s Manual (this book)
- Data List
- AC Power Adaptor\*<sup>1</sup>
- Music Rest
- Online Member Product Registration\*<sup>2</sup>

\*1: May not be included depending on your particular locale. Check with your Yamaha dealer.

\*2: The PRODUCT ID on the sheet will be needed when you fill out the User Registration form.

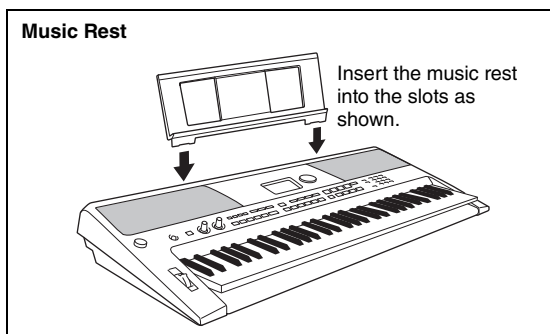



## About the Manuals

This instrument has the following documents and instructional materials.

### ■ Included Documents



#### Owner's Manual (this book)

- Setting Up Please read this section first.
- Quick Guide This section explains how to use the basic functions. Refer to this section while playing the instrument.
- Reference This section explains how to make detailed settings for the various functions of the instrument.
- Appendix This section includes troubleshooting information and specifications.



#### Data List

Contains various important preset content lists such as those of Voices, Styles, Patterns and Effects.

### ■ Online Materials (from Yamaha Downloads)



#### MIDI Reference

Contains MIDI related information such as MIDI Data Format and the MIDI Implementation Chart.



#### MIDI Basics (only in English, French, German and Spanish)

Contains basic explanations about MIDI.



#### Computer-related Operations

Includes instructions on connecting this instrument to a computer, and operations related to transferring song data.



#### iPhone/iPad Connection Manual

Explains how to connect the instrument to smart devices, such as iPhone, iPad, etc.

To obtain these manuals, access the Yamaha Downloads. Select your country, enter “PSR-E443” to the Model Name box, then click [SEARCH].

**Yamaha Downloads** <http://download.yamaha.com/>

### Online Materials (for Yamaha Online members)



#### Song Book (only in English, French, German, Spanish and Japanese)

Contains music scores for the preset Songs (excluding the Demo Songs) of this instrument and the optional Songs



#### Song Data

Contains the data of 70 Songs that can be played back with this instrument and/or used for the Song Lesson (Page 27).

After completing the user registration at the website below, you can download the Song Book and the Song Data free of charge.

**Yamaha Online Member** <https://member.yamaha.com/>

You will need the PRODUCT ID on the sheet (“Online Member Product Registration”) packaged with this manual in order to fill out the User Registration form.

\* The downloaded Song data can be played back by transferring data from the computer to the instrument or saving data to the USB flash memory. For instructions on Song playback, refer to “Selecting and Playing Back a Song” on page 25.

# Panel Controls and Terminals

## Front Panel

Display (page 16)

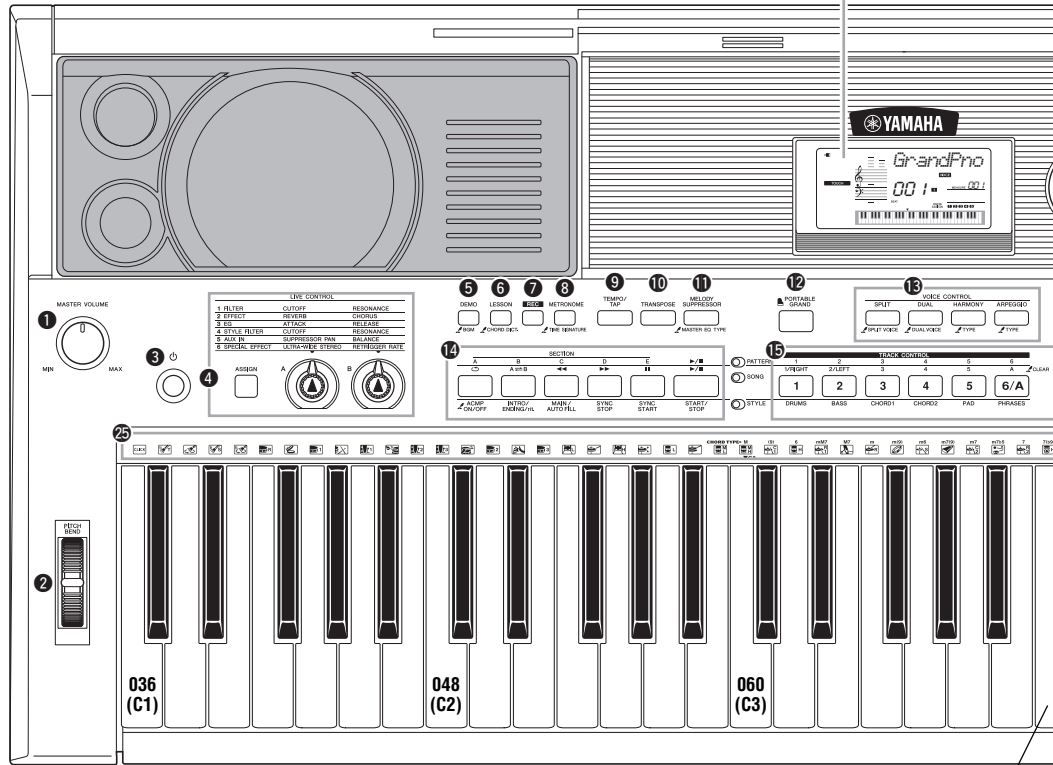

As illustrated above, each note of the keyboard has a specific note number and name (e.g., 036/C1), which is used in making various settings, such as Split Point.

072 (C4)

## Front Panel

- 1 [MASTER VOLUME] control ..... Page 15
- 2 PITCH BEND wheel ..... Page 36
- 3 [⏻] (Standby/On) switch ..... Page 15
- 4 LIVE CONTROL section
  - [ASSIGN] button ..... Page 22
  - [A] and [B] knobs ..... Page 22
- 5 [DEMO] button ..... Page 25
- 6 [LESSON] button ..... Page 27
- 7 [REC] button ..... Page 30
- 8 [METRONOME] button ..... Page 19
- 9 [TEMPO/TAP] button ..... Page 46
- 10 [TRANSPOSE] button ..... Page 36
- 11 [MELODY SUPPRESSOR] button ..... Page 29
- 12 [PORTABLE GRAND] button ..... Page 17
- 13 VOICE CONTROL section
  - [SPLIT] button ..... Page 18
  - [DUAL] button ..... Page 18
  - [HARMONY] button ..... Page 20
  - [ARPEGGIO] button ..... Page 21
- 14 Playback Control buttons
  - When the [PATTERN] lamp is turned on: ..... Pages 24 and 46
  - When the [SONG] lamp is turned on: ..... Page 26
  - When the [STYLE] lamp is turned on: ..... Pages 23, 44, and 45

Dial (page 15)      Style List (Data List)      Voice List (Data List)

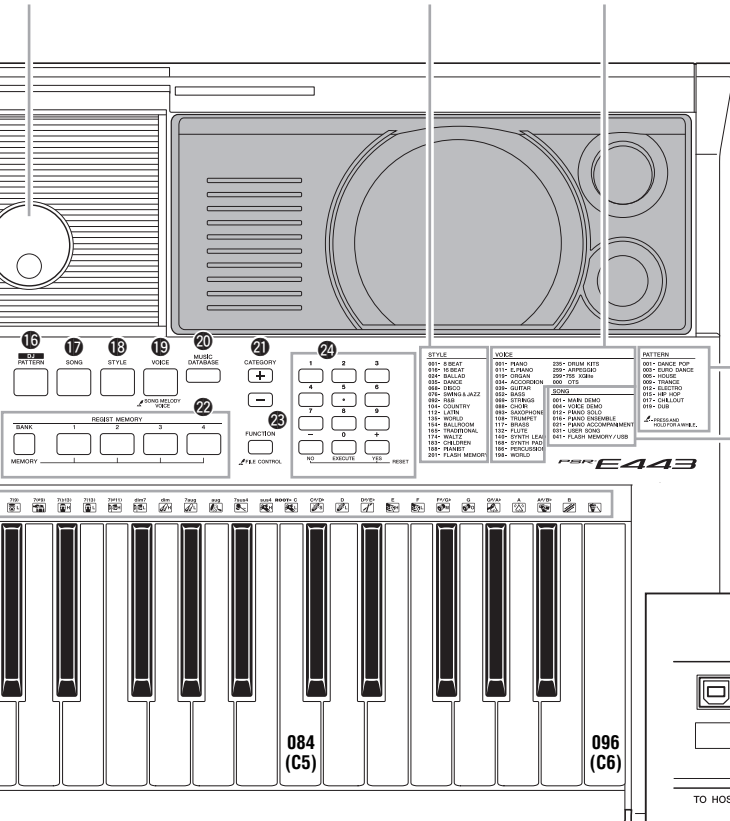

Pattern List (Data List)

Song List (Data List)

**“Press & Hold” symbol**

By holding down one of the buttons having this symbol, you can call up an alternate function, other than the one called up when simply pressing.

**Rear Panel**

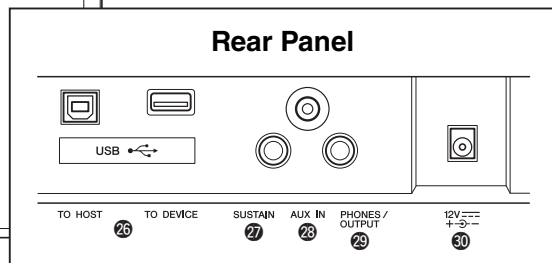

- 15 [TRACK CONTROL] buttons
  - When the [PATTERN] lamp is turned on: .....Page 24
  - When the [SONG] lamp is turned on: .....Page 26
  - When the [STYLE] lamp is turned on: .....Page 45
- 16 [PATTERN] button .....Page 24
- 17 [SONG] button .....Page 25
- 18 [STYLE] button .....Page 23
- 19 [VOICE] button .....Page 17
- 20 [MUSIC DATABASE] button .....Page 23
- 21 [CATEGORY] buttons .....Page 15
- 22 [REGIST MEMORY] buttons .....Page 33
- 23 [FUNCTION] button .....Page 52

- 24 Number buttons [1]–[9], [–/NO], [0/EXECUTE] and [+ /YES] buttons .....Page 15
- 25 Drum illustrations for the Drum Kit....Page 17
 

These indicate the drum or percussion instrument assigned to the corresponding keys (in the case of “Standard Kit 1,” shown in the Drum Kit List of the separate Data List).

**Rear Panel**

- 26 USB [TO HOST] terminal\* .....Page 54
- 27 USB [TO DEVICE] terminal .....Page 56
- 27 [SUSTAIN] jack .....Page 14
- 28 [AUX IN] jack .....Page 29
- 29 [PHONES/OUTPUT] jack .....Page 14
- 30 Power supply jack.....Page 12

\* For connecting to a computer. For details, refer to “Computer-related Operations” (page 9). When connecting, use an AB type USB cable of less than 3 meters. USB 3.0 cables cannot be used.

## Power Requirements

Although the instrument will run either from an optional AC adaptor or batteries, Yamaha recommends use of an AC adaptor whenever possible. An AC adaptor is more environmentally friendly than batteries and does not deplete resources.

### Using an AC Power Adaptor

- 1 Make sure that the power of the instrument is off (display is blank, except for notation staff).

#### WARNING

- Use the specified adaptor (page 65) only. Using the wrong adaptor can result in damage to the instrument or overheating.
- This adaptor is for indoor use only. Do not expose the instrument to rain, use it near water or in damp or wet conditions, or use it to hold any containers (such as vases, bottles or glasses) containing liquids which might spill into any openings.

- 2 Connect the AC adaptor to the power supply jack.
- 3 Plug the AC adaptor into an AC outlet.

#### CAUTION

- When setting up the product, make sure that the AC outlet you are using is easily accessible. If some trouble or malfunction occurs, immediately turn off the power switch and disconnect the plug from the outlet. Even when the power switch is turned off, electricity is still flowing to the product at the minimum level. When you are not using the product for a long time, make sure to unplug the power cord from the wall AC outlet.

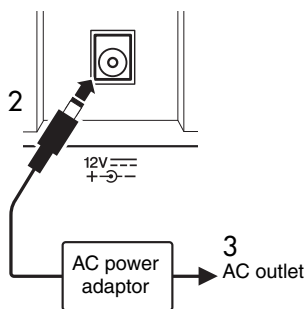

### ■ Notice for the AC adaptor

Depending on your particular locale, the AC adaptor having a separable plug should be used. In this case, make sure to follow the explanations below for your safety.

#### If the plug is accidentally removed from the AC adaptor

Without touching the metallic section, slide the plug into place as shown below then push it in completely until you hear the click sound.

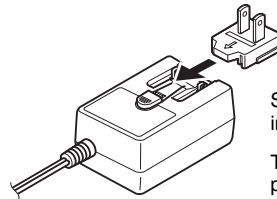

Slide the plug as indicated.

The shape of the plug differs depending on locale.

#### WARNING

- Make sure to keep the plug attached to the AC adaptor. Using the plug alone can cause electric shock or fire.
- Never touch the metallic section when attaching the plug. To avoid electric shock, short circuit or damage, also be careful that there is no dust between the AC adaptor and plug.

## Using Batteries

This instrument requires six “AA” size, Alkaline (LR6)/Manganese (R6) batteries, or rechargeable nickel-metal hydride batteries (rechargeable Ni-MH batteries). The Alkaline batteries or rechargeable Ni-MH batteries are recommended for this instrument, since other types may result in poorer battery performance.

### ⚠ WARNING

- When using Ni-MH batteries, follow the instructions that came with the batteries. Use only the specified charger device when charging.

### ■ Installing the batteries

- 1 Make sure that the power of the instrument is off (display is blank, except for notation staff).
- 2 Open the battery compartment cover located on the instrument’s bottom panel.

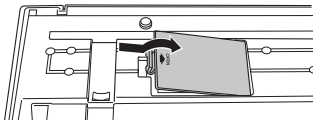

- 3 Insert the six new batteries, being careful to follow the polarity markings on the inside of the compartment.

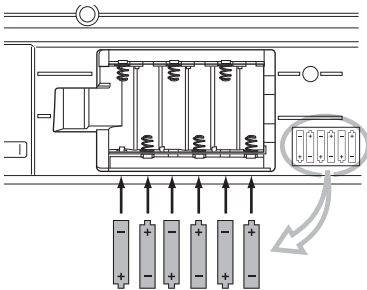

- 4 Replace the compartment cover, making sure that it locks firmly in place.

### NOTICE

- Connecting or disconnecting the power adaptor with batteries installed may turn the power off, resulting in loss of data being recorded or transferred at the time.

When battery power becomes too low for proper operation, the volume may be reduced, the sound may be distorted, and other problems may occur. When this happens, make sure to replace all batteries with new ones or already-recharged ones.

### NOTE

- This instrument cannot charge the batteries. Use only the specified charger device when charging.
- Power will be automatically drawn from the AC adaptor if an AC adaptor is connected while batteries are installed in the instrument.

### ■ Setting the battery type

After installing the new batteries then turning the power on, make sure to set the Battery Type to Rechargeable type or not. For details, refer to page 55.

### NOTICE

- Failure to set the Battery Type may shorten the amount of the battery life. Make sure to set the Battery Type correctly.



### ■ Checking the power status on the display

#### ● Power source on the display

You can confirm the power source at the left corner of the display.



Only one of these is shown.



When  is shown, the power is supplied from the AC power adaptor. When  is shown, the power is supplied from the batteries. When the AC power adaptor is connected with the batteries installed, the power is supplied from the AC power adaptor and the  indication is shown.

#### ● Remaining battery power indication

You can confirm the approximate amount of remaining battery power at the top left of the display.

	Indicates that the power will be turned off immediately. When rechargeable batteries are used, this icon flashes before the power is turned off.
	Indicates that remaining power is insufficient for operation. Before the power runs out, replace all the batteries with new ones, or fully recharged ones (when using rechargeable types). Note that the instrument may not work properly, including unusually soft volume and poor sound quality when remaining power becomes low.
	Indicates that the remaining power is sufficient.

## Connecting Headphones or External Audio Equipment

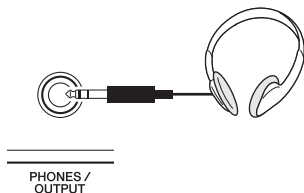

Any pair of stereo headphones with a 1/4" stereo phone plug can be plugged in here for convenient monitoring. The speakers are automatically shut off when a plug is inserted into this jack.

The [PHONES/OUTPUT] jack also functions as an external output. You can connect the [PHONES/OUTPUT] jack to a computer, keyboard amplifier, stereo system, mixer, tape recorder, or other line-level audio device to send the instrument's output signal to that device.

### CAUTION

- Do not use the instrument/device or headphones for a long period of time at a high or uncomfortable volume level, since this can cause permanent hearing loss. If you experience any hearing loss or ringing in the ears, consult a physician.
- Before connecting the instrument to other electronic components, set all volume levels to the minimum, then turn off the power for all components.

### NOTICE

- When the instrument's sound is output to an external device, first turn on the power to the instrument, then to the external device. Reverse this order when you turn the power off.

## Connecting a Footswitch to the [SUSTAIN] jack

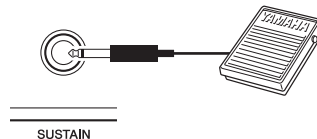

You can produce a natural sustain as you play by pressing an optional Footswitch plugged into the [SUSTAIN] jack. Make sure that the footswitch plug is properly connected to the [SUSTAIN] jack before turning on the power.

### NOTE

- The sustain function does not affect split voices (page 18).
- Do not press the footswitch while turning the power on. Doing this changes the recognized polarity of the footswitch, resulting in reversed footswitch operation.

# Basic Operations

## Turning the Power On/Off

Turn down the MASTER VOLUME control to “MIN” then press the [ ⏻ ] (Standby/On) switch to turn on the power. While playing the keyboard, adjust the MASTER VOLUME control. To turn off the power, press the [ ⏻ ] (Standby/On) switch again for a second.

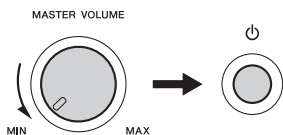

### CAUTION

- When using a power adaptor, even when the power is off, a small amount of electricity is still being consumed by the instrument. When you are not using the instrument for a long time, make sure to unplug the AC power adaptor from the wall AC outlet.

## Auto Power Off Function

To prevent unnecessary power consumption, this instrument features an Auto Power Off function that automatically turns the power off if the instrument is not operated for a specified period of time. The amount of time that will elapse before the power is automatically turned off is set by default to 30 minutes.

### To disable the Auto Power Off function:

Turn off the power, then press the [ ⏻ ] (Standby/On) switch to turn on the power while holding down the lowest key.

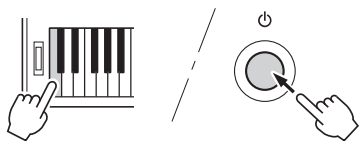

You can set the time that elapses before Auto Power Off is executed. For details, refer to the Function List (page 55).

### NOTE

- Generally, the data and settings are maintained even when the power is turned off. For details, see page 34.

### NOTICE

- Depending on the instrument status, the power may not turn off automatically, even after the elapse of the specified period of time. Always turn off the power manually when the instrument is not in use.

- When the instrument is not operated for a specified period of time while connected to an external device such as an amplifier, speaker or computer, make sure to follow the instructions in the Owner's Manual to turn off the power to the instrument and the connected devices, in order to protect the devices from damage. If you do not want the power to turn off automatically when a device is connected, disable Auto Power Off.

## Selecting Operations

Before operating the instrument, it may be helpful to familiarize yourself with the basic controls below that are used to select items and change values.

### Dial

Rotate the dial clockwise to increase the value, or counter-clockwise to decrease the value.

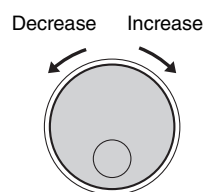

### Number buttons

Use the Number buttons to directly enter an item or value. For numbers that start with one or two zeroes, the first zeroes can be omitted.

**Example: Selecting Voice 003, Bright Piano.**

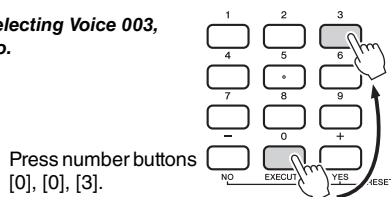

### [-/NO] and [+ /YES] buttons

Press the [+ /YES] button briefly to increase the value by 1, or press the [- /NO] button briefly to decrease the value by 1. Press and hold either button to continuously increase or decrease the value in the corresponding direction.

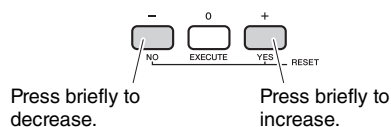

### CATEGORY buttons

Use these buttons to jump to the first Voice, Style, or Song in the next or previous Category, and call up the next or previous Function sequentially.



In most procedures described throughout this owner's manual the dial is recommended for selection simply because it is the easiest and most intuitive selection method. Please note however, that most items or values that can be selected using the dial can also be selected using the [+ /YES] and [- /NO] buttons.



# Display Items

The display shows all the current settings of the Song, Style Pattern, Voice and other related functions.

### Power source status

Indicates the source from which this instrument obtains power, AC power adaptor or batteries. (Page 13)



### USB connection status

Appears when USB flash memory is connected to this instrument. (Page 56)

USB

### Notation

Normally this indicates the notes you play. When the Song Lesson function is used, this indicates the current notes and chord of playback. When the Dictionary function is used, this indicates the notes of the chord you specify.



#### NOTE

- Any notes occurring below or above the staff are indicated by "8va."
- For a few specific chords, not all notes may be shown, due to space limitations in the display.

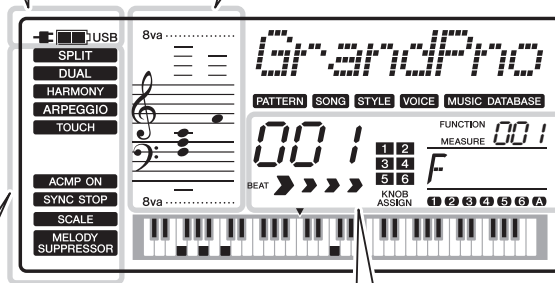

### On/off status

This area indicates the on/off status of each function. Each indication is shown when the corresponding function is turned on.

- SPLIT** Page 18
- DUAL** Page 18
- HARMONY** Page 20
- ARPEGGIO** Page 21
- TOUCH** Page 37
- ACMP ON** Page 23
- SYNC STOP** Page 45
- SCALE** Page 38
- MELODY SUPPRESSOR** Page 29

### Beat

Indicates the current beat of playback. (Page 25)



### Knob assignment

Indicates the parameters currently assigned to the Knobs. (Page 22)

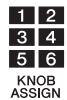

### FUNCTION and MEASURE

Indicates the Function number when the [FUNCTION] button is pressed, or the current Measure number during playback of a Song, Style or Pattern.



### Chord

Indicates the chord which is being played on the keyboard (Page 23) or specified via Song playback.



### Track status

Indicates the on/off status of the current Song, Style or Pattern. (Pages 24, 30, 45)



# Try Playing a Variety of Instrument Voices

In addition to piano, organ, and other “standard” keyboard instruments, this instrument has a large range of voices that includes guitar, bass, strings, sax, trumpet, drums and percussion, and even sound effects—giving you a wide variety of musical sounds.

## Selecting a Main Voice

### 1 Press the [VOICE] button.

The Voice number and name will be shown.  
For details, refer to the front panel or the Voice List of the separate Data List.

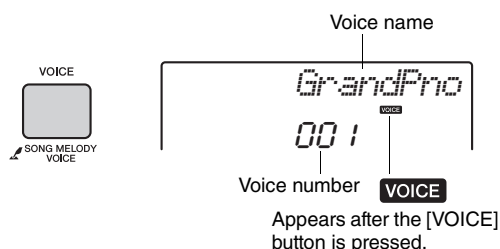

### 2 Use the dial to select the desired Voice.

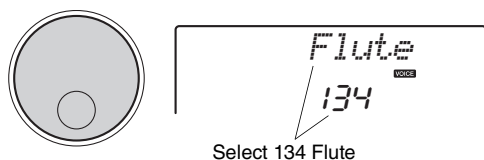

### 3 Play the keyboard.

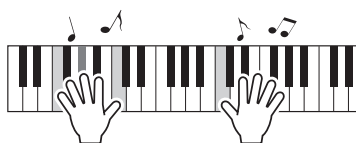

## Preset Voice Types

001–234	Instrument Voices.
235–258 (Drum Kit)	Various drum and percussion sounds are assigned to individual keys. Details on assigning instruments to keys are provided in the Drum Kit List of the separate Data List.
259–298	Used for arpeggio performance (page 21).
299–755	XGlite Voices.
000	Selecting this automatically calls up the most suitable Voice for the current Style, Song or Pattern. For details, see page 36.

## Playing the “Grand Piano”

When you want to reset various settings to default and simply play a Piano sound, press the [PORTABLE GRAND] button.



The Voice number is set to 001 Grand Piano and the settings such as Dual and Split are turned off automatically.

## Layering a Dual Voice

In addition to the Main Voice, you can layer a different Voice over the entire keyboard as a “Dual Voice.”

### 1 Press the [DUAL] button to turn Dual on.

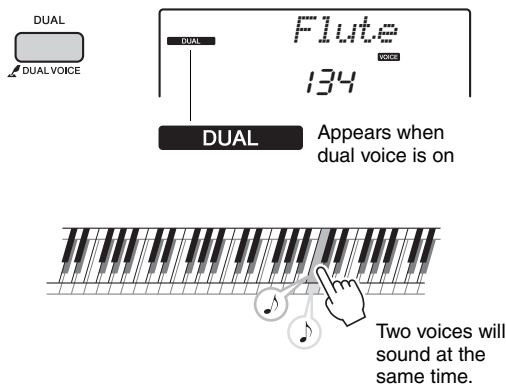

### 2 Press the [DUAL] button again to exit from Dual.

Although turning on Dual will select a Dual Voice suitable for the current Main Voice, you can easily select a different Dual Voice (page 40).

## Playing a Split Voice in the Left Hand area

By dividing the keyboard into the two separate areas, you can play a different Voice between the Left hand and Right hand areas.

### 1 Press the [SPLIT] button to turn on Split.

The keyboard is divided into the Left hand and Right hand areas.

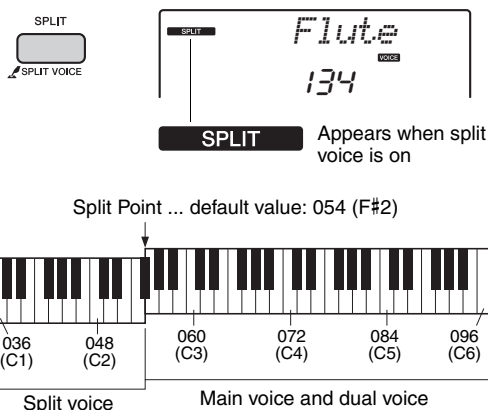

You can play a “Split Voice” on the Left hand area of the keyboard while playing a Main Voice and Dual Voice on the Right hand area of the keyboard.

The highest key for the Left hand area is referred to as the “Split Point” which can be changed from the default F#2 key. For details, refer to page 47.

### 2 Press the [SPLIT] button again to exit from Split.

You can easily select a different Split Voice (page 40).

## Using the Metronome

The instrument features a built-in metronome (a device that keeps an accurate tempo), convenient for practicing.

- 1 Press the [METRONOME] button to start the metronome.



- 2 Press the [METRONOME] button again to stop the metronome.

### Adjusting the Metronome Tempo

- 1 Press the [TEMPO/TAP] button to call up “Tempo.”

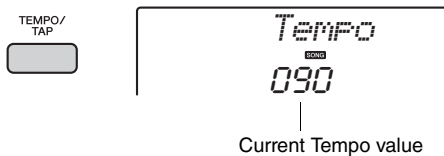

- 2 Adjust the Tempo value by rotating the dial.

### Setting the Time Signature

Here, we’ll set a time signature of 5/8 as an example.

- 1 Hold down the [METRONOME] button for longer than a second to call up “TimeSigN” (Time Signature Numerator).

The number of beats per measure is shown on the display.

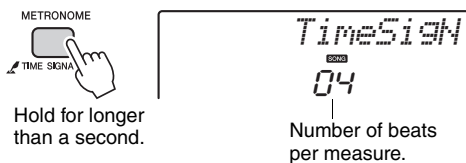

- 2 Rotate the dial to select the number of beats per measure.

A chime will sound on the first beat of each measure while the other beats will click. If “0” is selected, all beats will simply click with no chime. Select 5 for this example.

**NOTE**

- This parameter cannot be set during playback of a Style, Song or Pattern.

- 3 Press the CATEGORY [+] button to call up “TimeSigD” (Time Signature Denominator).

The length of one beat is shown on the display.

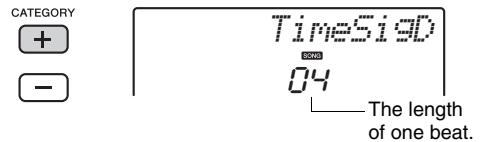

- 4 Rotate the dial to select the length of one beat, from 2<sup>nd</sup>, 4<sup>th</sup>, 8<sup>th</sup> and 16<sup>th</sup> note. Select “08” (8<sup>th</sup> note) for this example.

- 5 Confirm the setting by playing the Metronome.

### Setting the Metronome Volume

- 1 Press the [FUNCTION] button.



- 2 Press the CATEGORY [+] or [-] buttons repeatedly until “MtrVol” (Function 068) appears.

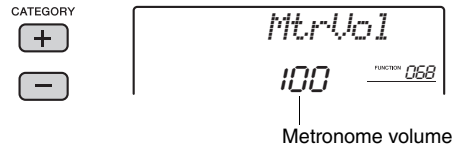

- 3 Rotate the dial to set the Metronome Volume.

## Adding Harmony

You can add harmony notes to the Main Voice.

- 1 Press the [HARMONY] button to turn Harmony on.

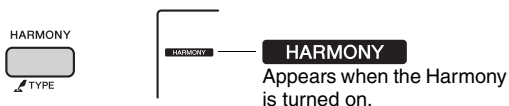

Although turning on the Harmony will select a Harmony Type suitable for the current Main Voice, you can select a different Harmony Type.

- 2 Hold down the [HARMONY] button for longer than a second until “HarmType” appears on the display.

After “HarmType” is shown for a few seconds, the current Harmony Type appears.

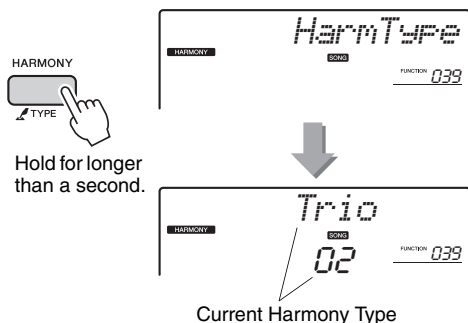

- 3 Rotate the dial to select the desired Harmony Type.

For details, refer to the Effect Type List of the separate Data List.

The effect and operation differs depending on the Harmony Type. Refer to “How to sound each Harmony Type” below.

- 4 Press the [HARMONY] button again to turn Harmony off.

### How to sound each Harmony Type

- Harmony type 01 to 05



Press the right-hand keys while playing chords in the auto accompaniment range of the keyboard when the Auto Accompaniment is on (page 23).

- Harmony type 06 to 12 (Trill)



Hold down two keys.

- Harmony type 13 to 19 (Tremolo)



Keep holding down the keys.

- Harmony type 20 to 26 (Echo)



Play the keys.

### Adjusting the Harmony Volume

You can adjust the Harmony Volume in the Function Settings (page 53).

# Creating Arpeggios

The Arpeggio function lets you create arpeggios (broken chords) by simply pressing the notes of the chord. For example, you could play the notes of a triad—the root, third, and fifth—to trigger interesting phrases. This feature can be used for music production as well as performance.

## Triggering the Arpeggio

- 1 Press the [ARPEGGIO] button to turn on the Arpeggio function.



### NOTE 1

- Selecting a Voice number between 259 and 298 will turn on Arpeggio automatically.

- 2 Press a note or notes to trigger Arpeggio.

The Arpeggio phrase differs depending on the number of pressed notes and the area of the keyboard.

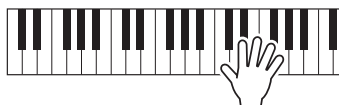

When Split is on, Arpeggio is applied only to the Split Voice. When Split is off, Arpeggio is applied to the Main and Dual Voices. Arpeggio cannot be applied to the Split and Main/Dual Voices simultaneously.

### NOTE 1

- Selecting a Voice number between 289 and 298 will turn on Split automatically, as well as Arpeggio. When one of those Voices is selected, Arpeggio is triggered only by playing a key to the left of the Split Point.
- When an optional Footswitch (page 14) connected to the SUSTAIN jack is pressed, the Arpeggio will continue to play after the note is released (page 43).

- 3 To turn off the Arpeggio, press the [ARPEGGIO] button again.

## Changing the Arpeggio Type

The most suitable Arpeggio Type is automatically selected when you select a Main Voice, but you can easily select any other Arpeggio Type.

- 1 Hold down the ARPEGGIO [TYPE] button for longer than a second.

In the display, “ARP Type” appears for a few seconds, followed by the current Arpeggio Type appears.

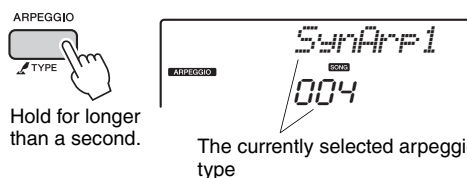

Hold for longer than a second.

The currently selected arpeggio type

- 2 Rotate the dial to select the desired Arpeggio type

An Arpeggio Type List is provided in the separate Data List.

# Creating Original Sounds via the Knobs

The two knobs located in the lower left area of the panel can be used to add variations to the sound being played, transforming the sound in a variety of musical ways. Select the desired pre-programmed effect combination printed above the Knobs, then rotate the Knobs to enjoy the sound.

## Selecting a Knob Effect Combination

Repeatedly press the [ASSIGN] button to sequentially select the five effect combinations provided: (1) → (2) → (3) → (4) → (5) → (6) → (1) ... etc. The current combination is shown in the display.

LIVE CONTROL		
1 FILTER	CUTOFF	RESONANCE
2 EFFECT	REVERB	CHORUS
3 EG	ATTACK	RELEASE
4 STYLE FILTER	CUTOFF	RESONANCE
5 AUX IN	SUPPRESSOR PAN	BALANCE
6 SPECIAL EFFECT	ULTRA-WIDE STEREO	RETRIGGER RATE



A



B

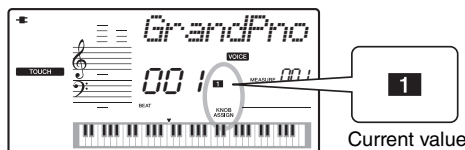

The target sound differs depending on the effect combination (selected number).

Effect Combination	Target Sound and Function
1 FILTER	Controls the sound of the Main Voice and Dual Voice.
2 EFFECT	
3 EG	
4 STYLE FILTER	Controls the sound of the Style (page 23) or Pattern (page 24)
5 AUX IN	Controls mainly audio sound coming from an external audio device connected to the AUX IN jack. * Knob B can be used to control the volume of Style/Song/Pattern sound with the keyboard sound maintained, even if an external audio device is not connected.
6 SPECIAL EFFECT	Knob A controls the entire sound while Knob B controls only the Pattern sound.

For details about each Knob effect, refer to page 41.

### NOTE

- Only selecting a Knob effect combination will not affect the sound even if the Knob arrow is not at the initial position. After operating the Knob, the selected effect is applied to the sound.

## Applying the Filter to the Main Voice

- Select the desired Main Voice.**  
Here, select “Voice No.153 SquareLd” (Square Lead) as a synth-lead type Voice.
- Press the [ASSIGN] button several times until (1) (Filter) appears in the display.**
- Rotate Knob B all the way to the right (maximum), then play the keyboard with your right hand while operating Knob A with your left.**

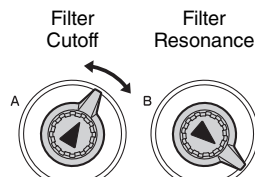

### NOTICE

- When **1** or **2** or **3** appears in the display by pressing [ASSIGN] button, selecting a different Voice will replace the settings created via the Knobs with the default settings of the new Voice. If you create a sound with the Knobs that you wish to keep, make sure to memorize the settings to Registration Memory (page 33) before selecting a different Voice.

### NOTE

- Rotating a Knob to the right while the volume is set to a high level may result in distortion. If this occurs, reduce the volume level.



# Playing Styles

This instrument includes the Auto Accompaniment feature that plays appropriate “Styles” (rhythm + bass + chord accompaniment). You can select from a huge variety of Styles covering a wide range of musical genres.

## 1 Press the [STYLE] button, then use the dial to select the desired Style.

The Style List is provided on the front panel, or in the Data List (page 9).

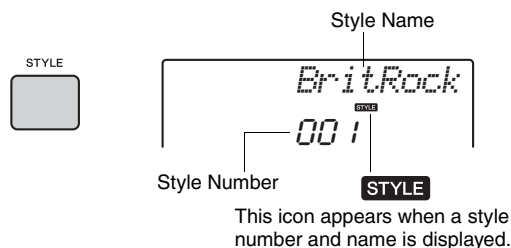

## 2 Press the [ACMP ON/OFF] button to turn on the Auto Accompaniment.

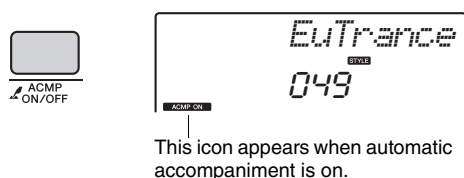

With this operation, the area of the keyboard to the left of the Split Point (054: F#2) becomes the “Auto Accompaniment range” and is used only for specifying the chords.

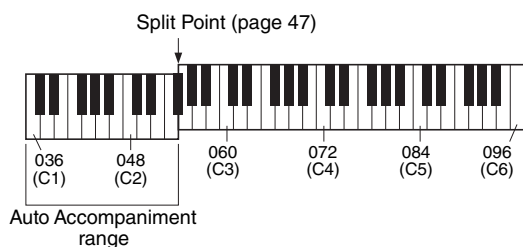

## 3 Press the [SYNC START] button to turn Synchro Start on.

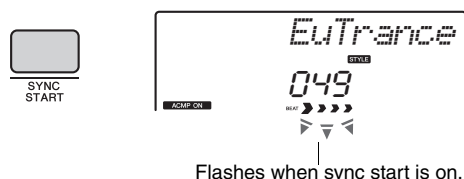

## 4 Play a chord in the Auto Accompaniment range to start playback.

Play a melody with the right hand and chords with the left hand.

For information about chords, refer to “Chord List” (page 48) or use the Chord Dictionary function (page 49).

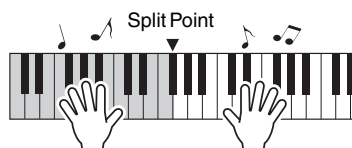

## 5 Press the [START/STOP] button to stop playback.

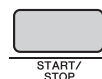

You can add intro, ending and rhythm variations to Style playback by using “Sections.” For details, refer to page 44.

## Using the Music Database

If you have difficulty finding and selecting the desired Style and Voice, use this feature. From the Music Database, just selecting the favorite music genre calls up the ideal settings.

### 1 Press the [MUSIC DATABASE] button.

Both the Auto Accompaniment and Synchro Start are automatically turned on.

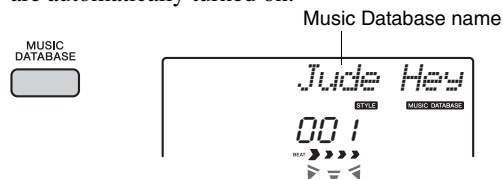

### 2 Use the dial to select the desired Music Database.

This operation calls up the panel settings such as Voice and Style that are registered to the selected Music Database. The Music Database List is provided in the Data List (page 9).

### 3 Play the keyboard as described in Steps 4–5 above.

# Playing with Patterns Like a DJ!

The Pattern playback function lets you repeatedly play various rhythm patterns, and is particularly effective in Hip-Hop, House music, etc. Try out the cool DJ-like performance features—changing keys in the left-hand area of the keyboard and rotating the Knobs for dynamic sound variations.

## 1 Press the [PATTERN] button, then use the dial to select the desired Pattern.

The ACMP is turned on, and the keyboard is divided into the accompaniment area (page 23) and melody area.

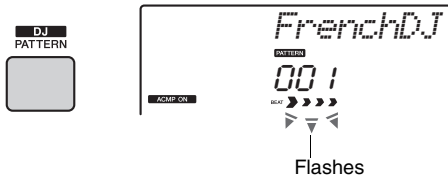

## 2 Press the [START/STOP] button or press any key to left of the Split Point (page 47) to start Pattern playback.

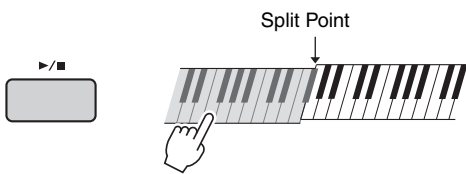

During Pattern playback, enjoy creating sound variations via the following operations.

### ● Turning on/off individual tracks via the [TRACK CONTROL] buttons

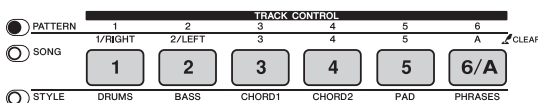

1 2 3 4 5 6 — On/off status is shown in the display (page 16)

#### NOTE

- Up to two Track buttons can be pressed simultaneously for turning on or off.

### ● Changing the Pattern Section via the [A]–[E] buttons

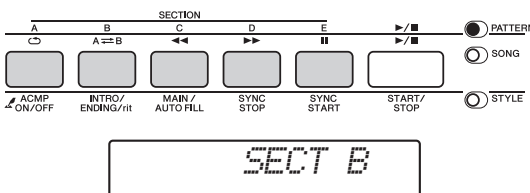

### ● Using Retrigger function (page 46)

Pressing the button of the currently playing Section restarts playback from the beginning. Holding down the button lets you loop-play only the top portion of the Section.

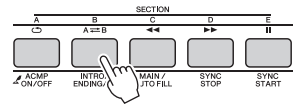

### ● Transposing playback by pressing any note to the left of the Split Point (page 47)

Unlike with the Styles, only the Root can be specified; the Chord Type cannot be specified.

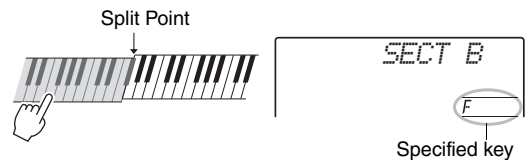

### ● Changing the sound via the Knobs

Press the [ASSIGN] button several times to select “4 STYLE FILTER” then rotate the Knobs A and B.

LIVE CONTROL		
1 FILTER	CUTOFF	RESONANCE
2 EFFECT	REVERB	CHORUS
3 EG	ATTACK	RELEASE
4 STYLE FILTER	CUTOFF	RESONANCE
5 AUX. B	SUPPRESSOR PAN	BALANCE
6 SPECIAL EFFECT	ULTRA-WIDE STEREO	RETRIGGER RATE



### ● Applying the Arpeggio to the right-hand area

Press the [ARPEGGIO] button to turn it on, then press the notes in the right-hand area of the keyboard.



#### NOTE

- When you select a Voice between 289 and 298, Arpeggio is applied only to the Split Voice. Playing a key to the left of the Split Point turns Arpeggio on as well as specifies the key for Pattern playback.

## 3 Press the [START/STOP] button to stop playback.

# Playing Songs

You can simply enjoy listening to the internal Songs, or use them with just about any of the functions, such as Lesson.

## ● Song Category

The Songs are organized by category as listed below.

### SONG

- |                          |   |
|--------------------------|---|
| 001- MAIN DEMO           | • Gives you an idea of the advanced capabilities of this instrument.                                  |
| 004- VOICE DEMO          | • Demonstrates many useful Voices of this instrument.   |
| 012- PIANO SOLO          | • These piano solo pieces are ideally suited for the Song Lesson.                                     |
| 016- PIANO ENSEMBLE      | • These piano ensemble pieces are also well suited for the Song Lesson.                               |
| 021- PIANO ACCOMPANIMENT | • When you need to practice backing (accompaniment) patterns, these songs are ideal for that purpose. |
| 031- USER SONG           | • Songs you record yourself.  |
| 041- FLASH MEMORY / USB  | • FLASH MEMORY: Songs transferred from a computer.<br>• USB: Songs in the USB flash memory.           |

These songs are shown in the display in the following sequence: Songs transferred from a computer, Songs in the USB flash memory. To transfer Songs from a computer to this instrument, refer to "Computer-related Operations" (page 9). For Songs in USB flash memory, refer to page 58.

### About audio files

Among Song formats, only MIDI files can be played back by this instrument. Audio files cannot be played back (or shown as Song numbers), even if they are saved in the USB flash memory connected to the USB [TO DEVICE] terminal.

### NOTE

- In addition to the 30 Preset Songs in this instrument, you can enjoy Optional Songs downloadable from the Yamaha website. For details, refer to page 9.
- When you transfer a Song from a computer while the USB flash memory is connected to the USB [TO DEVICE] terminal, the transferred Song will be inserted before the first USB Song number, moving all USB Song numbers later in sequence.

## Listening to a Demo Song

Press the [DEMO] button to play Songs in sequence. Playback will repeat continuously, starting again from the first Song (001).



To stop playback, press the [DEMO/BGM] or [START/STOP] button.

## Selecting and Playing Back a Song

- 1 Press the [SONG] button, then use the dial to select the desired Song.

Refer to the Song List in the Data List (page 9). You can select User Songs, Songs transferred from a computer, and Songs in USB flash memory in the same way as above.

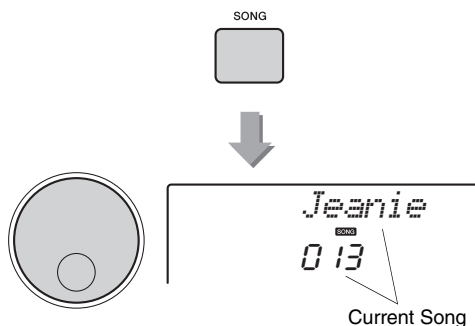

- 2 Press the [▶/■] (Start/Stop) button to start playback.

To stop playback, press the [▶/■] (Start/Stop) button again.

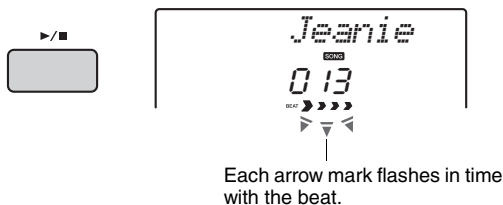

### NOTE

- External MIDI Songs containing the Portamento Control and Scale Tune settings may not be played correctly.

## Song Fast Forward, Fast Reverse, and Pause

Like the transport controls on an audio player, this instrument lets you fast forward [▶▶] (Fast Forward), rewind [◀◀] (Fast Reverse) and pause [⏸] (PAUSE) playback of the Song.

**Fast Forward**  
During playback, press this button to rapidly skip ahead to a later point in the Song.

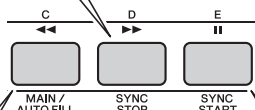

**Fast Reverse**  
During playback, press this button to rapidly return to an earlier point in the Song.

**Pause**  
During playback, press this button to pause playback, and press again to start from that point.

- NOTE**
- When the A-B repeat is specified, the Fast Reverse and Fast Forward will only work within the range between A and B.
  - [REW], [FF] and [PAUSE] button cannot be used during Song playback by using the [DEMO] button.

## A-B Repeat

You can play back only a specific section of a Song repeatedly by setting the A point (start point) and B point (end point) in one-measure increments.



- Start playback of the Song (page 25).
- When playback reaches to the point you want to specify as the start point, press the [A⇌B] (A-B REPEAT) button to set the A point.



- When playback reaches to the point you want to specify as the end point, press the [A⇌B] (A-B REPEAT) button again to set the B point.

The specified A-B section of the song will now play repeatedly.

- To cancel repeat playback, press the [A⇌B] (A-B REPEAT) button again. To stop playback, press the [START/STOP] button.

- NOTE**
- If you want to set the start point "A" at the top of the Song, press the [A⇌B] (A-B REPEAT) button before starting playback.

## Turning Each Track On/Off

Each "track" of a Song plays a different part—melody, percussion, accompaniment, etc. Each of the tracks can be muted so that you can play the muted part yourself. Pressing the desired Track button repeatedly will toggle the on/off status.

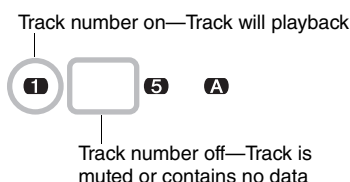
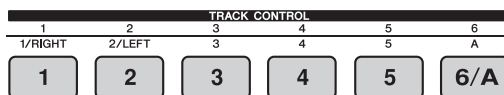

- NOTE**
- Up to two Track buttons can be pressed simultaneously for turning on or off.

# Using the Song Lesson Feature

You can use the selected Song for a left-hand, right-hand, or both-hands lesson. Try practicing with these three Song Lesson types while referring to the music scores in the Song Book (page 9).

## Three Types of Song Lesson

### Lesson 1—Listen

In this Lesson, you need not play the keyboard. The model melody/chords of the part you selected will sound. Listen to it carefully and remember it well.



### Lesson 2—Timing

In this mode, simply concentrate on playing the notes with the correct timing. Even if you play wrong notes, the correct notes shown in the display will sound



### Lesson 3—Waiting

In this Lesson, try playing the correct notes shown on the display. The Song pauses until you play the right note, and playback tempo will change to match the speed at which you are playing at.



#### NOTE

- If you want to keep a steady playback tempo is maintained during Lesson 3: Waiting, set the Your Tempo parameter (page 54) to OFF.

## Practicing with Song Lesson

### 1 Select the desired Song for your lesson (page 25).

#### NOTE

- The Song Lesson can be applied to Songs downloaded at the Yamaha website (page 9), Songs transferred from a computer, and Songs in USB flash memory (SMF format 0 only). However, some of the Lesson functions may not be applied to some Songs due to the structure of the Song data.
- The Song Lesson cannot be applied to the User Songs.

### 2 Turn off the part you want to practice.

For the right-hand lesson, press the [1/RIGHT] button to turn off the right-hand part. For the left-hand lesson, press the [2/LEFT] button to turn off the left-hand part. For the lesson using both hands, turn off both the parts.

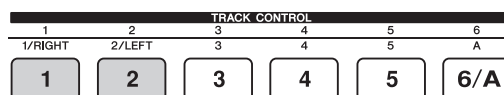

Pressing the [1/RIGHT] and [2/LEFT] buttons repeatedly will toggle the on/off status of each part, which can be shown on the display.

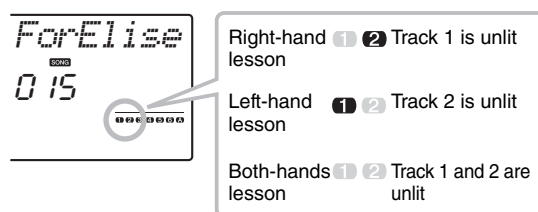

### 3 Press the [LESSON] button to start playback of the Song Lesson.

After starting playback, pressing the [LESSON] button repeatedly will change the Lesson number from 1: LISTEN → 2: TIMING → 3: WAITING → off → 1... Press this button until the desired number is shown on the display.

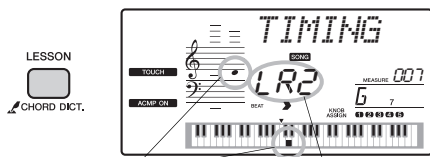

The notation and key positions you should play are shown.

Both-hands lesson 2 (TIMING) is indicated as shown. Right-hand lesson 2 is indicated as "R2" and Left-hand lesson 2 is indicated as "L 2."

To stop Lesson playback, press the [START/STOP] button.

Even during playback, you can change the Lesson number by pressing the [LESSON] button.

#### 4 When Lesson playback reaches to the end, check your evaluation Grade on the display.

"2 Timing" and "3 Waiting" will evaluate your performance in four levels: OK, Good, Very Good, or Excellent.

##### See How You've Done

Excellent ██████████

Very Good ████████

Good ██████

OK ████

When the lesson song has played all the way through your performance will be evaluated in 4 levels: OK, Good, Very Good, or Excellent. "Excellent!" is the highest evaluation.

After the evaluation display has appeared, the lesson will start again from the beginning.

## Making Practice Perfect—Repeat & Learn

If you want to practice a specific section in which you made a mistake or you have difficulty with use the Repeat & Learn function.

Press the [↶] (REPEAT & LEARN) button during a Lesson playback.



The Song location will move back four measures, a one-measure count will play, then Song playback will start again. Playback of the four measures will repeat with a one-measure count-in.

To exit from this status, press this button again.

##### NOTE

- You can change the amount of measures the Repeat & Learn function jumps back by pressing a number button [1]–[9] during repeat playback.

# Playing an External Audio Device with the Built-in Speakers

You can output the sound of an external audio device, such as a portable music player, with the built-in speakers of this instrument by connecting it via a cable. This lets you play the keyboard along with playback of your music player.

**1 Turn off the power for both the external audio device and this instrument.**

**2 Connect the audio device to the instrument's [AUX IN] jack.**

Use the cable which has the stereo-mini plug at one side for connecting to this instrument and the plug matching the output jack of the external audio device at the other side.

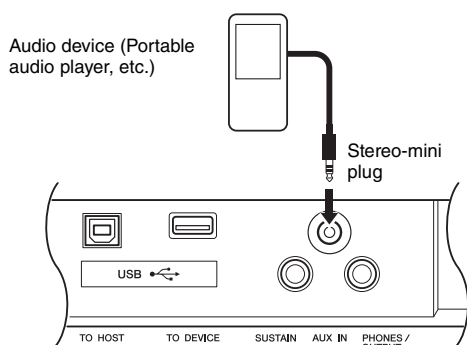

**3 Turn on the external audio device, then this instrument.**

**4 Play back the connected external audio device.**

The sound of the audio device is output through the speakers of this instrument.

**5 Adjust the volume balance between the audio device and this instrument.**

Do this by adjusting both the volume of the audio device and this instrument itself.

#### NOTE

- When you want to adjust the volume balance between the audio device and this instrument further, after the volume of each has been adjusted, press the [ASSIGN] button to call up **5**, then rotate the Knob B (page 41). The knob B can adjust only the volume of the audio device and Song/Style/Pattern playback sound.
- When you want to adjust the volume balance more, even after having adjusted it with Knob B, adjust the volume of the audio device using the function of this instrument. Press the [FUNCTION] button, and hold down the CATEGORY [+ ] or [- ] button until "AuxInVol" appears. Then, set the value of the volume with the dial. In case of adjusting the volume to more than 100, the audio device sound can become distorted.

**6 Play the keyboard along with the sound of the audio device.**

**7 After finishing the performance, stop playback of the audio device.**

#### CAUTION

- Before connecting, turn off the power of both this instrument and the external audio device. Also, before turning the power on or off, make sure to set all volume levels to minimum (0). Otherwise, damage to the devices, electrical shock, or even permanent hearing loss may occur.

#### NOTICE

- After connecting, first turn on the power to the external audio device then to this instrument. Reverse this order when you turn the power off.

## Using the Melody Suppressor

When the sound of an external audio device is output through this instrument, you can cancel or lower the volume of the melody part of stereo playback. You can use the function to cancel the melody part then practice it via the keyboard.

**1 Play back the connected external audio device.**

**2 Press the [MELODY SUPPRESSOR] button to turn it on.**

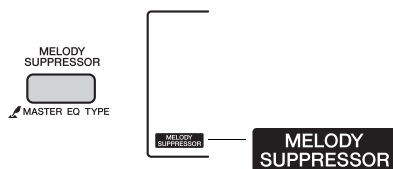

**3 Press the [ASSIGN] button to call up **5**. Then, adjust the pan position of the sound to be cancelled with Knob A (page 41).**

#### NOTE

- Depending on the particular music source, the melody or vocal sound may not be cancelled as expected even if the Melody Suppressor is turned on.

**4 Press the [MELODY SUPPRESSOR] button again to turn it off.**



# Recording Your Performance

You can record up to 10 of your performances as User Songs. The recorded User Songs can be played back on the instrument.

**NOTE**

• **About audio files**

The Recording function of this instrument will record your keyboard performance as MIDI data. Note that audio recording is not available.

## Track Structure of a Song

● **Melody Tracks [1]–[5]**

The melody performance of the keyboard will be recorded.

● **Accompaniment Track [A]**

The chord progression (for the Style) or the key change (for the Pattern) will be recorded.

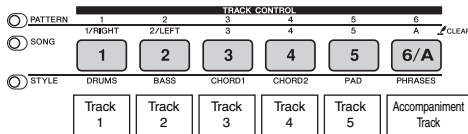

## Quick Recording

The operation is useful when you record a new Song from scratch.

- 1 **Make the desired settings including the Main Voice selection.**
- 2 **Make the desired settings of your performance.**
  - If you want to record only the melody performance, press the [SONG] button.
  - If you want to record the performance using a Style, press the [Style] button.
  - If you want to record the performance using a Pattern, press the [Pattern] button.
- 3 **Press the [REC] button to enter the Record Ready mode.**

If a User Song was not selected beforehand, this operation selects the lowest-numbered unrecorded User Song (from 031–040) as Recording target.

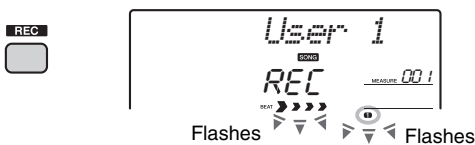

To exit from this status, press the [REC] button again.

**NOTE**

- The ACMP on/off status cannot be changed after the [REC] button is pressed.

## 4 Start recording.

- When you press the [SONG] button in Step 2, play any note to start recording.
- When you select a Style in Step 2, play a chord in the Auto Accompaniment area to start recording with Style playback, or press the [START/STOP] button to start recording only with playback of the Rhythm part of a Style.
- When you select a Pattern in Step 2, play a key in the Accompaniment area or press the [START/STOP] button to start recording with Pattern playback.



Current measure number

The current measure will be shown on the display while recording.

## 5 Press the [START/STOP] or [REC] button to stop recording.

When using a Style, you can stop recording also by pressing the [ENDING] button then waiting until playback ends.



After recording finishes, “Writing!” appears indicating that the recorded data will be stored, then the recorded track numbers in the display will light.

**NOTICE**

- Never attempt to turn the power off when “Writing!” is shown in the display. Doing so can damage the flash memory and result in a loss of data.

## 6 To play back the recorded Song, press the [START/STOP] button.

**NOTE**

• **When recording Pattern playback with Retrigger**

Note that the beat indicator in the display, metronome and Arpeggio playback is not synchronized with playback of the recorded Song.

## Recording to a Specified Track

The operation here is useful especially when you want to record the additional performances to an already recorded Song.

- 1 Press the [SONG] button, then select the desired User Song (031–040) as the recording target.

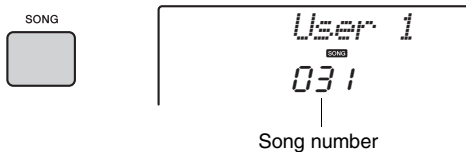

- 2 While holding down the [REC] button, press the desired Track button to enter the Record Ready mode.

- If you want to record only the melody:  
While holding down the [REC] button, press one of the [1]–[5] buttons.

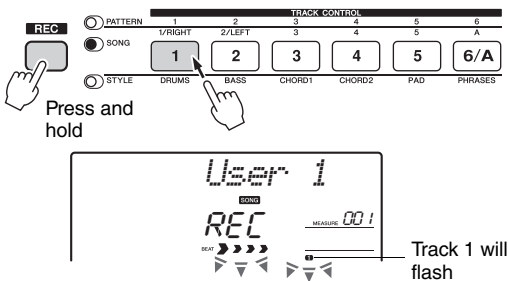

- If you want to record only the Style playback:

Press the [STYLE] button, select the desired Style, then simultaneously hold down the [REC] button and press the [6/A] button. ACMP is automatically turned on.

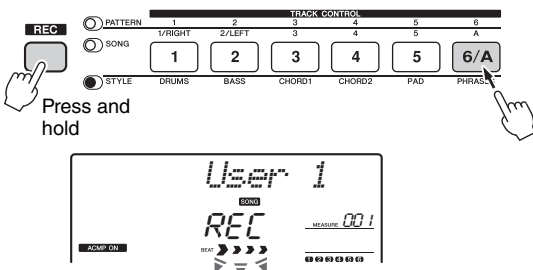

- If you want to record only the Pattern playback:

Press the [Pattern] button, then select the desired Pattern. While holding down the [REC] button, press the [6/A] button. ACMP is automatically turned on.

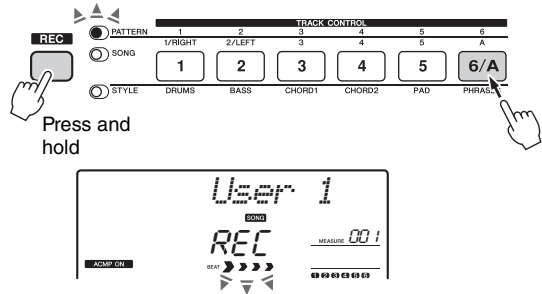

- 3 Same as in Steps 4 to 6 (page 30) in “Quick Recording.”

### NOTE

- If the memory becomes full while recording, an alert message will appear and recording will stop automatically. In this case, delete unnecessary data by using the Clear functions (page 32), then execute the recording again.

### Limitations while recording

- The on/off status of ACMP cannot be changed.
- Playback cannot be changed between Style and Pattern.
- The Pattern number can be changed while the Style number cannot.
- When you use a Style/Pattern, the following parameters cannot be changed: Reverb Type, Chorus Type, Time Signature, Style number and Style/Pattern Volume.
- Performance with a Split Voice cannot be recorded.
- The sound of an external audio device (page 29) cannot be recorded.

## Clearing a User Song

You can clear all tracks of a User Song.

- 1 Press the [SONG] button, then select the User Song (031–040) to be cleared.
- 2 Hold down the track [6/A] and [1] buttons simultaneously for longer than a second.

A confirmation message will appear on the display.

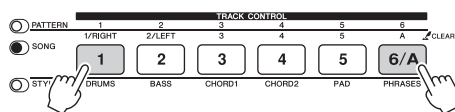

- 3 Press the [+ / YES] button.  
A confirmation message will appear on the display. To cancel this operation, press the [-] button.
- 4 Press the [+ / YES] button to clear the Song.  
A clear-in-progress message will appear briefly on the display.

## Clearing a Specified Track from a User Song

This lets you clear individual tracks from a User Song.

- 1 Press the [SONG] button, then select the desired User Song (031–040).
- 2 From [1]–[5] and [6/A], press the Track button to be cleared for longer than a second.

A confirmation message will appear on the display.

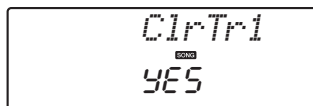
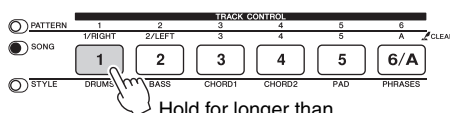

- 3 Press the [+ / YES] button.  
A confirmation message will appear on the display. To cancel this operation, press the [-] button.
- 4 Press the [+ / YES] button to clear the track.  
A clear-in-progress message will appear briefly on the display.

# Memorizing Your Favorite Panel Settings

This instrument has a Registration Memory feature that lets you memorize your favorite settings for easy recall whenever they're needed. Up to 32 complete setups can be saved (eight banks of four setups each).

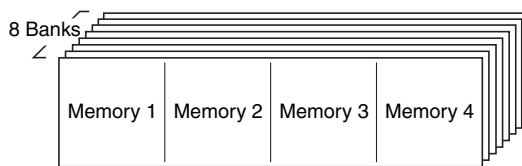

Up to 32 presets (eight banks of four each) can be memorized.

## Memorizing Panel Settings to the Registration Memory

- 1 Make the desired settings such as those for Voice, Style, and Pattern.
- 2 Press and release the [MEMORY/BANK] button to call up a Bank number on the display.

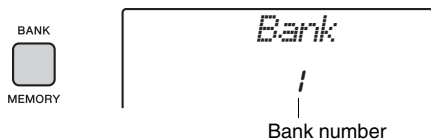

- 3 Use the dial or the [1]–[8] number buttons to select a Bank number.

**NOTE**

- Data cannot be saved to the Registration Memory during Song playback.

- 4 While holding down the [MEMORY/BANK] button, press one of the [1]–[4] buttons to memorize the current panel settings.

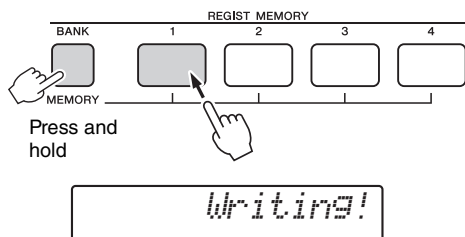

**NOTICE**

- If you select a Registration Memory number that already contains data, the previous data is deleted and overwritten by the new data.
- Do not turn off the power while memorizing settings to the Registration Memory, otherwise the data may be damaged or lost.

## Recalling Panel Settings from the Registration Memory

- 1 Press and release the [MEMORY/BANK] button to call up a Bank number on the display.
- 2 Use the dial or the [1]–[8] number buttons to select a Bank number.
- 3 Press one of the [1]–[4] buttons to call up the panel settings you memorized. The recalled REGIST MEMORY number appears in the display for a few seconds.

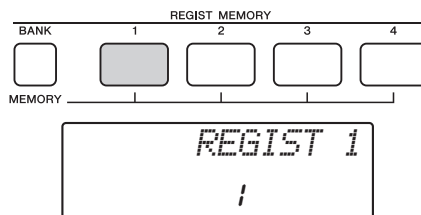

**NOTE**

- When the [SONG] lamp is lit, the Style or Pattern settings will not be recalled even if you press the Registration Memory button to which the Style or Pattern settings are memorized. To recall Style/Pattern settings, make sure to press the [STYLE] or [PATTERN] button.

### Parameters that can be memorized to Registration Memory

- **Style settings**  
Style number, ACMP on/off, Style volume, Track on/off
- **Pattern settings**  
Pattern number, Pattern volume, Section, Track on/off
- **Voice settings**  
**Main Voice settings:** Voice number and all settings of the related Functions  
**Dual Voice settings:** Dual on/off and all settings of the related Functions  
**Split Voice settings:** Split on/off and all settings of the related Functions
- **Effect settings**  
Reverb Type, Chorus Type
- **Arpeggio settings**  
Arpeggio on/off and all settings of the related Functions
- **Harmony settings**  
Harmony on/off and all settings of the related Functions
- **Other settings**  
Transpose, Pitch Bend Range, Knob Effect Combination number, Split Point, Tempo, Scale Tune

# Using with a Computer or iPad/iPhone

## Connecting to a computer

This instrument supports MIDI (Musical Instrument Digital Interface) and can transmit/receive keyboard performance information (MIDI messages) or Song/Style data (MIDI files) to/from the computer connected via a USB cable. For details on using a computer with this instrument, refer to the “Computer-related Operations” (page 9) on the website.

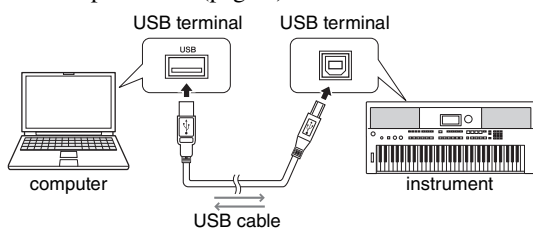

### NOTE

- If you transfer the Style file from the computer to this instrument, you need to register it to this instrument for Style playback. For details, refer to “Loading a Style File” (page 61).

### About audio files

Audio signals created via your keyboard performance cannot be transferred to a computer or iPad/iPhone even if such a device is connected to the USB [TO HOST] terminal of this instrument. This means that your keyboard performance, SONG/STYLE/PATTERN cannot be recorded to a computer or iPad/iPhone as audio data.

### Data that can be transferred from a computer to this instrument (and vice versa).

- Song: (.mid) SMF format 0/1
  - Style: (.sty)
  - Backup File: PSR-E443.BUP \*
- \* Backup parameters can be transferred and saved to a computer via Musicsoft Downloader as a single Backup file.

### NOTE

- This instrument can transfer/load up to a maximum of 256 Song files.

## Connecting an iPad/iPhone

By connecting your iPad/iPhone to the instrument, you can take advantage of various functions. To make connections, prepare the optional i-UX1, then refer to the “iPhone/iPad Connection Manual” (page 9) on the website.

# Backup and Initialization

## Backup Parameters

The following Backup parameters will be maintained even if the power is turned off.

### Backup parameters

- User Songs (page 30)
- Style data transferred from a computer and loaded to Style numbers 201–205 (page 61)
- Registration Memory (page 33)
- FUNCTION Settings: (page 52)
  - Tuning, Split Point, Touch Response, Style Volume, Song Volume, Pattern Volume, Metronome Volume, Grade, Demo Group, Demo Play Mode, Demo Cancel, Master EQ type, Your Tempo on/off, Auto Power Off setting, Battery Select, Language

In addition to the Backup parameters above, all the data (including Style data that have not been loaded) transferred from the connected computer will be maintained even if you turn off the power.

## Initialization

This function erases the Backup data described above, and then restores all the default factory settings. You can initialize your original data via the following two methods.

## Backup Clear

This operation initializes the backup parameters. While holding down the highest white key, press the [  ] (Standby/On) switch to turn the power on.

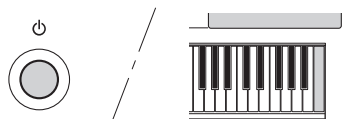

## Flash Clear

This operation deletes all the Songs and Styles that have been transferred from a computer. Note that Style data registered to Style numbers 201–205 will be maintained. While simultaneously holding the highest white key and the three highest black keys, press the [  ] (Standby/On) switch to turn the power on.

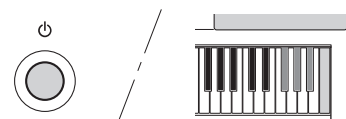

### NOTICE

- Keep in mind that this operation also deletes the data you have purchased. Be sure to save the important data to a computer via Musicsoft Downloader (MSD) software. For details, refer to “Computer-related Operations” (page 9).

# Handy Performance Features

## Selecting a Reverb Type

The Reverb effect lets you play with a rich concert hall type ambience.

Although selecting a Style or Song will call up the optimum Reverb type for the entire sound, you can select a different Reverb type manually.

- 1 Press the [FUNCTION] button.



- 2 Use the CATEGORY [+] and [-] buttons to call up “Reverb” (Function 035).

After “Reverb” is shown for a few seconds, the current Reverb Type is shown.

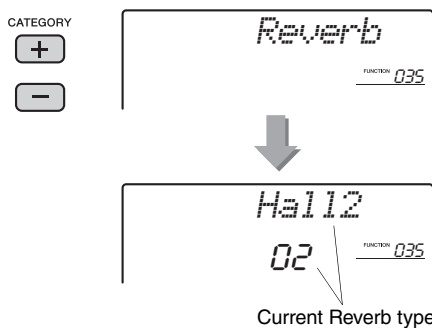

### NOTE

- Some Songs and Styles use Reverb Types which cannot be selected via panel operation. If such a Song or Style is played back, “- -” is shown on the display.

- 3 Rotate the dial to select a Reverb type.

Play the keyboard to check the sound. For information about the available Reverb types, refer to the Effect Type List in the Data List (page 9).

### Adjusting the Reverb depth

You can adjust the Reverb depth applied to the Main, Dual, and Split Voices individually via the same operations above. Regarding the item in Step 2, refer to the Function List on page 52.

## Selecting a Chorus Type

The Chorus effect creates a thick sound that is similar to many of the same Voices being played in unison.

Although selecting a Style or Song will call up the optimum Chorus type for the entire sound, you can select a different Chorus type manually.

- 1 Press the [FUNCTION] button.



- 2 Use the CATEGORY [+] and [-] buttons to call up “Chorus” (Function 036).

After “Chorus” is shown for a few seconds, the current Chorus Type is shown.

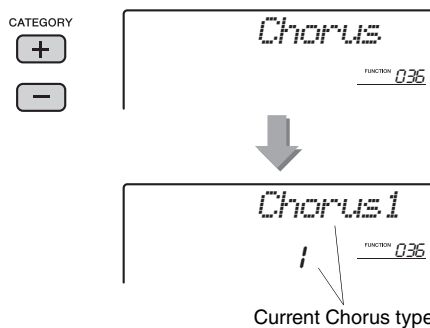

### NOTE

- Some Songs and Styles use Chorus Types which cannot be selected via panel operation. If such a Song or Style is played back, “- -” is shown on the display.

- 3 Rotate the dial to select a Chorus type.

Play the keyboard to check the sound. For information about the available Chorus types, refer to the Effect Type List in the Data List (page 9).

### Adjusting the Chorus depth

You can adjust the Chorus depth applied to the Main, Dual, and Split Voices individually via the same operations above. Regarding the item in Step 2, refer to the Function List on page 52.

## Pitch Controls—Transpose

The overall pitch of the instrument (except for the Drum Kit Voices) can be shifted up or down by a maximum of 1 octave in semitone increments.

- 1 Press the [TRANPOSE] button to call up “Transpose” (Function 005).

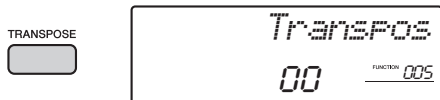

- 2 Use the dial to set the Transpose value between -12 and +12.

## Pitch Controls—Fine Tuning

The overall tuning of the instrument (except for the Drum Kit Voices) can be shifted up or down between 427.0 Hz and 453.0 Hz in approximately 0.2 Hz increments. The default value is 440.0 Hz.

- 1 Press the [FUNCTION] button.



- 2 Use the CATEGORY [+] and [-] buttons to call up “Tuning” (Function 006).

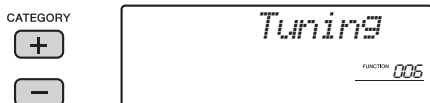

- 3 Use the dial to set the Tuning value.

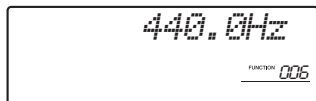

## Pitch Controls—the PITCH BEND wheel

The PITCH BEND wheel can be used to add smooth pitch variations to notes you play on the keyboard. Roll the wheel upward to raise the pitch, or downward to lower the pitch.

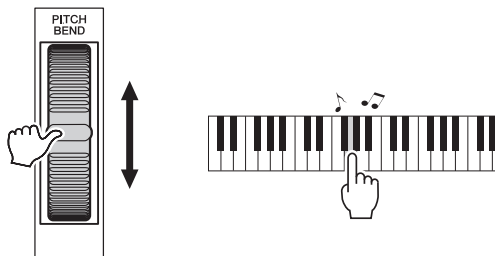

You can change the amount of pitch bend produced by the wheel. Refer to “Pitch Bend Range” in the Function List (page 52).

## Calling Up Optimum Panel Settings—One Touch Setting (OTS)

Select Voice number “000 OTS.” This lets you automatically call up the optimum Voice or Tempo for the current Song, Style or Pattern.



## Changing the Touch Response of the Keyboard

The keyboard of this instrument is equipped with a Touch Response feature that lets you dynamically and expressively control the level of the Voices according to your playing strength.

- 1 Press the [FUNCTION] button.



- 2 Press the CATEGORY [+] or [-] button several times until “TouchRes” (Function 009) appears.

“TouchRes” is shown in the display for a few seconds, and the current Touch Response is shown.

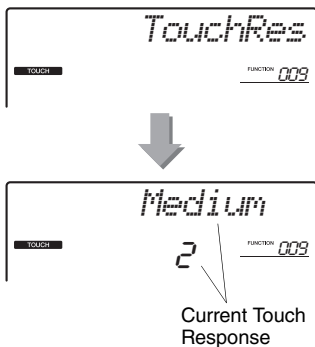

- 3 Use the dial to select a Touch Response setting between 1 and 4.

When “1”–“3” is selected, higher values produce greater (easier) volume variation in response to keyboard dynamics—i.e. greater sensitivity. When “4” (Fixed) is selected, all notes will be played at the same volume no matter how strongly or softly you play the keys.

**NOTE 1**

• The initial default Touch Response value is “2.”

## Selecting an EQ Setting for the Best Sound

Six different master equalizer (EQ) settings give you the best possible sound when listening through different reproduction systems—the instrument’s internal speakers, headphones, or an external speaker system.

- 1 Hold down the [MELODY SUPPRESSOR] button for longer than a second to call up “Master EQ” (Function 037).

“MasterEQ” is shown in the display for a few seconds, and the current Master EQ type appears.

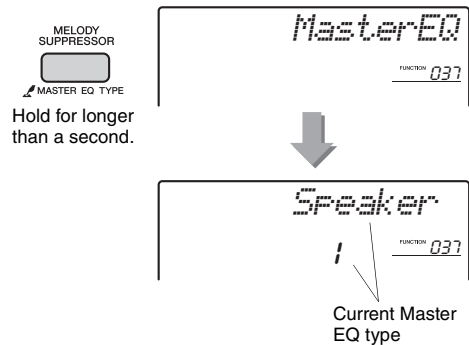

- 2 Rotate the dial to select the desired Master EQ type.

**Master EQ types**

1	Speaker	Optimum for listening via the instrument’s built-in speakers.
2	Headphone	Optimum for headphones, or for listening via external speakers.
3	Boost	Features more powerful sound.
4	Piano	Optimum for piano solo performance.
5	Bright	Lowers the mid range for a brighter sound.
6	Mild	Lowers the high range for a softer sound.

# Scale Tuning

By default, this keyboard scale is set to Equal Temperament — the same tuning as with any acoustic piano. However, the setting can be changed to any other scale according to the music genre or music style you want to play.

## Selecting Scale

You can select a desired scale among the various pre-set scales.

- 1 Press the [FUNCTION] button.



- 2 Use the CATEGORY [+] or [-] button to call up “Scale” (Function 045).

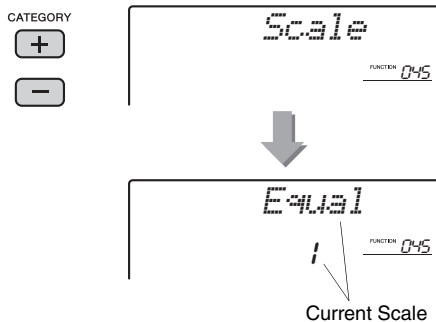

- 3 Rotate the dial to select a scale.

The default setting is “1 Equal.”

### Preset Scale types

1	Equal
2	Pure Major
3	Pure Minor
4	Bayat (Arabic)
5	Rast (Arabic)

## Setting the Base Note for Each Scale

Please make sure to specify the appropriate Base Note, if you select a scale other than Equal Temperament, or create an original scale via Scale Tune function.

- 1 Press the [FUNCTION] button.



- 2 Use the CATEGORY [+] or [-] button to call up “BaseNote” (Function 046).

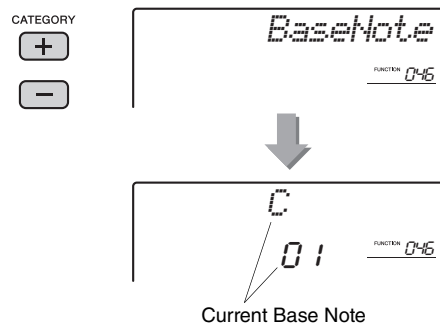

- 3 Rotate the dial to select a Base Note from C, C#, D, E $\flat$ , E, F, F#, G, A $\flat$ , A, B $\flat$  and B.

The default setting is “C.”

## Tuning Each Note to Create an Original Scale

You can tune the individual notes in cents (a “cent” is one one-hundredth of a semitone.) to create your original scale.

- 1 **Select the Base Note following the “Setting the Base Note for Each Scale” instructions (page 38).**
- 2 **Use the CATEGORY [+] or [-] button to call up the individual notes to be tuned, such as “Tune C” (Function 047) as shown.**

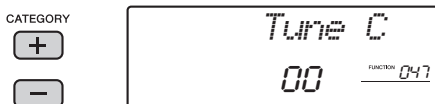

You can choose the note to be tuned from among the 12 notes below.

“C”(Function 047), “C#”(048), “D”(049),  
 “E♭”(050), “E”(051), “F”(052), “F#”(053),  
 “G”(054), “A♭”(055), “A”(056), “B♭”(057),  
 “B”(058)

- 3 **Rotate the dial to tune the note selected in step 2.**  
 The tuning range is from -64 to +63.  
 The setting can be reset to the initial default value by pressing the [+ / YES] and [- / NO] buttons simultaneously.
- 4 **Repeat steps 2–3 as desired.**
- 5 **Memorize the settings here to the Registration Memory as desired (page 33).**

### NOTE

- When pressing the [+ / YES] and [- / NO] buttons simultaneously after recalling an original scale memorized to Registration Memory, the scale will return to the original scale registered to Registration Memory, not to the default tune value.
- When calling up “Scale (Function 045)” after using individual note scale tuning, “(Edited)” will be shown in the display. However, the edited scale settings will be erased by calling up another scale. For this reason, the edited settings should be memorized to the Registration Memory.

# Voice Settings

## Selecting a Dual Voice

- 1 Hold down the [DUAL] button for longer than a second to call up “D.Voice.”

“D.VOICE” is shown for a few seconds, then the current Dual Voice appears.

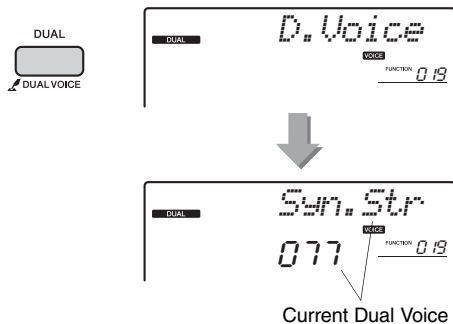

- 2 Rotate the dial to select the desired Dual Voice.

## Selecting a Split Voice

- 1 Hold down the [SPLIT] button for longer than a second to call up “S.Voice.”

“S.VOICE” is shown for a few seconds, then the current Split Voice appears.

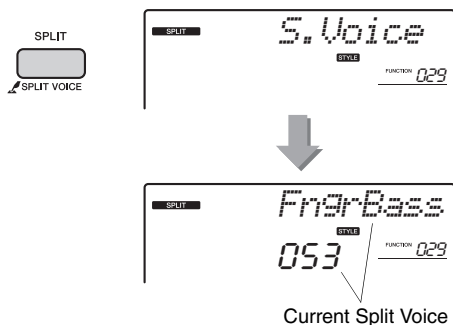

- 2 Rotate the dial to select the desired Split Voice.

## Voice Editing

For each of the Main, Dual and Split Voices, you can edit the parameters such as volume, octave and depth of the Reverb and Chorus, allowing you to create new, custom sounds that best suit your musical needs.

- 1 Press the [FUNCTION] button.



- 2 Use the CATEGORY [+] and [-] buttons to call up the desired item.

Voice parameters are indicated as below.

- Main Voice parameters: M.\*\*\*\*\* (Function 010–018)
- Dual Voice parameters: D.\*\*\*\*\* (Function 019–028)
- Split Voice parameters: S.\*\*\*\*\* (Function 029–034)

For information about each parameter, refer to the Function List on page 53.

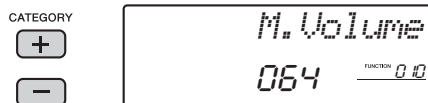

- 3 Rotate the dial to set the value.

Check the sound by playing the keyboard.

- 4 Repeat Steps 2–3 above to edit various parameters.

- 5 If necessary, memorize the settings to the Registration Memory (page 33).

The Voice-related settings are reset when a different Voice is selected. If you want to store the created sound for future recall, memorize the settings to the Registration Memory.

# Parameters Assigned to the Knobs

This section describes each of the parameters which can be assigned to the Knobs (page 22).

## 1 FILTER

Filter effects shape the sound by allowing only a specified range of frequencies to pass and/or by producing a resonance peak at the filter's "cutoff" frequency. Filter effects can be used to create a range of synthesizer-like sounds.

### NOTE

- These effects are applied only to the Main/Dual Voices played on the keyboard.
- Filter effects can sometimes cause distortion in the bass frequencies.

### ● Knob A: CUTOFF

Adjusts the filter's cutoff frequency, and therefore the brightness of the sound. Turning the Knob to the left makes the sound more muffled or darker, while turning the Knob A to the right makes the sound brighter.

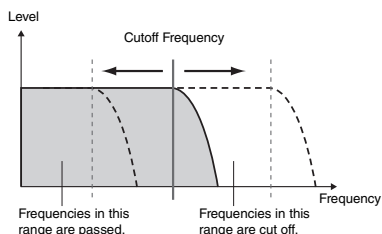

### ● Knob B: RESONANCE

Adjusts the amount of Resonance applied at the filter's cutoff frequency. Turning the Knob to the right will increase the Resonance to emphasize the frequencies at the cutoff frequency, and thus "strengthen" the perceived effect of the filter.

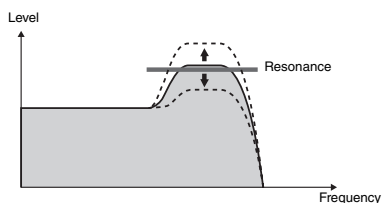

## 2 EFFECT

### ● Knob A: REVERB

Reproduces the acoustic ambience of a concert hall or club. Turning the Knob to the right will increase the Reverb depth.

### ● Knob B: CHORUS

Produces a layered "multi-instrument" effect. Turning the Knob to the right will increase the Chorus depth.

### NOTE

- These effects are applied only to the Main/Dual Voices played on the keyboard.

## 3 EG (Envelope Generator)

Envelope Generator effects determine how the level of the sound varies over time. You can make the attack faster for a more percussive sound or slower for a violin-like sound, for example. Or you can lengthen or shorten the sustain to best match the music you're playing.

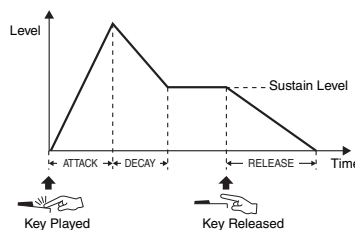

### ● Knob A: ATTACK

Adjusts the Attack Time (the amount of time it takes the sound to reach maximum level when a key is played). Turning the Knob to the right will increase the Attack Time, thus slowing down the attack rate.

### ● Knob B: RELEASE

Adjusts the Release Time (the amount of time it takes for the sound to decay to silence after a key is released). Turning the Knob to the right will increase the Release Time, thus make a longer sustain.

### NOTE

- These effects are applied only to the Main/Dual Voices played on the keyboard.

## 4 STYLE FILTER

Same as "1 FILTER." These effects are applied only to Style or Pattern playback.

## 5 AUX IN

These knobs can be used when playing an external audio device connected to the [AUX IN] jack of this instrument.

### ● Knob A: SUPPRESSOR PAN

Turn on the Melody Suppressor, then rotate this knob to move the pan position to be cancelled.

### ● Knob B: BALANCE

Adjusts the volume balance between the audio device and this instrument. Turning the knob left will decrease the volume of the audio device and increase the volume of this instrument, and vice versa. Even if an external audio device is not connected, rotating this

knob will increase/decrease the volume of the Song/Style/Pattern playback sound, maintaining the keyboard performance volume.

**6 SPECIAL EFFECT**

**● Knob A: ULTRA WIDE STEREO**

Lets you play the keyboard with a spacious, dynamic sound effect that gives you the sensation of hearing the sound outside of the speakers. By changing the wide effect type in the Function settings (page 53, Function 038), you can enhance the stereo image in different ways.

**● Knob B: RETRIGGER RATE**

While holding down the button of the currently playing Section, rotating this knob will change the Retrigger Rate (the length of the part to be repeated). Turning right will shorten the length, and vice versa.

The chart below lists some interesting ways to use the various effects that can be assigned to the knobs.

**Some Ideas for Using the Knobs**

Number/Effect		Try This	
<b>1</b>	FILTER	Select “140 Gemini” (a synth-lead type Voice) or “167 Noise.” (Refer to the Voice List of the separate Data List). Turning Knobs A or B while playing gives you the dynamic filter-sweep effects of an analog synthesizer.	
<b>2</b>	EFFECT	Select the Voice “008 CP80.” Turn Knobs A and B all the way down to hear the direct, unprocessed sound of the Voice. As you turn Knob B toward the right, a Chorus effect with modulation is gradually applied to the sound. Turning Knob A to the right adds a Reverb effect that makes you sound like you are playing in a concert hall.	
<b>3</b>	EG	Select the Voice “170 RsAnPad.” Turning Knob A all the way down makes the attack faster, and lets you hear the crisp, clear sound of the original Voice. Turning Knob B all the way down shortens the amount of time for the sound to decay to silence after a key is released. These knobs let you finely adjust the Voice to create the appropriate sound for the particular song you’re playing.	
<b>4</b>	STYLE FILTER	Select the Style, “049 EuTrance”. Turn accompaniment on and start Style playback (page 23). Set Knob B to about 3 o’clock, and Knob A to about 8 o’clock. The overall sound of the style should be a bit muffled, with the drums emphasized for solid rhythmic impact.	
<b>5</b>	AUX IN	Knob A: SUPPRESSOR PAN	Turn these knobs when playing back an external audio device such as iPhone, iPod etc. by connecting it to the [AUX IN] jack of this instrument (page 29). Turn Melody Suppressor on, then turn Knob A to adjust the pan position of the melody sound of an external audio device to be cancelled (lowered). When you can cancel (lower) the melody part, try playing the part yourself. Turning Knob B adjusts the volume balance between an external audio device and this instrument.
		Knob B: BALANCE	
<b>6</b>	SPECIAL EFFECT	Knob A: ULTRA-WIDE STEREO	This lets you create various sounds from simulated mono to wider stereo, even when playing only a single Voice (Grand Piano, Octave Strings, etc.).
		Knob B: RETRIGGER RATE	Select the Section C of the Pattern “001 FrenchDJ” and start Pattern playback. Turn this knob to the right while holding down the Section button C, and you can shorter the Retrigger rate like a DJ plays.

# Arpeggio Settings

## Synchronizing an Arpeggio to Song/Style/Pattern Playback—Arpeggio Quantize

When you play the keyboard to trigger an Arpeggio (page 21) along with Song/Style/Pattern playback, you'll need to play the notes with correct timing to keep the Arpeggio in synchronization with the other playback tracks. However, your actual timing may be slightly ahead of or behind the beat (or both). The "Arpeggio Quantize" function of this instrument will correct any slight imperfections in the timing (according to settings below), and then play back the Arpeggio appropriately.

- Synchronizing at the quarter notes
- Synchronizing at the 8th notes
- No synchronization

Although the Arpeggio Quantize value is pre-programmed for each Arpeggio Type, you can change the value manually.

### 1 Press the [FUNCTION] button.



### 2 Use the CATEGORY [+] and [-] buttons to call up "Quantize" (Function 043).

After "Quantize" is shown for a few seconds, the current Arpeggio Quantize value is shown.

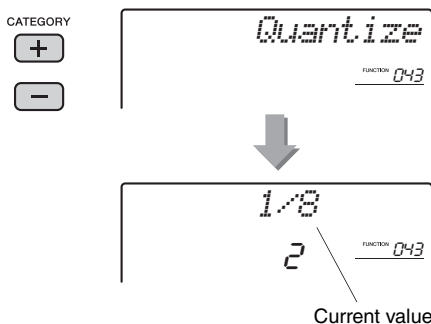

### 3 Rotate the dial to select a value from "OFF," "1/8" and "1/16."

- 1/8 Synchronizing at the quarter notes
- 1/16 Synchronizing at the 8th notes
- OFF No synchronization

## Holding the Arpeggio Playback via the Footswitch

You can set the instrument so that Arpeggio playback continues even after the note has been released, by pressing the footswitch connected to the [SUSTAIN] jack.

### 1 Press the [FUNCTION] button.



### 2 Use the CATEGORY [+] and [-] buttons to call up "Pd1 Func" (Function 044).

After "Pd1 Func" is shown for a few seconds, the current setting is shown.

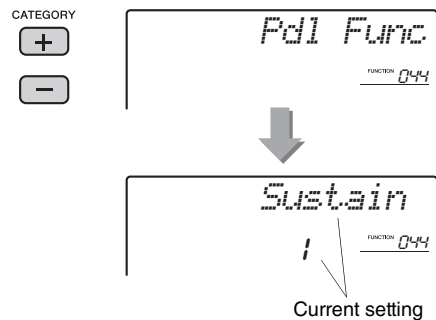

### 3 Rotate the dial to select "Arp Hold."

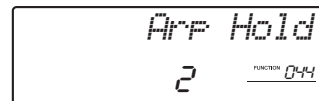

If you want to restore the footswitch function to sustain, select "Sustain." If you want to use both hold and sustain functions, select "Hold+Sus."

### 4 Try playing Arpeggio with the footswitch.

Press the notes to trigger the Arpeggio, then press the footswitch. Even if you release the notes, Arpeggio playback will continue. To stop Arpeggio playback, release the footswitch.

# Styles (Auto Accompaniment) and Patterns

## Style Variations—Sections

Each Style consists of “Sections” that allow you to vary the arrangement of the accompaniment to match the song you are playing.

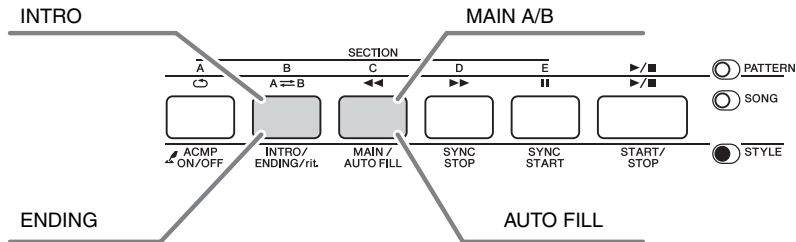

### INTRO

This is used for the beginning of the Song. When the Intro finishes, Style playback shifts to the Main section. The length of the Intro (in measures) differs depending on the selected Style.

### MAIN

This is used for playing the main part of the Song. Playback of the Main section repeats indefinitely until another Section’s button is pressed. There are two variations (A and B), and the Style playback sound changes harmonically in response on the chords you play with your left hand.

### AUTO FILL

This is automatically added before changing to Main A or B.

### ENDING

This is used for the ending of the Song. When the Ending finishes, the Style playback stops automatically. The length of the Ending (in measures) differs depending on the selected Style.

- 1 Press the [STYLE] button, then rotate the dial to select a Style.
- 2 Press the [ACMP ON/OFF] button to turn ACMP on.

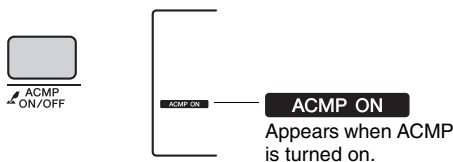

- 3 Press the [SYNC START] button to turn Synchro Start on.



#### ● Synchro Start

When the Synchro Start is on, Style playback will begin as soon as you play a chord in the accompaniment range of the keyboard. To turn off the Synchro Start, press the [SYNC START] button.

- 4 Press the [MAIN/AUTO FILL] button to select Main A or Main B.

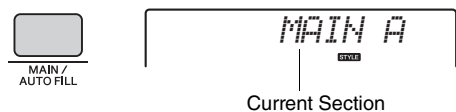



**5 Press the [INTRO/ENDING/rit.] button.**



Now, you're ready to start Style playback from the Intro section.

**6 Play a chord with your left hand to start playback of the Intro.**

For this example, play a C major chord (as shown below). For information on how to enter chords, see "Chords" on page 48.

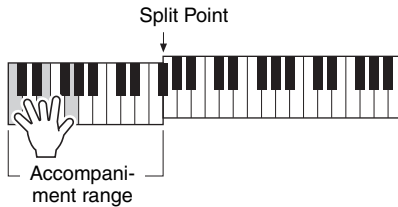

**7 After the Intro finishes, play the keyboard according to the progression of the Song you are playing.**

Play chords with your left hand while playing melodies with your right hand, and press the [MAIN/AUTO FILL] button as necessary. The Section will change to Fill-in then Main A or B.

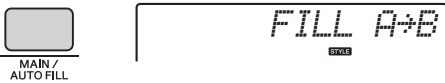

**8 Press the [INTRO/ENDING/rit.] button.**

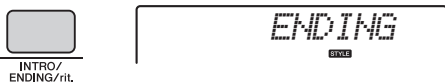

The Section switches to the Ending. When the Ending is finished, Style playback stops automatically. You can have the Ending gradually slow down (ritardando) by pressing the [INTRO/ENDING/rit.] button again while the Ending is playing back.

**Synchro Stop**

When you press the [SYNC/STOP] button to turn on this function, the Style will only play while pressing chords in the Accompaniment range of the keyboard. Releasing all the notes will stop Style playback. This makes it easy to add rhythmic breaks as you perform, simply by releasing your hand from the Accompaniment range of the keyboard.

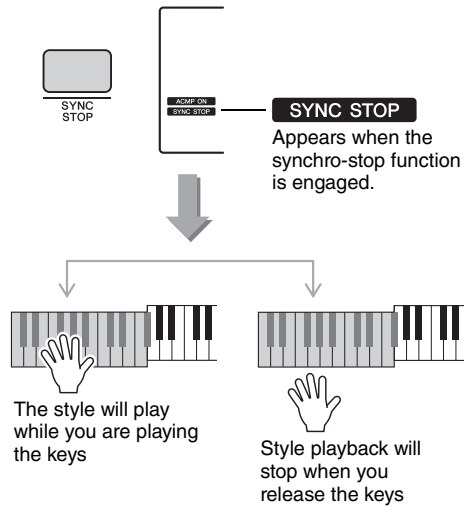

**Turning Each Track Of Style On/Off**

As printed on the front panel, a Style consists of six tracks. Turn on/off each track via the [TRACK CONTROL] button. Each of the tracks can be muted so that you can play the muted part yourself. Pressing the desired Track button repeatedly will toggle the on/off status.

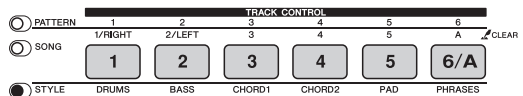

1 2 3 4 5 6 — On/off status is shown in the display (page 16)

**NOTE**

- Up to two Track buttons can be pressed simultaneously for turning Tracks on or off.

## Pattern Variations—Sections

Like the Styles, each Pattern features several Sections, allowing you to add dynamic variations to the performance. Five Sections (A–E) are provided.

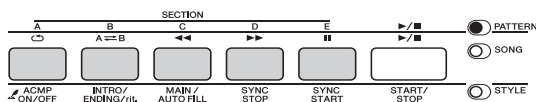

Unlike the Styles, however, Patterns do not have the Sections dedicated to the beginning or ending of the Song, such as Intro and Ending. All Sections A–E will play back repeatedly until stopped manually.

## Pattern Retrigger Function

This function restarts Pattern playback from the beginning.

- 1 Press the [PATTERN] button, then rotate the dial to select the desired Pattern.



- 2 Press the [START/STOP] button or press any key to the left of the Split Point (page 47) to start Pattern playback.
- 3 By pressing the button of the currently playing Section, you can restart playback from the beginning. Holding down the button lets loop-play only the top portion of the Section.

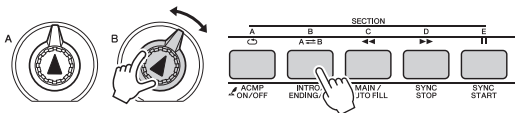

The top portion length (Retrigger rate) can be changed during playback. To do this, use the [ASSIGN] button to select “6 SPECIAL EFFECT,” then rotate Knob B while holding down the button of the currently playing Section.

### NOTE

- When recording the Pattern playback with the Retrigger, note that the beat indicator in the display, metronome and Arpeggio playback is not synchronized with playback of the recorded Song.
- When setting the tempo of the Pattern playback to more than 200, turning the Knob to the right cannot change the length from the 1st beat of 1st measure.

## Changing the Tempo

A Style or Pattern can be played at any tempo you desire—fast or slow.

- 1 Press the [TEMPO/TAP] button to call up the Tempo value in the display.

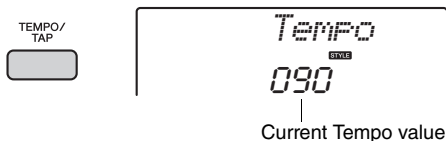

- 2 Rotate the dial to set a tempo from 011 to 280.

Press the [+ / YES] and [- / NO] buttons simultaneously to instantly reset the value to the default tempo of the current Style or Pattern. You can change the tempo during playback by pressing the [TEMPO/TAP] button just twice at the required tempo.

### NOTE

- The above operation applies also to Song or Arpeggio playback tempo.

## Tap Start

You can start play back of the Style, Pattern or Song by simply tapping the [TEMPO/TAP] button at the required tempo—four times for time signatures in 4 (4/4, etc.), and three times for time signatures in 3 (3/4, etc.).



### NOTE

- Tap tempo setting range: 32–280

## Adjusting the Volume of the Style or Pattern

You can adjust the volume balance between Style or Pattern playback and keyboard performance.

### 1 Press the [FUNCTION] button.



### 2 Use the CATEGORY [+] and [-] buttons to call up “StyleVol” (Function 001) or “PatrnVol” (Function 003).



### 3 Rotate the dial to set the volume between 000 and 127.

## Setting the Split Point

The point on the keyboard that separates the left-hand range and the right-hand range of the keyboard is called the “Split Point.”

The initial default Split Point is key number 054 (the F#2 key), but you can change it to another key.

### 1 Press the [FUNCTION] button.



### 2 Use the CATEGORY [+] and [-] buttons to call up “SplitPnt” (Function 008).

You can call up this display also by pressing the [STYLE] then holding the [ACMP] button for longer than a second.

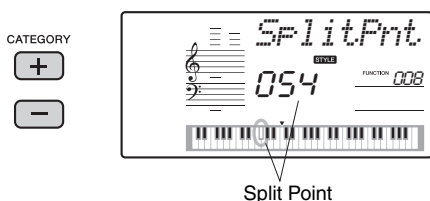

### 3 Rotate the dial to set the Split Point between 036 (C1) and 096 (C6).

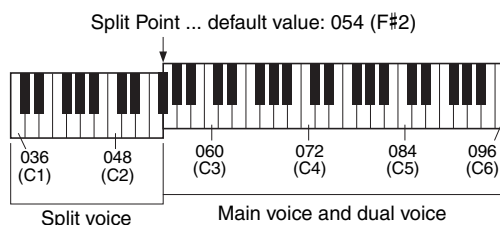

#### NOTE

- When a Style is selected and ACMP is on, the notes played to the left of the Split Point are used to specify the chord for Style playback. When a Pattern is selected, the note played to the left of the Split Point is used to specify the key for Pattern playback.
- The Split Point set here is applied common to the Style, Pattern and Voice.
- During the Lesson playback, the Split Point cannot be changed.

## Playing Chords Without Style Playback



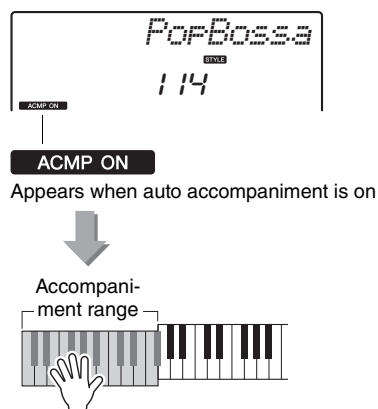































If you press the [STYLE] button, press the [ACMP ON/OFF] button to turn ACMP on (the ACMP ON icon appears), and play the chord in the Left hand range of the keyboard (with SYNC START off), the chord sound will be heard without Style playback. This is referred to as “Stop Accompaniment.” The specified chord will be shown in the display, and affects the Harmony function (page 20).



## Chord Types for Style Playback

For users who are new to chords, this chart features common chords. Since there are many useful chords and many different ways to use them musically, refer to commercially available chord books for further details.

★ indicates the root note.

Major	Minor	Seventh	Minor Seventh	Major Seventh
<b>C</b> 	<b>Cm</b> 	<b>C7</b> 	<b>Cm7</b> 	<b>CM7</b> 
<b>D</b> 	<b>Dm</b> 	<b>D7</b> 	<b>Dm7</b> 	<b>DM7</b> 
<b>E</b> 	<b>Em</b> 	<b>E7</b> 	<b>Em7</b> 	<b>EM7</b> 
<b>F</b> 	<b>Fm</b> 	<b>F7</b> 	<b>Fm7</b> 	<b>FM7</b> 
<b>G</b> 	<b>Gm</b> 	<b>G7</b> 	<b>Gm7</b> 	<b>GM7</b> 
<b>A</b> 	<b>Am</b> 	<b>A7</b> 	<b>Am7</b> 	<b>AM7</b> 
<b>B</b> 	<b>Bm</b> 	<b>B7</b> 	<b>Bm7</b> 	<b>BM7</b> 

- Inversions can be used as well as in "root" position — with the following exceptions: m7, m7<sup>b</sup>5, 6, m6, sus4, aug, dim7, 7<sup>b</sup>5, 6(9), sus2
- Inversion of the 7sus4 and m7(11) chords are not recognized if the notes are omitted.
- When playing a chord which cannot be recognized by this instrument, nothing is shown on the display. In such a case, only the rhythm and bass parts will be played.

### Easy Chords

This method lets you easily play chords in the accompaniment range of the keyboard using only one, two, or three fingers.

For root "C"



**To play a major chord**  
Press the root note (★) of the chord.



**To play a minor chord**  
Press the root note together with the nearest black key to the left of it.



**To play a seventh chord**  
Press the root note together with the nearest white key to the left of it.



**To play a minor seventh chord**  
Press the root note together with the nearest white and black keys to the left of it (three keys altogether).

## Looking Up Chords Using the Chord Dictionary

The Dictionary function is useful when you know the name of a certain chord and want to quickly learn how to play it.

### 1 Press and hold the [CHORD DICT] button for longer than a second to call up “Dict.”



Hold for longer than a second.

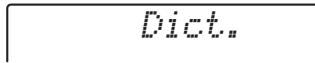

This operation will divide the entire keyboard into the three ranges as illustrated below.

- The range to the right of “ROOT ▶”:  
Lets you specify the Chord Root, but produces no sound.
- The range between “CHORD TYPE ▶” and “ROOT ▶”:  
Lets you specify the Chord Type, but produces no sound.
- The range to the left of “CHORD TYPE ▶”:  
Lets you play and confirm the Chord specified in the above two ranges.

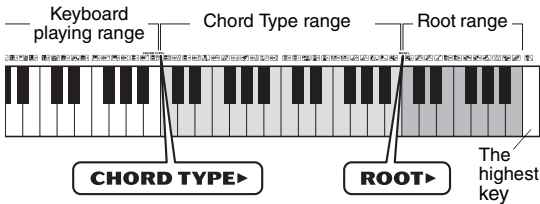

### 2 As an example, learn how to play a GM7 (G major seventh) chord.

2-1. Press the “G” key in the section to the right of “ROOT ▶” so that the “G” is shown as the root note.

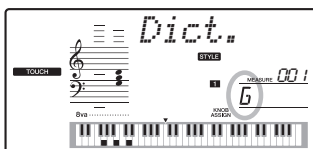
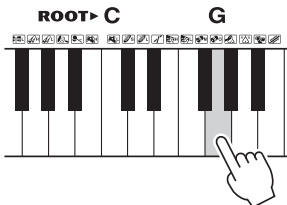

2-2. Press the key labeled “M7” in the section between “CHORD TYPE ▶” and “ROOT.” The notes you should play for the specified chord (root note and chord type) are conveniently shown in the display, both as notation and in the keyboard diagram.

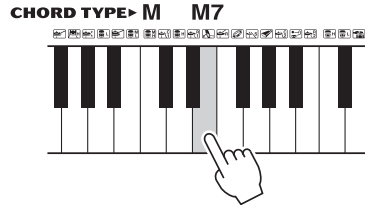

Notation of chord      Chord name (root and type)

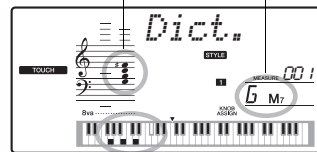

Individual notes of chord (keyboard)

To call up possible inversions of the chord, press the [+ / YES] [ - / NO ] buttons.

**NOTE**

- About major chords: Simple major chords are usually indicated only by the root note. For example, “C” refers to C major. However, when specifying major chords here, make sure to select “M” (major) after pressing the root note.

### 3 Following the notation and keyboard diagram in the display, try playing a chord in the range to the left of “CHORD TYPE ▶.”

When you’ve played the chord properly, a bell sound signals your success and the chord name in the display flashes.

#### Specifying only the key for Pattern playback

Note that you need to specify only the root note for Pattern playback, unlike Style playback for which you also need to specify the Chord Type.

# Song Settings

## BGM (Background Music) Playback

With the default setting, pressing the [DEMO/BGM] button will play back only a few of the internal Songs repeatedly. This setting can be changed so that, for example, all internal Songs are played, or all Songs transferred to the instrument from a computer are played back, letting you use the instrument as a background music source. Five playback group settings are provided. Simply select the one that suits your needs.

### 1 Hold down the [DEMO/BGM] button for longer than a second.

“DemoGrp” is shown in the display for a few seconds, followed by the current repeat playback target.

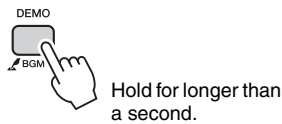

### 2 Rotate the dial to select a repeat playback group from the table below.

Demo	Preset Songs 001–003
Preset	All preset Songs
User	All User Songs
Download	All Songs transferred from a computer
USB	All Songs (MIDI files) in the connected USB flash memory

#### NOTE 1

- When User Songs, Download Songs and USB Songs data do not exist, Demo songs are played back.

### 3 Press the [DEMO] button to start playback.

To stop playback, press the [DEMO] button again.

## Random Song Playback

The order of Song repeat playback via the [DEMO/BGM] button can be changed between the numerical order and random order.

### 1 Press the [FUNCTION] button.



### 2 Press the CATEGORY [+] and [-] buttons several times to call up “PlayMode” (Function 074).

“PlayMode” is shown for a few seconds, followed by the current playback mode, “Normal” or “Random.”

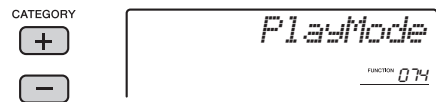

When the DemoGrp is set to “Demo,” this parameter cannot be set.

### 3 Rotate the dial to select “Random.”

To return to the numerical order, select “Normal.”

### 4 Press the [DEMO] button to start playback.

To stop playback, press the [DEMO] button again.

## Tempo Setting of the Song

This operation is same as that of the Style and Pattern.  
Refer to page 46.

## Tap Start

This operation is same as that of the Style and Pattern.  
Refer to page 46.

## Song Volume

- 1 Press the [FUNCTION] button.



- 2 Press the CATEGORY [+] and [-] buttons several times to call up “SongVol” (Function 002).

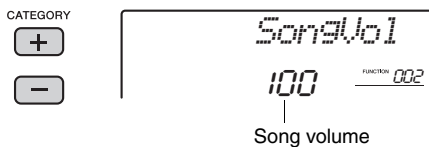

- 3 Rotate the dial to set the Song volume between 000 and 127.

**NOTE**

- Song volume can be adjusted while a Song is selected.

## Melody Voice Setting of the Pre-set Song

You can change the Melody Voice of the current Pre-set Song temporarily to any other desired Voice.

- 1 Press the [SONG] button, select the desired Pre-set Song, then start playback.



- 2 Press the [VOICE] button, then rotate the dial to select the desired Voice.

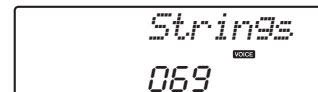

- 3 Hold down the [VOICE] button for longer than a second.

After “SONG MELODY VOICE” is shown for a few seconds, the Melody Voice of the Song will be changed to that selected in Step 2.

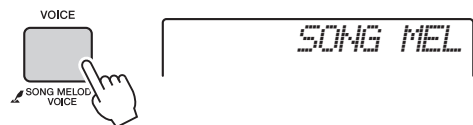

Hold for longer than a second.

**NOTE**

- Selecting another Song will cancel the changed Melody Voice.
- You cannot change the Melody Voice of a User Song.

# The Functions

The “Functions” provide access to a range of detailed instrument parameters such as Tuning, Split Point, Voices and Effects. Take a look at the Function List (pages 52–55). When you find the desired Function you want to change, follow the instructions below.

## Basic Procedure in the Function Display

1 Find the desired item in the Function List on pages 52–55.

2 Press the [FUNCTION] button.

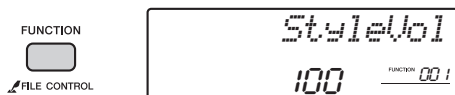

3 Press the CATEGORY [+] and [-] buttons several times until the desired item appears.

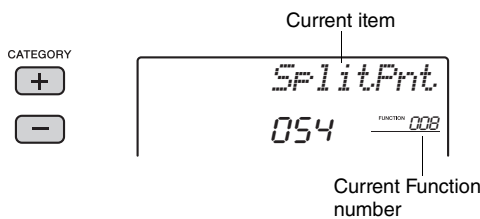

4 Use the dial, the [+ / YES] and [- / NO] buttons, or the [0]–[9] number buttons to set the value of the selected function.

To restore the default value, press the [+ / YES] and [- / NO] buttons simultaneously. In the sole case of the MIDI Initial Send function (page 54), pressing the [+ / YES] button executes the function while pressing [- / NO] cancels it.

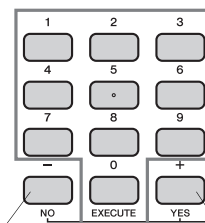
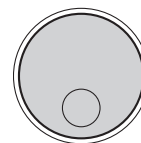

Direct numeric entry.

- Decrement value by 1.
- Cancel
- Press simultaneously to recall the default setting.
- Increment value by 1.
- Execute

Some Function settings are maintained even if you turn off the power, and can be transferred to the computer as Backup Data (page 34).

## Function List

Function Number	Function	Display	Range/Settings	Default Value	Description
<b>Volume</b>					
001	Style Volume	<i>StyleVol</i>	000–127	100	Refer to page 47.
002	Song Volume	<i>SongVol</i>	000–127	100	Refer to page 51.
003	Pattern Volume	<i>PatrnVol</i>	000–127	100	Refer to page 47.
004	Aux In Volume	<i>AuxInVol</i>	000–127	100	Refer to page 29.
<b>Overall</b>					
005	Transpose	<i>Transpos</i>	-12–12	00	Refer to page 36.
006	Tuning	<i>Tuning</i>	427.0Hz–453.0Hz (in approximately 0.2Hz increments)	440.0Hz	Refer to page 36.
007	Pitch Bend Range	<i>PBRange</i>	01–12	02	Sets the range over which you can control pitch by using the PITCH BEND wheel (page 36), in semitone increments.
008	Split Point	<i>SplitPnt</i>	036–096 (C1–C6)	054 (F#2)	Refer to page 47.
009	Touch Response	<i>TouchRes</i>	1 (Soft), 2 (Medium), 3 (Hard), 4 (Fixed)	2 (Medium)	Refer to page 37.



Function Number	Function	Display	Range/Settings	Default Value	Description
<b>Main Voice (page 17)</b>					
010	Volume	<i>M. Volume</i>	000–127	*	Determines the volume of the Main Voice.
011	Octave	<i>M. Octave</i>	-2 – +2	*	Determines the octave range for the Main Voice.
012	Pan	<i>M. Pan</i>	000 (left)– 064 (center)– 127 (right)	*	Determines the stereo pan position of the Main Voice. The value “0” results in the sound being panned full left; the value “127” results in the sound being panned full right.
013	Reverb Depth	<i>M. Reverb</i>	000–127	*	Determines how much of the Main Voice’s signal is sent to the Reverb effect.
014	Chorus Depth	<i>M. Chorus</i>	000–127	*	Determines how much of the Main Voice’s signal is sent to the Chorus effect.
015	Attack Time	<i>M. Attack</i>	000–127	064	Determines how fast the volume of the Main Voice reaches the Attack level when the note is pressed. The larger the value, the slower the attack rate. The smaller the value, the faster the attack rate.
016	Release Time	<i>M. Releas</i>	000–127	064	Determines how fast the volume of the Main Voice falls to 0 when the note is released. The larger the value, the longer the sustain. The smaller the value, the shorter the sustain.
017	Filter Cutoff	<i>M. Cutoff</i>	000–127	064	Determines the Filter Cutoff Frequency (page 41) of the Main Voice.
018	Filter Resonance	<i>M. Reso.</i>	000–127	064	Determines the Filter Resonance (page 41) of the Main Voice.
<b>Dual Voice (page 18)</b>					
019	Dual Voice	<i>D. Voice</i>	001–755	*	Selects a Dual Voice.
020	Volume	<i>D. Volume</i>	000–127	*	Determines the volume of the Dual Voice.
021	Octave	<i>D. Octave</i>	-2 – +2	*	Determines the octave range for the Dual Voice.
022	Pan	<i>D. Pan</i>	000 (left)– 064 (center)– 127 (right)	*	Determines the stereo pan position of the Dual Voice. A value of “0” results in the sound being panned full left; a value of “127” results in the sound being panned full right.
023	Reverb Depth	<i>D. Reverb</i>	000–127	*	Determines how much of the Dual Voice’s signal is sent to the Reverb effect.
024	Chorus Depth	<i>D. Chorus</i>	000–127	*	Determines how much of the Dual Voice’s signal is sent to the Chorus effect.
025	Attack Time	<i>D. Attack</i>	000–127	064	Determines how fast the volume of the Dual Voice reaches the Attack level when the note is pressed. The larger the value, the slower the attack rate. The smaller the value, the faster the attack rate.
026	Release Time	<i>D. Releas</i>	000–127	064	Determines how fast the volume of the Dual Voice falls to 0 when the note is released. The larger the value, the longer the sustain. The smaller the value, the shorter the sustain.
027	Filter Cutoff	<i>D. Cutoff</i>	000–127	064	Determines the Filter Cutoff Frequency (page 41) of the Dual Voice.
028	Filter Resonance	<i>D. Reso.</i>	000–127	064	Determines the Filter Resonance (page 41) of the Dual Voice.
<b>Split Voice (page 18)</b>					
029	Split Voice	<i>S. Voice</i>	001–755	053 (FngrBass)	Selects a Split Voice.
030	Volume	<i>S. Volume</i>	000–127	080	Determines the volume of the Split Voice.
031	Octave	<i>S. Octave</i>	-2 – +2	-1	Determines the octave range for the Split Voice.
032	Pan	<i>S. Pan</i>	000 (left)– 064 (center)– 127 (right)	064	Determines the stereo pan position of the Split Voice. A value of “0” results in the sound being panned full left; a value of “127” results in the sound being panned full right.
033	Reverb Depth	<i>S. Reverb</i>	000–127	008	Determines how much of the Split Voice’s signal is sent to the Reverb effect.
034	Chorus Depth	<i>S. Chorus</i>	000–127	000	Determines how much of the Split Voice’s signal is sent to the Chorus effect.
<b>Effects</b>					
035	Reverb Type	<i>Reverb</i>	01–10	**	Refer to page 35.
036	Chorus Type	<i>Chorus</i>	1–6	**	Refer to page 35.
037	Master EQ Type	<i>MasterEQ</i>	1 (Speaker), 2 (Headphone), 3 (Boost), 4 (Piano), 5 (Bright), 6 (Mild)	1 (Speaker)	Refer to page 37.
038	Wide Type	<i>Wide</i>	1–3	2 (Wide2)	Determines the Ultra-Wide Stereo type. Higher values produce a greater Wide effect.
<b>Harmony (page 20)</b>					
039	Harmony Type	<i>HarmType</i>	01–26	*	Determines the Harmony type.
040	Harmony Volume	<i>HarmVol</i>	000–127	*	Determines the volume of the Harmony effect.

Function Number	Function	Display	Range/Settings	Default Value	Description
<b>Arpeggio (page 21)</b>					
041	Arpeggio Type	<i>ARP Type</i>	001–150	*	Determines the Arpeggio type.
042	Arpeggio Velocity	<i>ARP Velo</i>	1(Original), 2(Thru)	Depending on the Arpeggio type	When “Thru” is selected, the velocities of Arpeggio playback are determined by your playing strength. When “Original” is selected, the velocities of Arpeggio playback are determined by the original setting regardless of your playing strength.
043	Arpeggio Quantize	<i>Quantize</i>	1(OFF), 2(1/8), 3(1/16)	Depending on the Arpeggio type	Refer to page 43.
044	Pedal Function	<i>Pdl Func</i>	1 (Sustain) / 2 (Arp Hold) / 3 (Hold+Sus)	*	Refer to page 43.
<b>Scale Tuning (page 38)</b>					
045	Scale	<i>Scale</i>	1 (Equal), 2 (Pure Maj), 3 (Pure min), 4 (Bayat), 5 (Rast)	1 (Equal)	Refer to page 38.
046	Base Note	<i>BaseNote</i>	01 (C), 02 (C#), 03 (D), 04 (E <sup>b</sup> ), 05 (E), 06 (F), 07 (F#), 08 (G), 09 (A <sup>b</sup> ), 10 (A), 11 (B <sup>b</sup> ), 12(B)	01 (C)	Refer to page 38.
047–058	Individual Note Tuning	<i>Tune C, C#, D, Eb, E, F, F#, G, Ab, A, Bb, B</i>	-64–63	00	Refer to page 39.
<b>Computer (USB [TO HOST] terminal)***</b>					
059	PC mode	<i>PC mode</i>	OFF/PC1/PC2	OFF	Optimizes the MIDI settings when you connect to a computer
<b>MIDI***</b>					
060	Local Control	<i>Local</i>	ON/OFF	ON	Determines whether the instrument's keyboard controls the internal tone generator (ON) or not (OFF). When you record your keyboard performance to the application software on the computer via MIDI, set this parameter to OFF.
061	External Clock	<i>ExtClock</i>	ON/OFF	OFF	Determines whether the instrument synchronizes to the internal clock (OFF) or an external clock (ON). When you record your keyboard performance to the application software on the computer via MIDI, set this parameter to ON.
062	Keyboard Out	<i>KbdOut</i>	ON/OFF	ON	Determines whether MIDI messages generated via keyboard performance are transmitted (ON) or not (OFF) from the USB [TO HOST] terminal.
063	Style Out	<i>StyleOut</i>	ON/OFF	OFF	Determines whether MIDI messages generated via Style playback are transmitted (ON) or not (OFF) from the USB [TO HOST] terminal.
064	Song Out	<i>SongOut</i>	ON/OFF	OFF	Determines whether MIDI messages generated via Song playback are transmitted (ON) or not (OFF) from the USB [TO HOST] terminal.
065	Initial Send	<i>InitSend</i>	YES/NO	-	Lets you send the data of the panel settings to a computer. Press [+ /YES] to send, or press [- /NO] to cancel. This operation should be done immediately after starting the Recording operation on the computer.
<b>Metronome (page 19)</b>					
066	Time Signature Numerator	<i>Timesign</i>	00–60	**	Determines the time signature of the Metronome.
067	Time Signature Denominator	<i>TimesignD</i>	Half note, Quarter note, Eighth note, Sixteenth note	**	Determines the length of each metronome beat.
068	Metronome Volume	<i>MtrVol</i>	000–127	100	Determines the volume of the Metronome.
<b>Lesson (page 27)</b>					
069	Lesson Track (R)	<i>R-Part</i>	GuideTrack01–16, OFF	01	Determines the guide track number for your right hand lesson. The setting is only effective for Songs in SMF format 0, in USB flash memory or transferred from a computer.
070	Lesson Track (L)	<i>L-Part</i>	GuideTrack01–16, OFF	02	Determines the guide track number for your left hand lesson. The setting is only effective for Songs in SMF format 0, in USB flash memory or transferred from a computer.
071	Grade	<i>Grade</i>	ON/OFF	ON	Determines whether the Grade function is on or off.
072	Your Tempo	<i>YourTemp</i>	ON/OFF	ON	This parameter is for Lesson 3 “Waiting.” When set to ON, playback tempo will change to match the speed at which you are playing. When set to OFF, playback tempo will be maintained regardless of the speed at which you are playing.

Function Number	Function	Display	Range/Settings	Default Value	Description
<b>Demo (page 25)</b>					
073	Demo Group	<i>DemoGrp</i>	1 (Demo) / 2 (Preset) / 3 (User) / 4 (Download) / 5 (USB)	1 (Demo)	Refer to page 50.
074	Demo Play Mode	<i>PlayMode</i>	1 (Normal) 2 (Random)	1 (Normal)	Refer to page 50.
075	Demo Cancel	<i>D-Cancel</i>	ON/OFF	OFF	Determines whether Demo cancel is enabled or not. When this is set to ON, the Demo Song will not play, even if the [DEMO/BGM] button is pressed.
<b>Auto Power Off (page 15)</b>					
076	Auto Power Off Time	<i>AutoOff</i>	OFF, 5/10/15/30/60/120 (min.)	30 minutes	Specifies the time that will elapse before the instrument's power is automatically turned off.
<b>Battery (page 13)</b>					
077	Battery Type	<i>Battery Type</i>	1 (Alkaline) / 2 (Ni-MH)	1 (Alkaline)	Selects the type of batteries you have installed to this instrument.
<b>Language (page 58)</b>					
078	Language	<i>Language</i>	English/Japanese	English	Determines the language for the Song file names.

\* The appropriate value is automatically set for each Voice.

\*\* The appropriate value is automatically set for each Song, Style or Pattern.

\*\*\* For details, refer to "Computer-related Operations" (page 9).

# USB Flash Memory Operations

By connecting the USB flash memory device to the USB [TO DEVICE] terminal, you can save the data created on this instrument, such as User Song and parameter settings. The saved data can be recalled to this instrument again for the future use.

## IMPORTANT

- It is recommended to use the Power Adaptor when executing USB flash memory operations, since battery power may not be reliable enough to last through these crucial operations. When you try executing certain functions, the “Use Adaptor” indication may appear and the selected function cannot be executed.

## Precautions when using the USB [TO DEVICE] terminal

This instrument features a built-in USB [TO DEVICE] terminal. When connecting a USB device to the terminal, be sure to handle the USB device with care. Follow the important precautions below.

### NOTE

- For more information about the handling of USB devices, refer to the owner's manual of the USB device.

### ● Compatible USB devices

- USB flash memory

Other USB devices such as a computer keyboard or mouse cannot be used. Although USB devices 1.1 to 3.0 can be used on this instrument, the amount of time for saving to or loading from the USB device may differ depending on the type of data or the status of the instrument. The instrument does not necessarily support all commercially available USB devices. Yamaha cannot guarantee operation of USB devices that you purchase. Before purchasing a USB device for use with this instrument, please visit the following web page:

<http://download.yamaha.com/>

### NOTE

- The rating of the USB [TO DEVICE] terminal is a maximum of 5V/500mA. Do not connect USB devices having a rating above this, since this can cause damage to the instrument itself.

### ● Connecting USB device

- When connecting a USB device to the USB [TO DEVICE] terminal, make sure that the connector on the device is appropriate and that it is connected in the proper direction.

### NOTICE

- Avoid connecting or disconnecting the USB device while executing playback/recording and file management operations (such as Save, Copy, Delete and Format), or when accessing the USB device. Failure to observe this may result in “freezing” of the operation of the instrument or corruption of the USB device and the data.
- When connecting then disconnecting the USB device (and vice versa), make sure to wait a few seconds between the two operations.

### NOTE

- When connecting a USB cable, make sure that the length is less than 3 meters.

## Using USB Flash Memory

By connecting the instrument to a USB flash memory, you can save data you've created to the connected device, as well as read data from the connected device.

### NOTE

- Although CD-R/RW drives can be used to read data to the instrument, they cannot be used for saving data.

### ● The number of USB flash memory to be used

Only one USB flash memory device can be connected to the USB [TO DEVICE] terminal.

### ● Formatting USB flash memory

You should format the USB storage device only with this instrument (page 58). A USB flash memory formatted on another device may not operate properly.

### NOTICE

- The format operation overwrites any previously existing data. Make sure that the USB flash memory you are formatting does not contain important data.

### ● To protect your data (write-protect)

To prevent important data from being inadvertently erased, apply the write-protect provided with each USB flash memory. If you are saving data to the USB flash memory, make sure to disable write-protect.

### ● Turning off the instrument

When turning off the instrument, make sure that the instrument is NOT accessing the USB flash memory by playback/recording or file management (such as during Save, Copy, Delete and Format operations). Failure to do so may corrupt the USB flash memory and the data.

## Connecting a USB Flash Memory

- 1 Connect a USB flash memory to the USB [TO DEVICE] terminal, being careful to insert it with the proper orientation.

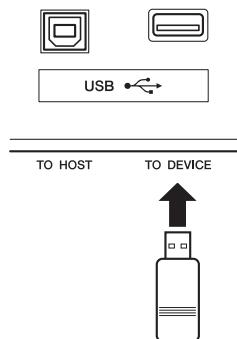

- 2 Wait until “USB” appears on the left corner of the display.

The “USB” indication confirms that the connected USB flash memory has been mounted or recognized.

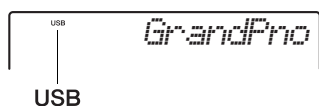

- 3 Hold down the [FUNCTION] button for longer than a second to call up the File Control display.



Hold for longer than a second.

- If “UnFormat” followed by “Format?” appears:

This indicates that the connected USB flash memory has not been formatted, and cannot be mounted or recognized. Execute the Format operation by following the instructions starting with Step 2 on page 58.

- 4 Use the CATEGORY [+] and [-] buttons to call up the desired File Control function, then execute it.

For details, refer to the table below.

File Control Display List

Display	File Control function	Page
<i>Format?</i>	Formatting a USB Flash Memory	58
<i>Save USR</i>	Saving User Data to a USB Flash Memory	59
<i>Save SMF</i>	Saving a User Song as SMF to a USB Flash Memory	60
<i>Load USR</i>	Loading User Data from a USB Flash Memory	60
<i>Load STY</i>	Loading a Style File	61
<i>Del USR</i>	Deleting a User File in a USB Flash Memory	62
<i>Del SMF</i>	Deleting a SMF File in a USB Flash Memory	62
<i>Exit?</i>	Exiting from a File Control display	63

Messages may appear on the display during File Control procedures to aid in smooth operation. Refer to the Message List on page 63 for details.

**NOTE**

- No sound will be produced if the keyboard is played while the file control display is showing, and only buttons related to File Control operations will be active.

**NOTE**

The File Control display cannot be called up in the following situations.

- During playback of Style, Pattern, or Song
- When “USB” does not appear even if you have connected a USB flash memory to the USB [TO DEVICE] terminal.

## Formatting a USB Flash Memory

The Format operation lets you prepare commercially available USB flash memory for use with this instrument is called “Format.”

- 1 Hold the [FUNCTION] button for longer than a second to call up the File Control display.
- 2 Use the CATEGORY [+] and [-] buttons to call up “Format?.”



- 3 Press the [0/EXECUTE] button. A confirmation message will appear. To cancel the operation, press the [-/NO] button.

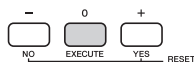

- 4 Press the [0/EXECUTE] button again or the [+ /YES] button to execute the Format operation.

After a while, a message indicating completion of the operation appears, and the “USER FILES” folder will be created on the root directory in the USB flash memory.

### NOTICE

- The Format operation cannot be cancelled during execution. Never turn off the power or disconnect the USB flash memory during the operation. Doing so may result in data loss.

- 5 Press the [FUNCTION] button to exit from the File Control display.



## Recognizable file location in the USB flash memory for Song playback (page 25)

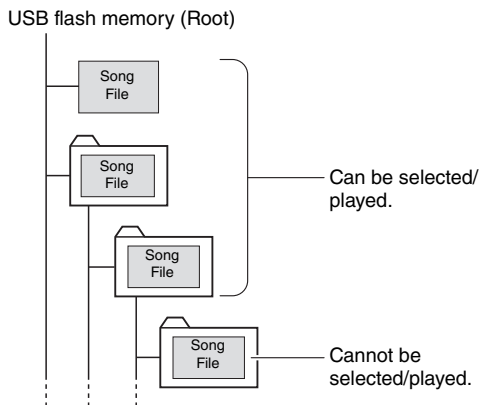

### IMPORTANT

- In order to play data copied to a USB flash memory from a computer or other device, the data must be stored either in the USB flash memory’s root directory or a first-level/second-level folder in the root directory. Data stored in third-level folders created inside a second-level folder cannot be selected and played by this instrument.

### NOTE

- If playback of an external Song (created via a different instrument or computer) produces the distorted sound, decrease the Song Volume (page 51) to reduce the distortion then adjust the Master Volume (page 15).

## Song title display language

File names containing Japanese katakana characters will be properly displayed if the instrument’s display language is set to “Japanese.” All display information other than file names will be displayed in English even if “Japanese” is selected. The display language can be set via the Language function (page 55).

## Saving User Data to a USB Flash Memory

The following data created on this instrument comprise the “User Data.”

- All 10 User Songs
- Styles which have been transferred from a computer then loaded to Style numbers 201–205.
- All the Registration Memory settings

The User Data can be saved as a single “User File” (.usr) to a USB flash memory.

**NOTE**

- The extension (.usr) of the User File will not be shown on the display of this instrument. Confirm the extension on the computer display when connecting the USB flash memory to a computer.

**1 Hold the [FUNCTION] button for longer than a second to call up the File Control display.**

**2 Use the CATEGORY [+] and [-] buttons to call up “Save USR.”**



**3 Press the [0/EXECUTE] button.**

As the target file name, “USER\*\*\*” (\*\*\*: number) appears on the display. If desired, rotate the dial to select a different file name from “USER001”–“USER100.”



**4 Press the [0/EXECUTE] button again.**

A confirmation message will appear. To cancel the operation, press the [-/NO] button.

**Overwriting existing files**

If a file that already contains data is selected as the target user file, an overwrite confirmation message will appear.

**5 Press the [0/EXECUTE] button again, or the [+ /YES] button to execute the Save operation.**

After a while, a message indicating completion of the operation appears, and a User file (.usr) will be saved in a “USER FILES” folder which will automatically be created on the USB flash memory.

**NOTICE**

- The Save operation cannot be cancelled during execution. Never turn off the power or disconnect the USB flash memory during the operation. Doing so may result in data loss.

**NOTE**

- The amount of time required for this operation may vary depending on the condition of the USB flash memory.

**6 Press the [FUNCTION] button to exit from the File Control display.**



**NOTE**

- If you want to recall the User file (.usr) to this instrument again, execute the Load operation (page 60).

## Saving a User Song as SMF to a USB Flash Memory

A User Song can be converted to SMF (Standard MIDI File) format 0 and saved to a USB flash memory.

### SMF (Standard MIDI File) format

With this format, various events via the keyboard performance such as note on/off and Voice selection will be recorded as MIDI data. The SMF Format 0 and Format 1 are available. A large number of MIDI devices are compatible with SMF Format 0, and most commercially available Song file (MIDI file) is provided in SMF Format 0.

**NOTE**

- The User Song recorded Pattern cannot be converted to SMF

**1 Hold the [FUNCTION] button for longer than a second to call up the File Control display.**

**2 Use the CATEGORY [+] and [-] buttons to call up “Save SMF.”**



**3 Press the [0/EXECUTE] button.**

As the target User Song, “USER\*\*” (\*\*: number 1–10) appears on the display. If desired, rotate the dial to select a different User Song from “USER01”–“USER10” then press the [0/EXECUTE] button.

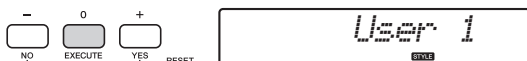

**4 Press the [0/EXECUTE] button again.**

As the target file name on the USB flash memory, “SONG\*\*\*” (\*\*\*: number 1–100) appears on the display. If desired, rotate the dial to select the different file.

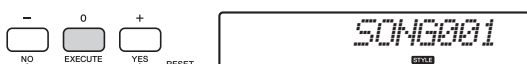

**5 Press the [0/EXECUTE] button again.**

A confirmation message will appear. To cancel the operation, press the [-/NO] button.

### Overwriting existing files

If a file that already contains data is selected, an overwrite confirmation message will appear.

**6 Press the [0/EXECUTE] button again, or the [+ /YES] button to execute the Save operation.**

After a while, a message indicating completion of the operation appears, and a User Song will be saved as the SMF format 0 in a “USER FILES” folder which will automatically be created on the USB flash memory.

### NOTICE

- The Save operation cannot be cancelled during execution. Never turn off the power or disconnect the USB flash memory during the operation. Doing so may result in data loss.

**NOTE**

- The amount of time required for this operation may vary depending on the condition of the USB flash memory.
- In case a Pattern is recorded to the User Song, the Save operation cannot be executed by pressing the [0/EXECUTE] button or the [+ /YES] button, and “Can’tUse” appears on the display.

**7 Press the [FUNCTION] button to exit from the File Control display.**



## Loading User Data from a USB Flash Memory

A User data (page 59) saved as a User file (.usr) to the USB flash memory can be loaded to this instrument.

### NOTICE

- Loading a User file will overwrite and erase the existing data, including all 10 User Songs, Style data loaded to the Style numbers 201–205, and all the Registration Memory settings. Save important data you want to keep to a separate USB flash memory before loading a User file.



1 Hold the [FUNCTION] button for longer than a second to call up the File Control display.

2 Use the CATEGORY [+] and [-] buttons to call up “Load USB.”



3 Press the [0/EXECUTE] button.

“USER\*\*\*” (\*\*\*: number) appears on the display as the User file name in the USB flash memory. As desired, rotate the dial to select a different User file.



Note that the User file should be saved in the USERFILES folder on the USB flash memory. Files saved outside this folder cannot be recognized.

4 Press the [0/EXECUTE] button again.

A confirmation message will appear. To cancel the operation, press the [-/NO] button.

5 Press the [0/EXECUTE] button again, or the [+ /YES] button to execute the Load operation.

After a while, a message indicating completion of the operation appears.

**NOTICE**

- The Load operation cannot be cancelled during execution. Never turn off the power or disconnect the USB flash memory during the operation. Doing so may result in data loss.

6 Press the [FUNCTION] button to exit from the File Control display.

7 Check the loaded data by calling up the User Song, one of the Styles 201–205, and Registration Memory settings.

## Loading a Style File

Style data created on another instrument or a computer can be loaded to the Style numbers 201–205, and you can play them like the internal preset Styles. The following two Load operations are available.

- Loading of a Style file (.sty) saved on the root directory on the USB flash memory
- Loading of a Style file (.sty) transferred from a computer via the Musicsoft Downloader and stored in the internal memory of this instrument

**NOTE**

- For instructions on transferring a Style file from a computer via the Musicsoft Downloader, refer to “Computer-related Operations” (page 9). After data transfer, load the Style data to one of the Style numbers 201–205 to enable playback.

**NOTICE**

- Loading a Style file will overwrite and erase the existing data of the destination number. Save important data you want to keep to a separate USB flash memory before loading.

1 Hold the [FUNCTION] button for longer than a second to call up the File Control display.

2 Use the CATEGORY [+] and [-] buttons to call up “Load STY.”



3 Press the [0/EXECUTE] button.

A name of a Style file in the USB flash memory or internal memory of this instrument will appear on the display. As desired, rotate the dial to select a different Style file.



4 Press the [0/EXECUTE] button again.

As the Load destination, “Load To? \*\*\*” (\*\*\*: 201–205) appears on the display. If desired, rotate the dial to select a different number.



**5 Press the [0/EXECUTE] button again.**  
A confirmation message will appear. To cancel the operation, press the [-/NO] button.

**6 Press the [0/EXECUTE] button again, or the [+ /YES] button to execute the Load operation.**  
After a while, a message indicating completion of the operation appears.

**NOTICE**

- The Load operation cannot be cancelled during execution. Never turn off the power or disconnect the USB flash memory during the operation. Doing so may result in data loss.

**7 Press the [STYLE] button, rotate the dial to select a Style from 201–205, then try playing it back.**

## Deleting a User File in the USB Flash Memory

User Files (.usr) in the root directory of the USB flash memory can be deleted.

**IMPORTANT**

- The User file (.usr) to be deleted should have been saved in the root directory of the USB flash memory. Files outside this folder cannot be recognized.

- 1 Hold the [FUNCTION] button for longer than a second to call up the File Control display.**
- 2 Use the CATEGORY [+] and [-] buttons to call up “Del USR.”**



**3 Press the [0/EXECUTE] button.**  
As a User file name in the USB flash memory, “USER\*\*\*\*” (\*\*\*\*: number) appears on the display. As desired, rotate the dial to select a different User file.

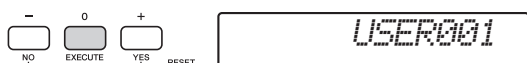

**4 Press the [0/EXECUTE] button again.**  
A confirmation message will appear. To cancel the operation, press the [-/NO] button.

**5 Press the [0/EXECUTE] button again, or the [+ /YES] button to execute the Delete operation.**  
After a while, a message indicating completion of the operation appears.

**NOTICE**

- The Delete operation cannot be cancelled during execution. Never turn off the power or disconnect the USB flash memory during the operation. Doing so may result in data loss.

**6 Press the [FUNCTION] button to exit from the File Control display.**

## Deleting a SMF File in the USB Flash Memory

You can delete a SMF file that has been saved in the USB flash memory via the Save SMF operation (page 60).

**IMPORTANT**

- The SMF file (.usr) to be deleted should have been saved in the root directory of the USB flash memory. Files outside this folder cannot be recognized. This operation can be applied only to file names with the “SONG\*\*\*\*” (\*\*\*\*: 001–100) format.

- 1 Hold the [FUNCTION] button for longer than a second to call up the File Control display.**
- 2 Use the CATEGORY [+] and [-] buttons to call up “Del SMF.”**



**3 Press the [0/EXECUTE] button.**  
As a SMF file name in the USB flash memory, “SONG\*\*\*\*” (\*\*\*\*: number) appears on the display. As desired, rotate the dial to select a different SMF file.

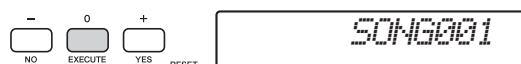

**4 Press the [0/EXECUTE] button again.**

A confirmation message will appear. To cancel the operation, press the [-/NO] button.

**5 Press the [0/EXECUTE] button again, or the [+ /YES] button to execute the Delete operation.**

After a while, a message indicating completion of the operation appears.

**NOTICE**

- *The Delete operation cannot be cancelled during execution. Never turn off the power or disconnect the USB flash memory during the operation. Doing so may result in data loss.*

**6 Press the [FUNCTION] button to exit from the File Control display.**

**Exiting from a File Control display**

To exit from the File Control display, press the [VOICE], [STYLE], [PATTERN], [SONG], [FUNCTION], or [PORTABLE GRAND] button.

You can also exit from the File Control function mode as follows:

**1 Use the CATEGORY [+ ] and [- ] buttons to call up “Exit?.”**



**2 Press the [0/EXECUTE] button to exit from the File Control display.**

**Message List**

Message	Comment
Can'tUse	<ul style="list-style-type: none"> <li>• Indicates that the file control function is currently unavailable since the media is being accessed.</li> <li>• Displayed when attempting to save a User Song recorded Pattern as SMF format 0.</li> </ul>
Comple.	Indicates the specified job completion such as data saving and transmission.
Data Err	Displayed when the user song contains illegal data.
Disk Ful	Displayed when saving data cannot be executed since the media memory becomes full.
Error	Displayed when a file error or operational error occurs.
File Ful	Indicates that SMF songs cannot be displayed since the total number of files exceeds the capacity.
no data	There is no data to save in the flash memory.
no file	There is no file to load or delete from the media.
	Communication with the USB device has been shut down because of the overcurrent to the USB device. Disconnect the device from the USB [TO DEVICE] terminal, then turn on the power of the instrument.
Protect	Displayed when trying to save or delete data on a protected media, or format a protected media. Set protect to off and try again.
UnFormat	Displayed when connecting an unformatted media.
UseAdpt	USB flash memory save, delete, and format operations cannot be performed when the instrument is being powered from battery. Use an AC adaptor.

# Troubleshooting

Problem	Possible Cause and Solution
When the instrument is turned on or off, a popping sound is temporarily produced.	This is normal and indicates that the instrument is receiving electrical power.
When using a mobile phone, noise is produced	Using a mobile phone in close proximity to the instrument may produce interference. To prevent this, turn off the mobile phone or use it further away from the instrument
The instrument is automatically turned off even if no operation is done.	This is normal. This occurs due to the Auto Power Off function (page 15).
The volume is too soft. The sound quality is poor. The Style/Pattern/Song/Arpeggio stops unexpectedly or will not play. The recorded data of the song, etc. does not play correctly. The LCD display suddenly goes dark, and all panel settings are reset.	The batteries are low or dead. Replace all six batteries with completely new ones or completely recharged ones, or use the AC power adaptor.
No sound is produced even when the keyboard is played, or a Song, Style, or Pattern is being played back.	Check whether a set of headphones or an audio cable is connected to the [PHONES/OUTPUT], or not. When such a connection is made, no sound is output from the speaker of this instrument.
	Check the on/off status of the Local Control (page 54). Normally, set this parameter to ON.
The footswitch (for sustain) seems to produce the opposite effect. For example, pressing the footswitch cuts off the sound and releasing it sustains the sounds.	The polarity of the footswitch is reversed. Make sure that the footswitch plug is properly connected to the SUSTAIN jack before turning on the power.
No sound is produced even when playing keys in the right hand area of the keyboard, although chords played in the left hand area are recognized.	Check whether or not the Dictionary function (page 49) is used. When used, this is normal.
Not all of the Voices seem to sound, or the sound seems to be cut off, when playing the keyboard, Arpeggio, Style or Pattern or Song.	You have exceeded 32 simultaneous notes, which is the maximum polyphony (the maximum amount of notes that can be played simultaneously) of this instrument. If the Main, Dual, and Split Voices are being used along with playback of Arpeggio, Style, Pattern or Song, some notes/sounds may be omitted (or "stolen").
The sound of the Voice changes from note to note.	This is normal. The tone generation method uses multiple recordings (samples) of an instrument across the range of the keyboard; thus, the actual sound of the Voice may be slightly different from note to note.
The keyboard performance and playback of Style/Pattern/Song produces an unexpected or inappropriate sound, and cannot be restored to the normal status.	Using the Knobs can produce dramatic changes in the sound, but may also produce unexpected or undesired sounds. If you want to restore the original, normal sound before being changed by the Knobs, change the Voice, Style, Pattern or Song, or press the [PORTABLE GRAND] button to reset the panel settings.
The Style, Pattern or Song does not start even when the [START/STOP] button is pressed. The Arpeggio does not start even when the note is pressed with the Arpeggio turned on.	Check the on/off status of the External Clock (page 54). Normally, set this parameter to OFF.
The volume of the Style, Pattern or Song is too low.	Check the volume setting in the Functions (pages 47 and 51).
The chords played in the left hand area cannot be recognized even when the ACMP is turned on.	Check the Split Point setting (page 47). Set this to the appropriate value.
Style parts other than the Rhythm part produce no sound.	Check the on/off status of the ACMP (page 23). Make sure to turn ACMP on.
The Styles numbered 176 or 188–200 produce no rhythm drum sound even when the [START/STOP] button is pressed.	This is normal. Style numbers 176 and 188–200 have no rhythm parts, so no rhythm will play. When one of these Styles is selected, turn ACMP on, then specify the chord in the left hand area to play Style parts other than the Rhythm part.
The ACMP indicator does not appear on the display when the [ACMP ON/OFF] button is pressed.	Check the on/off status of the [STYLE] lamp. When using a Style, press the [STYLE] button to turn on the [STYLE] lamp.

# Specifications

<b>Size/Weight</b>	Dimensions (W x D x H)		946mm x 405mm x 140mm (37-1/4" x 15-15/16" x 5-1/2")		
	Weight		6.8kg (15lbs 0oz.) (not including batteries)		
<b>Keyboard</b>	Number of Keys		61		
	Touch Response		Soft, Medium, Hard, Fixed		
<b>Other Controllers</b>	Pitch Bend		Yes		
	Control Knobs		Yes		
<b>Display</b>	Display		LCD display		
	Language		English		
<b>Voices</b>	Tone Generation	Tone Generating Technology	AWM Stereo Sampling		
	Polyphony	Number of Polyphony (Max.)	32		
	Preset	Number of Voices	234 panel Voices + 24 Drum/SFX kits + 40 Arpeggio + 457 XGlite Voices		
	Compatibility		GM, XGlite		
<b>Effects</b>	Types	Reverb	9 types		
		Chorus	5 types		
		Master EQ	6 types		
		Harmony	26 types		
		Ultra-Wide Stereo	3 types		
	Functions	Dual	Yes		
		Split	Yes		
		Arpeggio type	150 types		
		Melody Suppressor	Yes		
<b>Accompaniment Styles</b>	Preset	Number of Preset Styles	200		
		Fingering	Multi finger		
		Style Control	ACMP ON/OFF, SYNC START, SYNC STOP, START/STOP, INTRO/ENDING/rit., MAIN/AUTO FILL, TRACK ON/OFF		
	External Styles	5			
Other Features	Music Database	305			
<b>Pattern</b>	Preset	Preset Patterns	20		
		Sections	5		
<b>Recording/Playback</b> (MIDI data only; audio not supported.)	Preset	Number of Preset Songs	30		
		Number of Songs	10		
	Recording	Number of Tracks		6 (5 Melody + 1 Style/Pattern)	
		Data Capacity		Approx. 19,000 notes (when only "melody" tracks are recorded)	
		Playback	SMF Formats 0 & 1		
Compatible Data Format	Recording		Original File Format (SMF0 conversion function)		
<b>Function</b>	Lesson/Guide		[1 LISTENING 2 TIMING 3 WAITING], [Repeat & Learn], [Chord Dictionary]		
	Registration	Number of Buttons	4 (x8 banks)		
	Overall	Metronome		Yes	
		Tempo Range		11 – 280	
		Transpose		-12 to 0, 0 to +12	
		Tuning		427.0 – 440.0 – 453.0 Hz (approx. 0.2Hz increments)	
		Scale		Yes	
	Miscellaneous	One Touch Setting (OTS)		Yes	
		Portable Grand Button		Yes	
	<b>Memory/Connectivity</b>	Memory	Internal Memory		Approx. 1.54MB
			External Storage Device		USB flash memory
Connectivity		DC IN		DC IN 12V	
		Headphones/Output		[PHONES/OUTPUT] x 1	
		Sustain Pedal		[SUSTAIN] x 1	
		USB TO DEVICE		Yes	
		USB TO HOST		Yes	
AUX IN (Stereo-mini)		Yes			
<b>Amplifiers/Speakers</b>	Amplifiers		2.5W+2.5W		
	Speakers		12cmx2 + 3cmx2		
<b>Power Supply</b>	Power Supply	Adaptor	Users within U.S or Europe: PA-150 or an equivalent recommended by Yamaha Others: PA-5D, PA-150 or an equivalent		
		Batteries	Six "AA" size alkaline (LR6), manganese (R6) or Ni-MH rechargeable batteries		
	Power Consumption	15W (PA-150)			
		Auto Power Off Function		Yes	
<b>Accessories</b>	Included Accessories		<ul style="list-style-type: none"> <li>Owner's Manual</li> <li>Data List</li> <li>AC Power Adaptor</li> <li>PA-150 or an equivalent</li> <li>* May not be included depending on your particular area. Please check with your Yamaha dealer.</li> <li>Music Rest</li> <li>Online Member Product Registration</li> </ul>		
	Optional Accessories		<ul style="list-style-type: none"> <li>AC Power Adaptor: <ul style="list-style-type: none"> <li>Users within U.S or Europe: PA-150 or an equivalent recommended by Yamaha</li> <li>Others: PA-5D, PA-150 or an equivalent</li> </ul> </li> <li>Keyboard Stand (L-2C)</li> <li>Stereo Headphones (HPE-150/HPE-30)</li> <li>Footswitch (FC4/FC5)</li> <li>USB MIDI Interface for iPhone/iPod touch/iPad (i-UX1)</li> </ul>		

\* Specifications and descriptions in this owner's manual are for information purposes only. Yamaha Corp. reserves the right to change or modify products or specifications at any time without prior notice. Since specifications, equipment or options may not be the same in every locale, please check with your Yamaha dealer.

<b>A</b>		<b>D</b>		<b>H</b>	
A-B Repeat .....	26	Data Err .....	63	Harmony .....	20, 53
AC Power Adaptor .....	8, 12	Del SMF .....	57, 62	Harmony Type .....	20, 53
Accessories .....	8	Del USR .....	57, 62	Harmony Volume .....	53
ACMP .....	23, 44	Demo Cancel .....	55	Headphones .....	14
Arpeggio .....	21, 24, 43, 54	Demo Group .....	55		
Arpeggio Quantize .....	43, 54	Demo Play Mode .....	55	<b>I</b>	
Arpeggio Type .....	21, 54	Demo Song .....	25	Individual Note Tuning .....	54
Arpeggio Velocity .....	54	Disk Full .....	63	Initial Send .....	54
ATTACK .....	41	Display .....	16	Initialization .....	34
Attack Time .....	53	Dual Voice .....	18, 40, 53	INTRO .....	44
Audio file .....	8, 25, 30, 34			iPad/iPhone .....	34
Auto Accompaniment .....	44	<b>E</b>		iPhone/iPad Connection Manual ..	9
Auto Accompaniment range .....	23	EFFECT .....	22, 41		
AUTO FILL .....	44	EG (Envelope Generator) .....	22, 41	<b>K</b>	
Auto Power Off .....	15, 55	ENDING .....	44	Keyboard Out .....	54
Auto Power Off Time .....	55	EQ Setting .....	37	Knob .....	22, 24, 41
AUX IN .....	22, 41	Equal .....	38	Knob assignment .....	16
Aux In Volume .....	52	Error .....	63		
		Excellent .....	28	<b>L</b>	
<b>B</b>		Exit .....	57, 63	Language .....	55
Backup .....	34	External Audio Device .....	29	Lesson .....	27, 54
Backup Clear .....	34	External Clock .....	54	Lesson Track .....	54
Backup parameters .....	34			Limitations while recording .....	31
BALANCE .....	41	<b>F</b>		Listen .....	27
Base Note .....	38, 54	Fast Forward .....	26	Load STY .....	57, 61
Battery .....	13, 55	Fast Reverse .....	26	Load USR .....	57, 61
Battery Type .....	13, 55	File Control Display List .....	57	Local Control .....	54
Bayat .....	38	File Full .....	63		
Beat .....	16	FILTER .....	22, 41	<b>M</b>	
BGM (Background Music) .....	50	Filter Cutoff .....	53	MAIN .....	44
		Filter Resonance .....	53	Main Voice .....	17, 53
<b>C</b>		Fine Tuning .....	36	Master EQ .....	37
Can't Use .....	63	Flash Clear .....	34	Master EQ Type .....	37, 53
Chord .....	16, 47	Footswitch .....	14, 43	MASTER VOLUME .....	15
Chord Dictionary .....	49	Format .....	57, 58	MEASURE .....	16
Chord Type .....	48	Front Panel .....	10	Melody Suppressor .....	29
CHORUS .....	41	Function .....	16, 52	Melody Voice .....	51
Chorus Depth .....	53	Function List .....	52	Message List .....	63
Chorus Type .....	35, 53			Metronome .....	19, 54
Complet. ....	63	<b>G</b>		Metronome Tempo .....	19
Computer .....	34, 54	GM System Level 1 .....	8	Metronome Volume .....	19, 54
Computer-related Operations .....	9	Good .....	28	MIDI .....	54
CUTOFF .....	41	Grade .....	28, 54	MIDI Basics .....	9
				MIDI Reference .....	9
				Music Database .....	23
				Music Rest .....	8

- N**
- no data ..... 63
  - no file ..... 63
  - Notation ..... 16
- O**
- Octave ..... 53
  - OK ..... 28
  - One Touch Setting ..... 36
  - Optional Song ..... 25
  - Original Scale ..... 39
  - OTS ..... 36
- P**
- Pan ..... 53
  - Panel Settings ..... 33
  - Pattern ..... 24, 44, 46
  - Pattern Volume ..... 47, 52
  - Pause ..... 26
  - PC mode ..... 54
  - Pedal Function ..... 54
  - PITCH BEND ..... 36
  - Pitch Bend Range ..... 36, 52
  - Pitch Controls ..... 36
  - Power ..... 15
  - Power source ..... 13
  - Preset Scale types ..... 38
  - Preset Song ..... 25, 51
  - Preset Voice Types ..... 17
  - Press & Hold ..... 11
  - Protect ..... 63
  - Pure Major ..... 38
  - Pure Minor ..... 38
- R**
- Random ..... 50
  - Rast ..... 38
  - Rear Panel ..... 11
  - Recording ..... 30
  - Registration Memory ..... 33
  - RELEASE ..... 41
  - Release Time ..... 53
  - Repeat & Learn ..... 28
  - RESONANCE ..... 41
  - Retrigger ..... 24, 46
  - RETRIGGER RATE ..... 42
  - REVERB ..... 41
  - Reverb Depth ..... 53
  - Reverb Type ..... 35, 53
  - Rewind ..... 26
- S**
- Save SMF ..... 57, 60
  - Save USR ..... 57, 59
  - Scale ..... 38, 54
  - Scale Tuning ..... 38, 54
  - Section ..... 24, 44, 46
  - SMF (Standard MIDI File) ...60, 62
  - Song ..... 25, 50
  - Song Book ..... 9
  - Song Category ..... 25
  - Song Data ..... 9
  - Song Out ..... 54
  - Song title display language ..... 58
  - Song Volume ..... 51, 52
  - SPECIAL EFFECT ..... 22, 42
  - Specifications ..... 65
  - Split Point ..... 18, 23, 47, 52
  - Split Voice ..... 18, 40, 53
  - Style ..... 23, 44
  - STYLE FILE ..... 8
  - STYLE FILTER ..... 22, 41
  - Style Out ..... 54
  - Style Volume ..... 47, 52
  - SUPPRESSOR PAN ..... 41
  - Synchro Start ..... 23, 44
  - Synchro Stop ..... 45
- T**
- Tap Start ..... 46
  - Tempo ..... 46
  - Time Signature ..... 19, 54
  - Timing ..... 27
  - Touch Response ..... 37, 52
  - Track ..... 16, 30, 45
  - TRACK CONTROL ..... 24, 45
  - Track On/Off ..... 26
  - Transpose ..... 36, 52
  - Troubleshooting ..... 64
  - Tuning ..... 52
  - Tuning (Scale) ..... 39
- U**
- ULTRA WIDE STEREO ..... 42
  - Ultra-Wide Stereo ..... 53
  - UnFormat ..... 63
  - USB ..... 8
  - USB [TO DEVICE] ..... 56
  - USB [TO HOST] ..... 11, 54
  - USB Flash Memory ..... 56
  - UseAdpt ..... 63
  - User Data ..... 59, 60
  - User File ..... 62
  - User Song ..... 32, 60
- V**
- Very Good ..... 28
  - Voice ..... 17, 40
  - Volume ..... 52, 53
  - Volume (Pattern) ..... 47, 52
  - Volume (Song) ..... 51, 52
  - Volume (Style) ..... 47, 52
- W**
- Waiting ..... 27
  - Wide Type ..... 53
- X**
- XGlite ..... 8
- Y**
- Your Tempo ..... 27, 54

MEMO





# YAMAHA

## LIMITED 1-YEAR WARRANTY ON PORTABLE KEYBOARDS

**(NP, NPV, PSRE, EZ, DGX230, DGX530, YPG AND YPT SERIES)**

Thank you for selecting a Yamaha product. Yamaha products are designed and manufactured to provide a high level of defect-free performance. Yamaha Corporation of America ("Yamaha") is proud of the experience and craftsmanship that goes into each and every Yamaha product. Yamaha sells its products through a network of reputable, specially authorized dealers and is pleased to offer you, the Original Owner, the following Limited Warranty, which applies only to products that have been (1) directly purchased from Yamaha's authorized dealers in the fifty states of the USA and District of Columbia (the "Warranted Area") and (2) used exclusively in the Warranted Area. Yamaha suggests that you read the Limited Warranty thoroughly, and invites you to contact your authorized Yamaha dealer or Yamaha Customer Service if you have any questions.

**Coverage:** Yamaha will, at its option, repair or replace the product covered by this warranty if it becomes defective, malfunctions or otherwise fails to conform with this warranty under normal use and service during the term of this warranty, without charge for labor or materials. Repairs may be performed using new or refurbished parts that meet or exceed Yamaha specifications for new parts. If Yamaha elects to replace the product, the replacement may be a reconditioned unit. You will be responsible for any installation or removal charges and for any initial shipping charges if the product(s) must be shipped for warranty service. However, Yamaha will pay the return shipping charges to any destination within the USA if the repairs are covered by the warranty. This warranty does not cover (a) damage, deterioration or malfunction resulting from accident, negligence, misuse, abuse, improper installation or operation or failure to follow instructions according to the Owner's Manual for this product; any shipment of the product (claims must be presented to the carrier); repair or attempted repair by anyone other than Yamaha or an authorized Yamaha Service Center; (b) any unit which has been altered or on which the serial number has been defaced, modified or removed; (c) normal wear and any periodic maintenance; (d) deterioration due to perspiration, corrosive atmosphere or other external causes such as extremes in temperature or humidity; (e) damages attributable to power line surge or related electrical abnormalities, lightning damage or acts of God; or (f) RFI/EMI (Interference/noise) caused by improper grounding or the improper use of either certified or uncertified equipment, if applicable. Any evidence of alteration, erasing or forgery of proof-of-purchase documents will cause this warranty to be void. This warranty covers only the Original Owner and is not transferable.

**In Order to Obtain Warranty Service:** Warranty service will only be provided for defective products within the Warranted Area. Contact your local authorized Yamaha dealer who will advise you of the procedures to be followed. If this is not successful, contact Yamaha at the address, telephone number or website shown below. Yamaha may request that you send the defective product to a local authorized Yamaha Servicer or authorize return of the defective product to Yamaha for repair. If you are uncertain as to whether a dealer has been authorized by Yamaha, please contact Yamaha's Service Department at the number shown below, or check Yamaha's website at [www.Yamaha.com](http://www.Yamaha.com). Product(s) shipped for service should be packed securely and must be accompanied by a detailed explanation of the problem(s) requiring service, together with the original or a machine reproduction of the bill of sale or other dated, proof-of-purchase document describing the product, as evidence of warranty coverage. Should any product submitted for warranty service be found ineligible therefore, an estimate of repair cost will be furnished and the repair will be accomplished only if requested by you and upon receipt of payment or acceptable arrangement for payment.

**Limitation of Implied Warranties and Exclusion of Damages:** ANY IMPLIED WARRANTIES, INCLUDING WARRANTIES OF MERCHANTABILITY AND FITNESS FOR A PARTICULAR PURPOSE SHALL BE LIMITED IN DURATION TO THE APPLICABLE PERIOD OF TIME SET FORTH ABOVE. YAMAHA SHALL NOT BE RESPONSIBLE FOR INCIDENTAL OR CONSEQUENTIAL DAMAGES OR FOR DAMAGES BASED UPON INCONVENIENCE, LOSS OF USE, DAMAGE TO ANY OTHER EQUIPMENT OR OTHER ITEMS AT THE SITE OF USE OR INTERRUPTION OF PERFORMANCES OR ANY CONSEQUENCES. YAMAHA'S LIABILITY FOR ANY DEFECTIVE PRODUCT IS LIMITED TO REPAIR OR REPLACEMENT OF THE PRODUCT, AT YAMAHA'S OPTION. SOME STATES DO NOT ALLOW LIMITATIONS ON HOW LONG AN IMPLIED WARRANTY LASTS OR THE EXCLUSION OR LIMITATION OF INCIDENTAL OR CONSEQUENTIAL DAMAGES, SO THE ABOVE LIMITATION OR EXCLUSION MAY NOT APPLY TO YOU. This Warranty gives you specific legal rights, and you may also have other rights which vary from state to state. This is the only express warranty applicable to the product specified herein; Yamaha neither assumes nor authorizes anyone to assume for it any other express warranty.

If you have any questions about service received or if you need assistance in locating an authorized Yamaha Servicer, please contact:



# YAMAHA

CUSTOMER SERVICE

Yamaha Corporation of America

6600 Orangethorpe Avenue, Buena Park, California 90620-1373

Telephone: 800-854-1569

[www.yamaha.com](http://www.yamaha.com)

**Do not return any product to the above address without a written Return Authorization issued by YAMAHA.**

©2012 Yamaha Corporation of America.

# Important Notice: Guarantee Information for customers in European Economic Area (EEA) and Switzerland

<b>Important Notice: Guarantee Information for customers in EEA* and Switzerland</b> For detailed guarantee information about this Yamaha product, and Pan-EEA* and Switzerland warranty service, please either visit the website address below (Printable file is available at our website) or contact the Yamaha representative office for your country. * EEA: European Economic Area	<b>English</b>
<b>Wichtiger Hinweis: Garantie-Information für Kunden in der EWR* und der Schweiz</b> Für nähere Garantie-Information über dieses Produkt von Yamaha, sowie über den Pan-EWR* und Schweizer Garantieservice, besuchen Sie bitte entweder die folgende angegebene Internetadresse (eine druckfähige Version befindet sich auch auf unserer Webseite), oder wenden Sie sich an den für Ihr Land zuständigen Yamaha-Vertrieb. *EWR: Europäischer Wirtschaftsraum	<b>Deutsch</b>
<b>Remarque importante: informations de garantie pour les clients de l'EEE et la Suisse</b> Pour des informations plus détaillées sur la garantie de ce produit Yamaha et sur le service de garantie applicable dans l'ensemble de l'EEE ainsi qu'en Suisse, consultez notre site Web à l'adresse ci-dessous (le fichier imprimable est disponible sur notre site Web) ou contactez directement Yamaha dans votre pays de résidence. * EEE : Espace Economique Européen	<b>Français</b>
<b>Belangrijke mededeling: Garantie-informatie voor klanten in de EER* en Zwitserland</b> Voor gedetailleerde garantie-informatie over dit Yamaha-product en de garantieservice in heel de EER* en Zwitserland, gaat u naar de onderstaande website (u vindt een afdrukbare bestand op onze website) of neemt u contact op met de vertegenwoordiging van Yamaha in uw land. * EER: Europese Economische Ruimte	<b>Nederlands</b>
<b>Aviso importante: información sobre la garantía para los clientes del EEE* y Suiza</b> Para una información detallada sobre este producto Yamaha y sobre el soporte de garantía en la zona EEE* y Suiza, visite la dirección web que se incluye más abajo (la versión del archivo para imprimir está disponible en nuestro sitio web) o póngase en contacto con el representante de Yamaha en su país. * EEE: Espacio Económico Europeo	<b>Español</b>
<b>Aviso importante: informazioni sulla garanzia per i clienti residenti nell'EEA* e in Svizzera</b> Per informazioni dettagliate sulla garanzia relativa a questo prodotto Yamaha e l'assistenza in garanzia in garanzia nei paesi EEA* e in Svizzera, potete consultare il sito Web all'indirizzo riportato di seguito (è disponibile il file in formato stampabile) oppure contattare l'ufficio di rappresentanza locale della Yamaha. * EEA: Area Economica Europea	<b>Italiano</b>
<b>Aviso importante: informações sobre as garantias para clientes da AEE* e da Suíça</b> Para obter uma informação pormenorizada sobre este produto da Yamaha e sobre o serviço de garantia na AEE* e na Suíça, visite o site a seguir (o arquivo para impressão está disponível no nosso site) ou entre em contato com o escritório de representação da Yamaha no seu país. * AEE: Área Económica Europeia	<b>Português</b>
<b>Σημαντική σημείωση: Πληροφορίες εγγύησης για τους πελάτες στον ΕΟΧ* και Ελλάδα</b> Για λεπτομερείς πληροφορίες εγγύησης σχετικά με το προϊόν προϊόν της Yamaha και την κάλυψη εγγύησης, σε όλες τις χώρες του ΕΟΧ* και την Ελλάδα, επισκεφτείτε την παρακάτω ιστοσελίδα (Εκτυρίσιμη μορφή είναι διαθέσιμη στην ιστοσελίδα μας) ή απευθυνθείτε στην αντιπροσωπεία της Yamaha στη χώρα σας. * ΕΟΧ: Ευρωπαϊκό Οικονομικό Χώρο	<b>Ελληνικά</b>
<b>Viktig: Garantiinformasjon for kunder i EES-området* och Schweiz</b> For detaljert informasjon om denne Yamaha-produktet samt garantisevne i hele EES-området* och Schweiz kan du antingen besøke nedenstående webadresse (en utskriftsvenlig fil finns på webbplatsen) eller kontakta Yamahas officiella representant i ditt land. *EES: Europeiska Ekonomiska Samarbeidsområdet	<b>Svenska</b>
<b>Viktig merknad: Garantiinformasjon for kunder i EØS* og Sveits</b> Detaljert informasjon om dette Yamaha-produktet og garantisevne for hele EØS-området* og Sveits kan fås enten ved å besøke nettsidene nedenfor (utskriftsvenlig fil finns på nettstedet) eller kontakte Yamahas kontoret i landet der du bor. *EØS: Det europeiske økonomiske samarbeidsområdet	<b>Norsk</b>
<b>Viktig oplysning: Garantioplysninger til kunder i EØO* og Schweiz</b> De kan finde detaljerede garantioplysninger om dette Yamaha-produkt og den fælles garantisevneordning for EØO* (og Schweiz) ved at besøge det websted, der er angivet nedenfor (der findes en fil, som kan udskrives, på vores websted), eller ved at kontakte Yamahas nationale repræsentationskontor i det land, hvor De bor. * EØO: Det Europæiske Økonomiske Område	<b>Dansk</b>

<b>Tärkeä ilmoitus: Takuuehdot Euroopan talousalueen (ETA)* ja Sveitsin asiakkaille</b> Tämän Yamaha-tuotteen sekä ETA-alueen ja Sveitsin takuuta koskevat yksityiskohtaiset tiedot saatte alla olevasta nettiosoitteesta. (Tulostettava liedosto saatavissa sivustollamme.) Voitte myös ottaa yhteyttä paikalliseen Yamaha-edustajaan. *ETA: Euroopan talousalue	<b>Suomi</b>
<b>Ważne: Warunki gwarancyjne obowiązujące w EOG* i Szwajcarii</b> Aby dowiedzieć się więcej na temat warunków gwarancyjnych tego produktu firmy Yamaha i serwisu gwarancyjnego w całym EOG* i Szwajcarii, należy odwiedzić wskazaną poniżej stronę internetową (plik gotowy do wydruku znajduje się na naszej stronie internetowej) lub skontaktować się z przedstawicielstwem firmy Yamaha w swoim kraju. * EOG — Europejski Obszar Gospodarczy	<b>Polski</b>
<b>Důležité oznámení: Záruční informace pro zákazníky v EHS* a ve Švýcarsku</b> Podrobné záruční informace o tomto produktu Yamaha a záručním servisu v celém EHS* a ve Švýcarsku naleznete na níže uvedené webové adrese (soubor k tisku je dostupný na našich webových stránkách) nebo se můžete obrátit na zástupce firmy Yamaha ve své zemi. * EHS: Evropský hospodářský prostor	<b>Česky</b>
<b>Fontos figyelmeztetés: Garancia-információk az EGT* területén és Svájcban élő vásárlók számára</b> A jelen Yamaha termékre vonatkozó részletes garancia-információk, valamint az EGT*-re és Svájcra kiterjedő garanciális szolgáltatás tekintetében keressék fel webhelyünket az alábbi címen (a webhelyen nyomtatható fájl is felfal), vagy pedig lépjen kapcsolatba az országában működő Yamaha képviselői irodával. * EGT: Európai Gazdasági Térség	<b>Magyar</b>
<b>Online märkus: Garantiteave Euroopa Majanduspiirkonna (EMP)* ja Šveitsi klientidele</b> Täpsemat teabe saamiseks selle Yamaha toote garantii ning kogu Euroopa Majanduspiirkonna ja Šveitsi garantiiteeninduse kohta, külastage palun veebisaiti alljärgneval aadressil (meie saidil on saadaval printitav fail) või pöörduge Teie regiooni Yamaha esinduse poole. * EMP: Euroopa Majanduspiirkond	<b>Eesti keel</b>
<b>Svarīgs paziņojums: garantijas informācija klientiem EEZ* un Šveicē</b> Lai saņemtu detalizētā garantijas informāciju par šo Yamaha produktu, kā arī garantijas apkalpošanu EEZ* un Šveicē, lūdzam apmeklēt vietnāk norādīto tīmekļa vietnes adresi (tīmekļa vietnē ir pieejams drukājams fails) vai sazināties ar jūsu valstī apkalpojošo Yamaha pārstāvniecību. * EEZ: Eiropas Ekonomikas zona	<b>Latviešu</b>
<b>Dėmesio: informacija dėl garantijos pirkėjams EEE* ir Šveicarijoje</b> Jei reikia išsamesios informacijos apie šį „Yamaha“ produktą ir jo techninę priežiūrą visoje EEE* ir Šveicarijoje, apsilankykite mūsų svetainėje toliau nurodytu adresu (svetainėje yra spausdinamas failas) arba kreipkitės į „Yamaha“ atstovystę savo šalyje. *EEE – Europos ekonominė erdvė	<b>Lietuvių kalba</b>
<b>Dôležité upozornenie: Informácie o záruke pre zákazníkov v EHP* a Švajčiarsku</b> Podrobné informácie o záruke týkajúcej sa tohto produktu od spoločnosti Yamaha a garancijnom servise v EHP* a Švajčiarsku nájdete na webovej stránke uvedenej nižšie (na našej webovej stránke je k dispozícii súbor na tlač) alebo sa obráťte na zástupcu spoločnosti Yamaha vo svojej krajine. * EHP: Európsky hospodársky priestor	<b>Slovenčina</b>
<b>Pomembno obvestilo: Informacije o garanciji za kupce v EGP* in Šviciji</b> Za podrobnejše informacije o tem Yamahinem izdelku ter garancijskem servisu v celotnem EGP in Šviciji, obiščite spletno mesto, ki je navedeno spodaj (našljiva datoteka je na voljo na našem spletnem mestu), ali se obrnite na Yamahinega predstavnika v svoji državi. * EGP: Evropski gospodarski prostor	<b>Slovenščina</b>
<b>Важно съобщение: Информация за гаранцията за клиенти в ЕИПТ* и Швейцария</b> За подробна информация за гаранцията за този продукт на Yamaha и гаранционното обслужване в паневропейската зона на ЕИПТ* и Швейцария или посетете посочения по-долу сайт (на нашия уеб сайт има файл за печат), или се свържете с представителния офис на Yamaha във вашата страна. * ЕИПТ: Европейско икономическо пространство	<b>Български език</b>
<b>Notificare importantă: Informații despre garanție pentru clienții din SEE* și Elveția</b> Pentru informații detaliate privind acest produs Yamaha și serviciul de garanție Pan-SEE* și Elveția, vizitați site-ul la adresa de mai jos (fișierul imprimabil este disponibil pe site-ul nostru) sau contactați biroul reprezentanței Yamaha din țara dumneavoastră. * SEE: Spațiul Economic European	<b>Limba română</b>

<http://europe.yamaha.com/warranty/>

For details of products, please contact your nearest Yamaha representative or the authorized distributor listed below.

## NORTH AMERICA

### CANADA

**Yamaha Canada Music Ltd.**  
135 Milner Avenue, Toronto, Ontario,  
M1S 3R1, Canada  
Tel: 416-298-1311

### U.S.A.

**Yamaha Corporation of America**  
6600 Orangethorpe Avenue, Buena Park, CA 90620, U.S.A.  
Tel: 714-522-9011

## CENTRAL & SOUTH AMERICA

### MEXICO

**Yamaha de México, S.A. de C.V.**  
Av. Insurgentes Sur 1647 "Prisma Insurgentes",  
Col. San Jose Insurgentes, Del. Benito Juarez,  
03900, Mexico, D.F.  
Tel: 55-5804-0600

### BRAZIL

**Yamaha Musical do Brasil Ltda.**  
Rua Joaquim Floriano, 913 - 4º andar, Itaim Bibi,  
CEP 04534-013 São Paulo, SP. BRAZIL  
Tel: 011-3704-1377

### ARGENTINA

**Yamaha Music Latin America, S.A.,  
Sucursal Argentina**  
Olga Cossetini 1553, Piso 4 Norte,  
Madero Este-C1107CEK  
Buenos Aires, Argentina  
Tel: 54-11-4119-7000

### VENEZUELA

**Yamaha Music Latin America, S.A.,  
Sucursal Venezuela**  
C.C. Manzanera Plaza P4  
Ofic. 0401- Manzanera-Baruta  
Caracas Venezuela  
Tel: 58-212-943-1877

### PANAMA AND OTHER LATIN AMERICAN COUNTRIES/ CARIBBEAN COUNTRIES

**Yamaha Music Latin America, S.A.**  
Torre Banco General, Piso No.7, Marbella,  
Calle 47 y Aquilino de la Guardia,  
Ciudad de Panamá, República de Panamá  
Tel: +507-269-5311

## EUROPE

### THE UNITED KINGDOM/IRELAND

**Yamaha Music Europe GmbH (UK)**  
Sherbourne Drive, Tilbrook, Milton Keynes,  
MK7 8BL, U.K.  
Tel: 01908-366700

### GERMANY

**Yamaha Music Europe GmbH**  
Siemensstraße 22-34, 25462 Rellingen, Germany  
Tel: 04101-3030

### SWITZERLAND/LIECHTENSTEIN

**Yamaha Music Europe GmbH  
Branch Switzerland in Zürich**  
Seefeldstrasse 94, 8008 Zürich, Switzerland  
Tel: 044-387-8080

### AUSTRIA

**Yamaha Music Europe GmbH Branch Austria**  
Schleiergasse 20, A-1100 Wien, Austria  
Tel: 01-60203900

### CZECH REPUBLIC/HUNGARY/ ROMANIA/SLOVAKIA/SLOVENIA

**Yamaha Music Europe GmbH  
Branch Austria (Central Eastern Europe Office)**  
Schleiergasse 20, A-1100 Wien, Austria  
Tel: 01-60203900

### POLAND/LITHUANIA/LATVIA/ ESTONIA

**Yamaha Music Europe GmbH  
Branch Poland Office**  
ul. Wrotkowa 14 02-553 Warsaw, Poland  
Tel: 022-500-2925

### BULGARIA

**Dinacord Bulgaria LTD.**  
Bul. Iskarsko Schose 7 Targowski Zentar Ewropa  
1528 Sofia, Bulgaria  
Tel: 02-978-20-25

### MALTA

**Olimpus Music Ltd.**  
The Emporium, Level 3, St. Louis Street Msida  
MSD06  
Tel: 02133-2144

### NETHERLANDS/BELGIUM/ LUXEMBOURG

**Yamaha Music Europe Branch Benelux**  
Clarissenhof 5-b, 4133 AB Vianen, Netherlands  
Tel: 0347-358 040

### FRANCE

**Yamaha Music Europe**  
7 rue Ambroise Croizat, Zone d'activites Pariest,  
77183 Croissy-Beaubourg, France  
Tel: 01-64-61-4000

### ITALY

**Yamaha Music Europe GmbH, Branch Italy**  
Viale Italia 88, 20020 Lainate (Milano), Italy  
Tel: 02-935-771

### SPAIN/PORTUGAL

**Yamaha Music Europe GmbH Ibérica, Sucursal  
en España**  
Ctra. de la Coruna km. 17,200, 28231  
Las Rozas (Madrid), Spain  
Tel: +34-91-639-88-88

### GREECE

**Philippos Nakas S.A. The Music House**  
147 Skiathou Street, 112-55 Athens, Greece  
Tel: 01-228 2160

### SWEDEN

**Yamaha Music Europe GmbH filial  
Scandinavia**  
J. A. Wettergrensgata 1, Box 30053  
S-400 43 Göteborg, Sweden  
Tel: +46 31 89 34 00

### DENMARK

**Yamaha Music Europe GmbH, Tyskland - filial  
Denmark**  
Generatorvej 6A, DK-2730 Herlev, Denmark  
Tel: 44 92 49 00

### FINLAND

**F-Musiikki Oy**  
Kluuvikatu 6, P.O. Box 260,  
SF-00101 Helsinki, Finland  
Tel: 09 618511

### NORWAY

**Yamaha Music Europe GmbH Germany -  
Norwegian Branch**  
Grini Næringspark 1, N-1361 Østerås, Norway  
Tel: 67 16 78 00

### ICELAND

**Skifan HF**  
Skeifan 17 P.O. Box 8120, IS-128 Reykjavik,  
Iceland  
Tel: 525 5000

### RUSSIA

**Yamaha Music (Russia) LLC.**  
Room 37, bld. 7, Kievskaya street, Moscow,  
121059, Russia  
Tel: 495 626 5005

### OTHER EUROPEAN COUNTRIES

**Yamaha Music Europe GmbH**  
Siemensstraße 22-34, 25462 Rellingen, Germany  
Tel: +49-4101-3030

## AFRICA

### SOUTH AFRICA

**Global Music Instruments**  
Unit 4, 130 Boeing Road East Bedfordview 2008  
Postnet Suite 130, Private Bag X10020 Edenvale  
1610, South Africa  
Tel: 27-11-454-1131

### OTHER AFRICAN COUNTRIES

**Yamaha Music Gulf FZE**  
LOB 16-513, P.O.Box 17328, Jebel Ali,  
Dubai, United Arab Emirates  
Tel: +971-4-881-5868

## MIDDLE EAST

### TURKEY/CYPRUS

**Yamaha Music Europe GmbH**  
Merkezi Almanyaya Türkiye Istanbul Şubesi  
Maslak Meydan Sokak No:5 Spring Giz Plaza  
Bağımsız Böl. No:3, 34398 Şişli, Istanbul  
Tel: +90-212-999-8010

### OTHER COUNTRIES

**Yamaha Music Gulf FZE**  
LOB 16-513, P.O.Box 17328, Jebel Ali,  
Dubai, United Arab Emirates  
Tel: +971-4-881-5868

## ASIA

### THE PEOPLE'S REPUBLIC OF CHINA

**Yamaha Music & Electronics (China) Co.,Ltd.**  
2F, Yunhedasha, 1818 Xinzha-lu, Jingan-qu,  
Shanghai, China  
Tel: 021-6247-2211

### HONG KONG

**Tom Lee Music Co., Ltd.**  
11/F., Silvercord Tower 1, 30 Canton Road,  
Tsimshatsui, Kowloon, Hong Kong  
Tel: 2737-7688

### INDIA

**Yamaha Music India Pvt. Ltd.**  
Spazedge building, Ground Floor, Tower A, Sector  
47, Gurgaon- Sohna Road, Gurgaon, Haryana, India  
Tel: 0124-485-3300

### INDONESIA

**PT. Yamaha Musik Indonesia (Distributor)**  
Yamaha Music Center Bldg. Jalan Jend. Gatot  
Subroto Kav. 4, Jakarta 12930, Indonesia  
Tel: 021-520-2577

### KOREA

**Yamaha Music Korea Ltd.**  
8F, 9F, Dongsung Bldg. 158-9 Samsung-Dong,  
Kangnam-Gu, Seoul, Korea  
Tel: 02-3467-3300

### MALAYSIA

**Yamaha Music (Malaysia) Sdn., Bhd.**  
No.8, Jalan Perbandaran, Kelana Jaya, 47301  
Petaling Jaya, Selangor, Malaysia  
Tel: 03-78030900

### PHILIPPINES

**Yupango Music Corporation**  
339 Gil J. Puyat Avenue, P.O. Box 885 MCPO,  
Makati, Metro Manila, Philippines  
Tel: 819-7551

### SINGAPORE

**Yamaha Music (Asia) Private Limited**  
Block 202 Hougang Street 21, #02-00,  
Singapore 530202, Singapore  
Tel: 65-6747-4374

### TAIWAN

**Yamaha Music & Electronics Taiwan Co.,Ltd.**  
3F, No.6, Section 2 Nan-Jing East Road, Taipei,  
Taiwan R.O.C.  
Tel: 02-2511-8688

### THAILAND

**Siam Music Yamaha Co., Ltd.**  
3, 4, 15 and 16th floor, Siam Motors Building,  
891/1 Rama 1 Road, Wangmai,  
Pathumwan, Bangkok 10330, Thailand  
Tel: 02-215-2622

### VIETNAM

**Yamaha Music Vietnam Company Limited**  
15th Floor, Nam A Bank Tower, 201-203 Cach  
Mang Thang Tam St., Ward 4, Dist.3,  
Ho Chi Minh City, Vietnam  
Tel: +84-8-3818-1122

### OTHER ASIAN COUNTRIES

**Yamaha Corporation  
Market Development Section**  
Nakazawa-cho 10-1, Naka-ku, Hamamatsu,  
Japan 430-8650  
Tel: +81-53-460-2312

## OCEANIA

### AUSTRALIA

**Yamaha Music Australia Pty. Ltd.**  
Level 1, 99 Queensbridge Street, Southbank,  
Victoria 3006, Australia  
Tel: 3-9693-5111

### NEW ZEALAND

**Music Works LTD**  
P.O.Box 6246 Wellesley, Auckland 4680,  
New Zealand  
Tel: 9-634-0099

### COUNTRIES AND TRUST TERRITORIES IN PACIFIC OCEAN

**Yamaha Corporation  
Market Development Section**  
Nakazawa-cho 10-1, Naka-ku, Hamamatsu,  
Japan 430-8650  
Tel: +81-53-460-2312



Yamaha Global Site  
<http://www.yamaha.com/>

Yamaha Downloads  
<http://download.yamaha.com/>

C.S.G., DMI Development Division  
©2014 Yamaha Corporation

Published 03/2014 PO##\*.\*\*\*B0  
Printed in China



ZH22090

ZH22090