

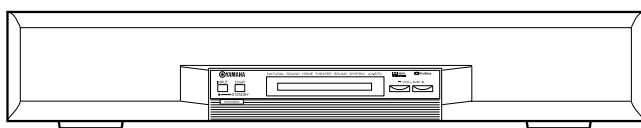

GB

# AV-S70

*Home Theater Sound System  
Système audio home cinéma*



OWNER'S MANUAL  
MODE D'EMPLOI  
BEDIENUNGSANLEITUNG  
BRUKSANVISNING  
MANUALE DI ISTRUZIONI  
MANUAL DE INSTRUCCIONES  
GEBRUIKSAANWIJZING

## CAUTION: READ THIS BEFORE OPERATING YOUR UNIT.

1. To assure the finest performance, please read this manual carefully. Keep it in a safe place for future reference.
2. Install this unit in a cool, dry, clean place — away from windows, heat sources, sources of excessive vibration, dust, moisture and cold. Avoid sources of humming (transformers, motors). To prevent fire or electrical shock, do not expose the unit to rain or water.
3. Never open the cabinet. If something drops into the unit, contact your dealer.
4. Do not use force on switches, controls or connection cables. When moving the unit, first disconnect the power cord and then the cables connected to other component. Never pull the cables themselves.
5. The openings on the cover assure proper ventilation of the unit. If these openings are obstructed, the temperature inside the unit will rise rapidly. Therefore, avoid placing objects against these openings, and install the unit in a well-ventilated area to prevent fire and damage.
6. The voltage used must be the same as that specified on this unit. Using this unit with a higher voltage than specified is dangerous and may result in fire or other accidents. YAMAHA will not be held responsible for any damage resulting from the use of this unit with a voltage other than that specified.
7. Digital signals generated by this unit may interfere with other component such as tuners, receivers and TVs. Move this unit farther away from such component if interference is observed.
8. Always set the volume to the minimum level before starting the audio source play. Increase the volume gradually to an appropriate level after playback has been started.
9. Do not attempt to clean the unit with chemical solvents; this might damage the finish. Use a clean, dry cloth.
10. Be sure to read the “TROUBLESHOOTING” section regarding common operating errors before concluding that the unit is faulty.
11. When not planning to use this unit for a long period of time (e.g., a vacation), disconnect the AC power cord from the wall outlet.
12. To prevent lightning damage, disconnect the AC power cord and disconnect the antenna cable when there is an electrical storm.
13. Grounding or polarization — Precautions should be taken so that the grounding or polarization of the unit is not defeated.
14. AC outlet — Do not connect audio component to the AC outlet on the rear panel if that component requires more power than the outlet is rated to provide.
15. Though this speaker is a magnetic shielding type, there may be some influence on a TV picture depending on the type of TV or the placement of the speaker. In such a case, place the speaker apart from the TV so that there is no influence on TV picture.

This unit is not disconnected from the AC power source as long as it is connected to the wall outlet, even if this unit itself is turned off. This state is called the standby mode. In this state, this unit is designed to consume a very small quantity of power.

### ■ For U.K. customers

If the socket outlets in the home are not suitable for the plug supplied with this appliance, it should be cut off and an appropriate 3 pin plug fitted. For details, refer to the instructions described below.

#### Note

- The plug severed from the mains lead must be destroyed, as a plug with bared flexible cord is hazardous if engaged in a live socket outlet.

### ■ Special Instructions for U.K. Model

#### IMPORTANT

THE WIRES IN MAINS LEAD ARE COLOURED IN ACCORDANCE WITH THE FOLLOWING CODE:

Blue: NEUTRAL

Brown: LIVE

As the colours of the wires in the mains lead of this apparatus may not correspond with the coloured markings identifying the terminals in your plug, proceed as follows:

The wire which is coloured BLUE must be connected to the terminal which is marked with the letter N or coloured BLACK. The wire which is coloured BROWN must be connected to the terminal which is marked with the letter L or coloured RED.

Making sure that neither core is connected to the earth terminal of the three pin plug.

## FEATURES

### ● Home Theater Sound

This system delivers a realistic and powerful sound experience like that found in a movie theater just by connecting the front speaker unit to the TV. You can also enjoy stronger bass and surround effects by adding the separately available YAMAHA NX-SW70, consisting of a subwoofer and two rear speakers.

### ● Includes Dolby Digital\* and Dolby Pro Logic Decoder

This system can reproduce the sound field of the software with the  or  logo mark.

### ● Virtual Surround

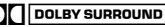
The front speaker unit can produce a virtual Dolby Surround sound field when playing software with the  or  logo mark so that you can enjoy surround effects that give motion to sound and make you feel like you are inside the action.

### ● Seven DSP programs including YAMAHA CINEMA DSP

Connecting the YAMAHA NX-SW70 (sold separately) allows seven different DSP programs to be used to enhance the power and realism of various sources, from movies, to concerts, and sporting events.

### ● Preset Remote Control

The remote control can be used to control not only the front speaker unit, but component from other manufacturers as well merely by setting the proper manufacturer code.



Manufactured under license from Dolby Laboratories. "Dolby", "Pro Logic" and the double-D symbol are trademarks of Dolby Laboratories. Confidential Unpublished Works. ©1992 – 1997 Dolby Laboratories, Inc. All rights reserved.

## CONTENTS

### PREPARATION

FEATURES .....	1	PREPARATION
GETTING STARTED .....	2	
NAMES OF ALL PARTS .....	4	
SPEAKER PLACEMENT .....	6	
INSTALLATION .....	7	
CONNECTIONS .....	9	
ADJUSTING THE SPEAKER OUTPUT LEVELS .....	15	

### OPERATION

OPERATING THE UNIT .....	17	OPERATION
USING CONVENIENT FUNCTIONS .....	18	
DSP PROGRAM (DIGITAL SOUND FIELD PROCESSOR EFFECT) .....	19	
MENU FUNCTIONS .....	21	

### REMOTE CONTROL

OPERATING OTHER COMPONENTS USING THE REMOTE CONTROL .....	23	REMOTE CONTROL
---	----	----------------

### APPENDIX

GLOSSARY .....	28	APPENDIX
TROUBLESHOOTING .....	29	
SPECIFICATIONS .....	30	
INDEX .....	31	

 indicates a tip for your operation.

# GETTING STARTED

## Checking the Package Contents

Check that the following accessories are included in the package.

Remote control



Batteries (AAA, R03, UM-4 type)

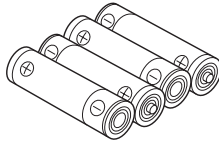

Velcro strips (2 sets)

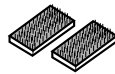

Audio connection cord (2 pin, 3m)

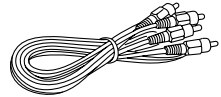

Connection guide

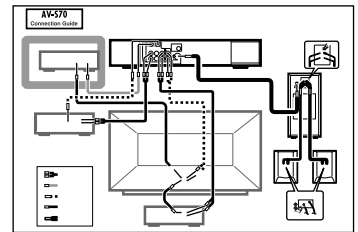

## Readying the Remote Control

### ■ Inserting the batteries

**1** Remove the battery compartment cover.

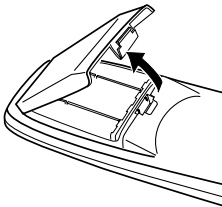

**2** Insert the four batteries (AAA, R03, UM-4 type) with + and – oriented properly.

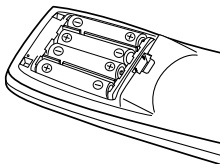

**3** Close the battery compartment cover.

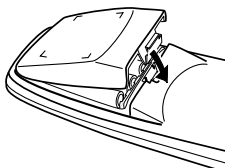

### ■ Precautions regarding batteries

Misuse of dry cell batteries may result in leakage or bursting. Be sure to follow the precautions given below.

- Insert batteries with (+) and (–) oriented according to the marking in the battery compartment.
- Do not mix old and new batteries.
- Do not mix different types of batteries as they may offer different voltage and performance even though they have the same shape.
- Remove all batteries when they can no longer be used or when the remote control will not be used for an extended period.
- Do not use rechargeable batteries.
- If leakage occurs, wipe away all battery fluid inside the compartment.

### Preserving the manufacturer code

Replace batteries early before they become unusable. The manufacturer code set by the user will be preserved for about two minutes when batteries run out or when they are removed. Note that the manufacturer code setting may be lost if more than two minutes elapses.

## Operational Area of the Remote Control

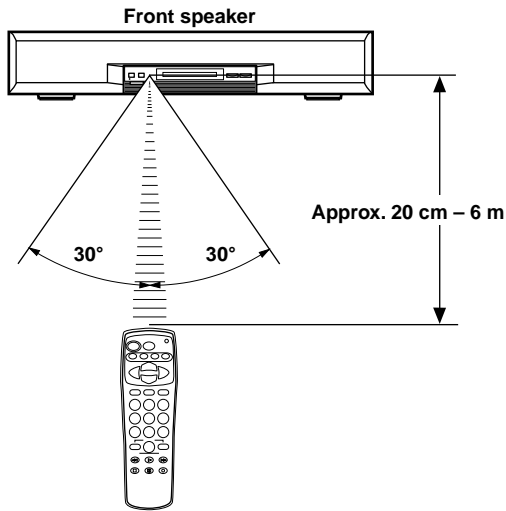

### ■ Battery replacement cycle

Replace all four batteries when the operational range of the remote control starts to become shorter.

### ■ Precautions on handling the remote control

- The remote control may not be able to operate the front speaker unit when an object blocks the remote control sensor on the unit.
- Do not subject the remote control to impact. Do not allow it to get wet or place it in a location subject to high humidity.
- The remote control operations become difficult when direct sunlight or other strong light (such as from an inverter fluorescent lamp) strikes the sensor. Adjust the relative positions of the light and the front speaker if this happens.
- Remote control operations may not be possible if another remote control is being operated at the same time.

# NAMES OF ALL PARTS

## Front Speaker Unit (Front Panel)

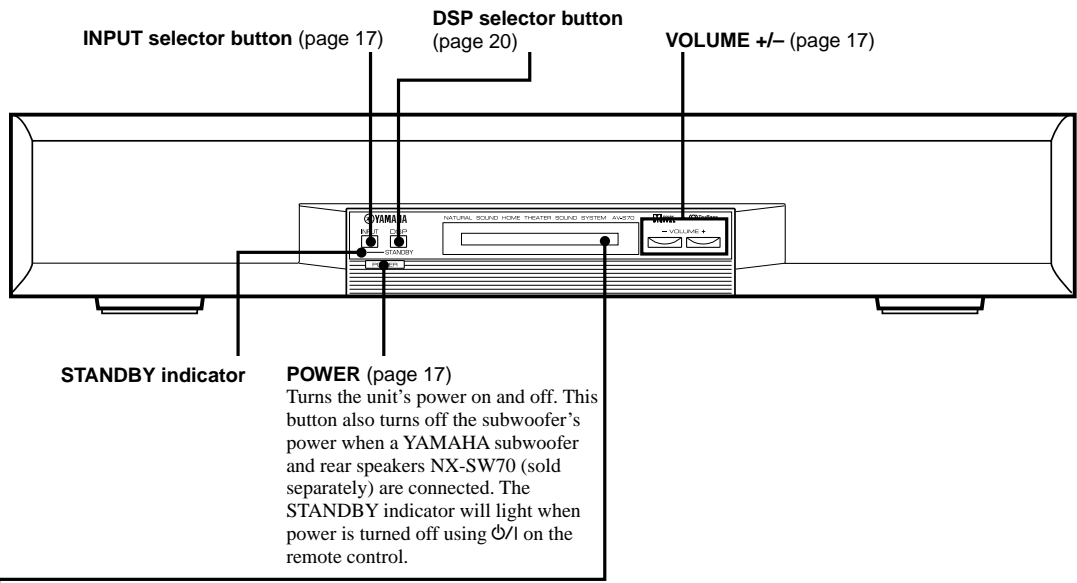

## Display

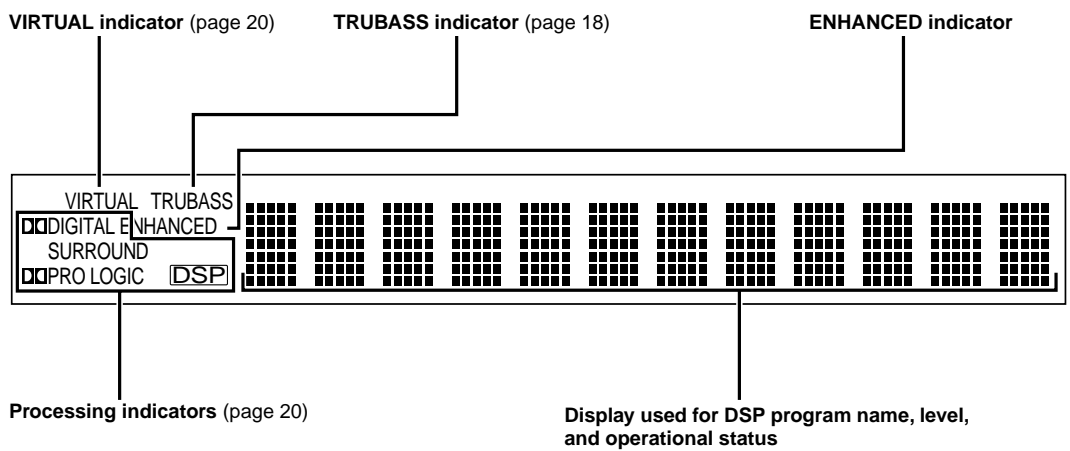

# Remote Control

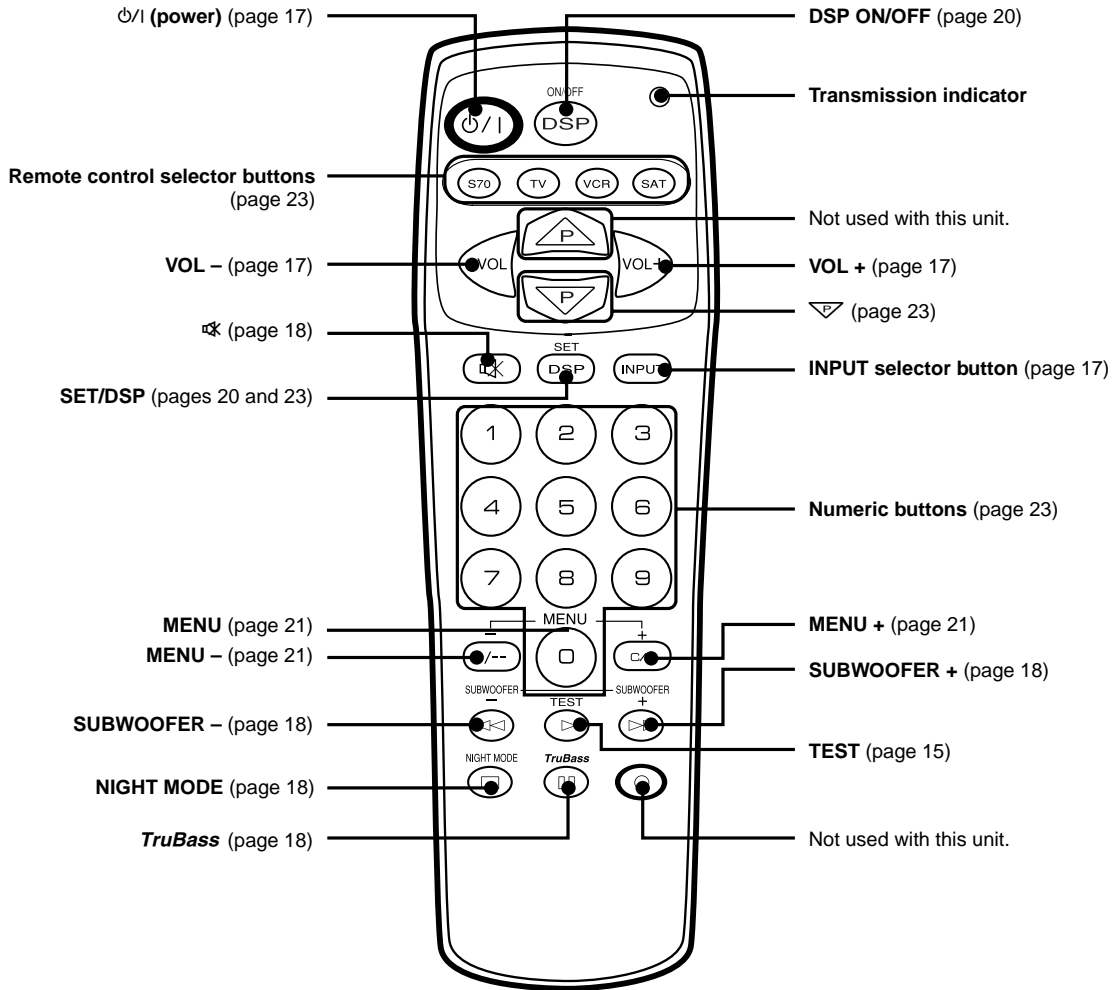

Of the buttons on the remote control, those used to control this unit is colored in dark gray.

# SPEAKER PLACEMENT

Although speakers should ideally be placed as shown below, satisfactory effects may be obtained even if you do not strictly follow these guidelines.

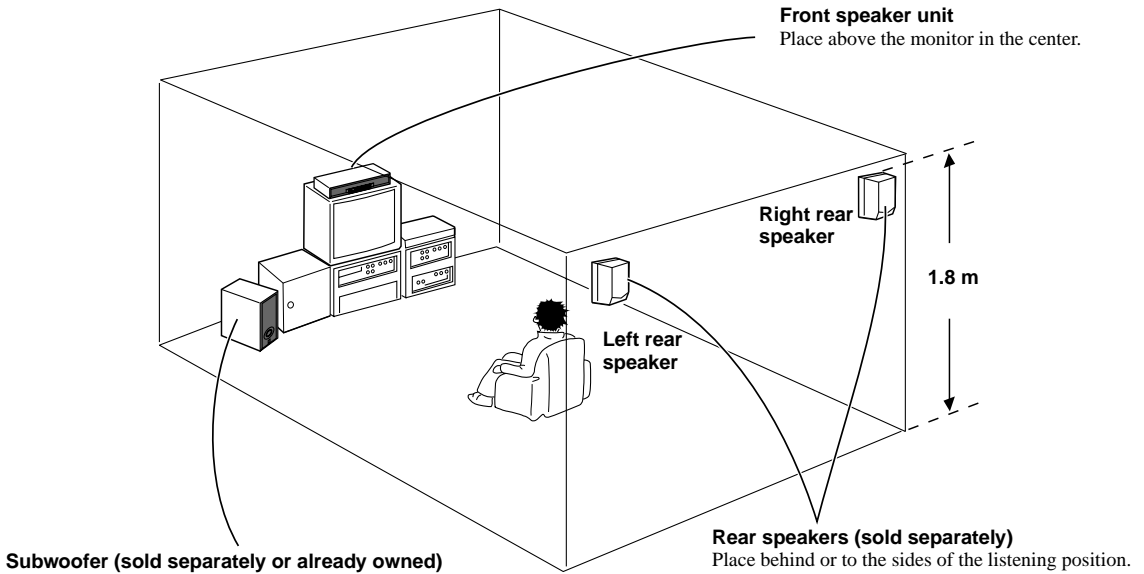

## ■ Front speaker unit

Place the front speaker unit on top of the television and align the front surface of the speakers with the front surface of the television monitor. For details on placement, refer to page 7. If the system cannot be placed on top of the television, place it on a rack beneath the television as close to the television monitor as possible.

## ■ YAMAHA rear speakers NX-AVS70 (sold separately)

Depending on room conditions, it is possible to place YAMAHA rear speakers NX-AVS70 on shelves or hang them on the wall. Speakers should be placed about 1.8 m above the floor.

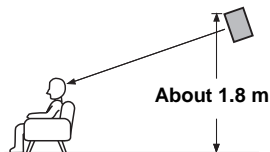

## ■ YAMAHA subwoofer SW-AVS70 (sold separately)

Place the subwoofer at the either right or left side of the front speaker unit and facing slightly toward the center of the room so that the sound from it and the sound reflected by the wall should not cancel out each other. Try altering the position of the subwoofer versus the listening position as the relative position will affect the way the bass sounds.

### CAUTION

Although the speakers in this unit are magnetically shielded, they may still affect the color on the television monitor when using the speakers on top of the television. Adjust the relative positions of the speakers and the television if this happens. Perform the following steps if you are using a magnetically shielded television.

- 1 Turn off the television.
- 2 Wait awhile and turn the television back on.



# INSTALLATION

To prevent the front speaker unit from falling, secure it with the provided velcro strip when placing it on a television or other device. Also, use the height adjustment bracket on the rear of the front speaker unit when there is not enough space for installation or when the surface is sloped.

## Using the Velcro Strips

### Precautions before installation

- Do not touch the adhesive surface after peeling off the strip as this will weaken its adhesive strength.
- Thoroughly wipe clean the surface where the velcro strip is to be applied. Note that adhesive strength is weakened if the surface is dusty, oily or wet and that this may cause the front speaker unit to drop.

- 1 Peel off the seal of the velcro strip with the rough surface and apply to the protrusions on the bottom of the front speaker unit.**

Wrap the strip tightly with sides of the tape well aligned with the edges of the protrusion.

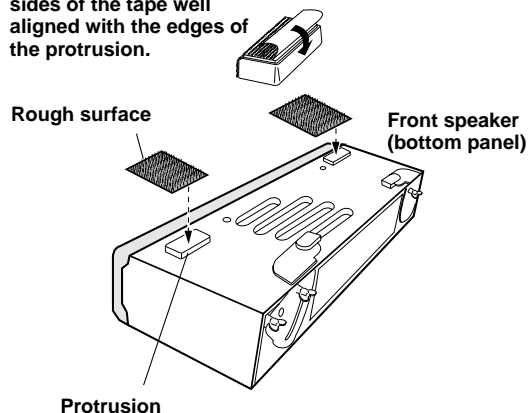

- 3 Peel off the seal of the velcro strip with the smooth surface and apply to the positions determined in step 2.**

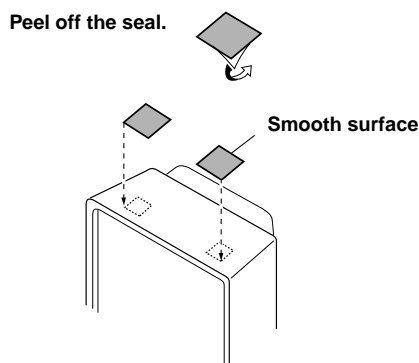

- 2 Place the front speaker unit where it is to be installed (ex. on top of the television ) to determine where to apply the velcro strip with the smooth surface.**

Position so that the position of the velcro strip stuck to the front speaker unit matches that of the velcro strip stuck to the top of the television.

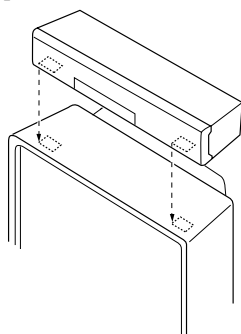

- 4 Align both the velcro strip on both sides and firmly press downward on the top of the front speaker unit.**

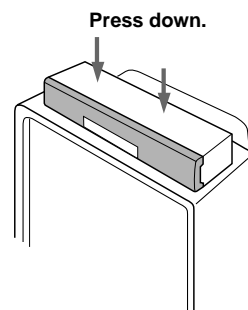

### Note

- Once the front speaker unit is secured in this way, the paint on the television surface used for installation may peel off when velcro strip is removed later. Be sure to apply velcro strip after carefully checking the surface to be used for installation.

## Using the Height Adjustment Brackets

- 1** Loosen the screws securing the adjustment bracket.

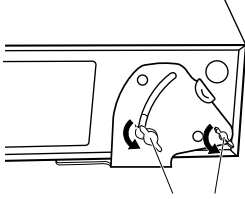

Loosen the screws.

- 2** Lower the bracket so that the front speaker unit is level and securely tighten the screws.

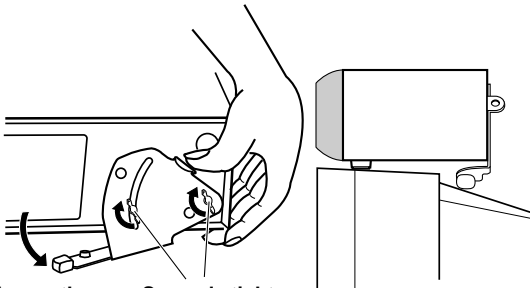

Lower the bracket and adjust.

Securely tighten the screws.

Place the front speaker unit so that it is level.

- To further stabilize and prevent falling

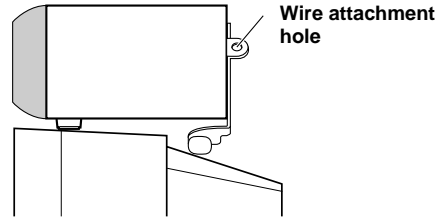

Secure the front speaker unit to the wall by attaching sufficiently strong wire to the wire attachment hole on the adjustment bracket. This prevents falling in two ways when this method is used together with velcro strip. This can prevent damage caused by the front speaker falling.

**Note**

- Please provide wire separately.

**CAUTION**

Never place anything on top of the front speaker unit.

# CONNECTIONS

## CAUTION

Always be sure to turn off the power of the main unit and any component to be connected when making connections.

### To ensure proper connections

- Connect the white plug of the connection cord to the left “L” (white) audio signal terminal and connect the red plug to the right “R”(red) terminal.
- Insert the plug securely. If the plug is not inserted securely, noise may result or sound may not be output.
- Since the method of connection and terminal names differ depending on the component being used, be sure to refer to the instruction manuals for all components being connected.
- After connections have been made, check one more time that wiring has been made properly.

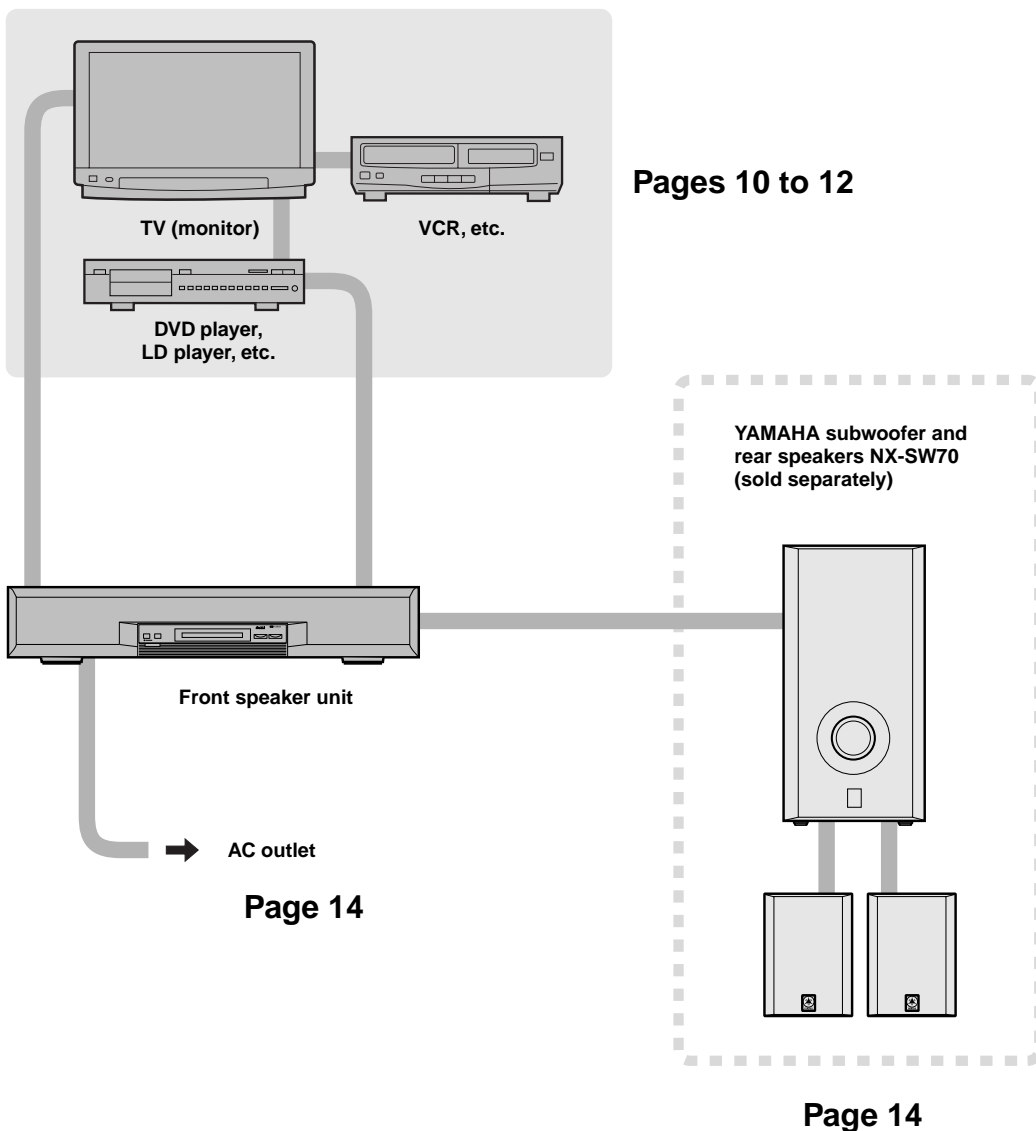

## Connecting a TV or VCR

### ■ Connecting a TV (monitor) with audio output terminals

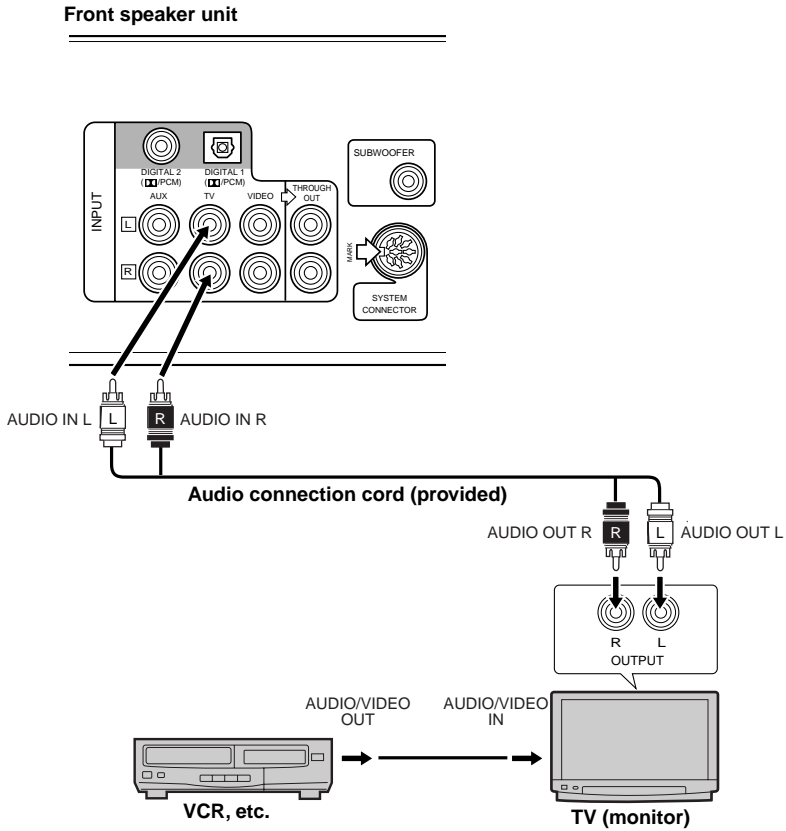

Connect the audio output terminal on the TV (monitor) to the TV terminal on the front speaker unit using the provided audio connection cord.



Television audio can be heard using the front speaker unit. (Although you can also hear the audio using the TV speakers, we recommend you reduce the TV volume so that you may enjoy the full benefit of the front speaker unit.) Audio can be heard using the TV speakers when the front speaker unit is turned off.

## ■ Connecting to a TV (monitor) without audio output terminals

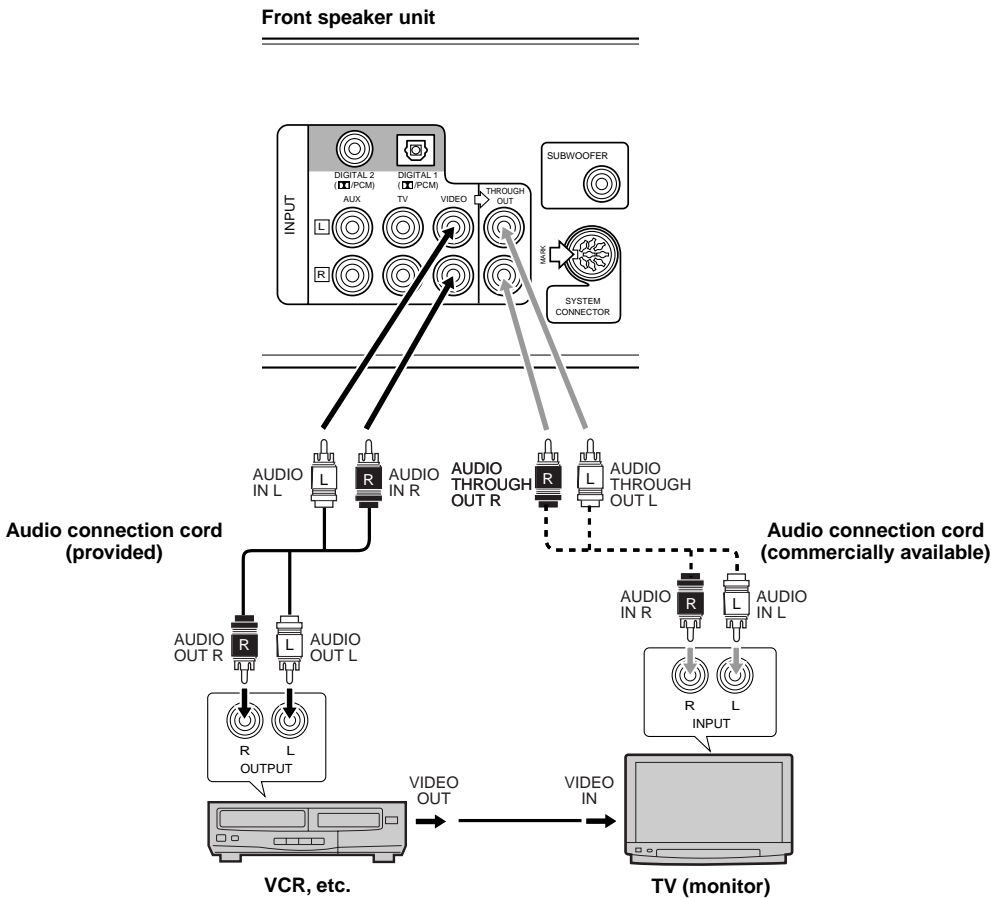

There are two methods of making connection:

1. connecting only the VIDEO terminals or
2. connecting the THROUGH OUT terminals in addition to the VIDEO terminals.

### When only the VIDEO terminals are connected

Connect the audio output terminals on the VCR to the VIDEO terminals on the front speaker unit using the provided audio connection cord. VCR audio may always be heard using the front speaker unit. Audio cannot be heard when the front speaker unit's power is turned off. (Audio cannot be heard from the TV's speakers either.)

### When VIDEO terminals and THROUGH OUT terminals are connected

Connect the THROUGH OUT terminals of the front speaker unit to the audio input terminals of the TV (monitor) using a commercially available audio connection cord. VCR audio can be heard using the front speaker unit when the front speaker unit is turned on. Audio can be heard using the TV speakers when the front speaker unit is turned off.

## ■ Connecting a TV (monitor) to enjoy digital audio

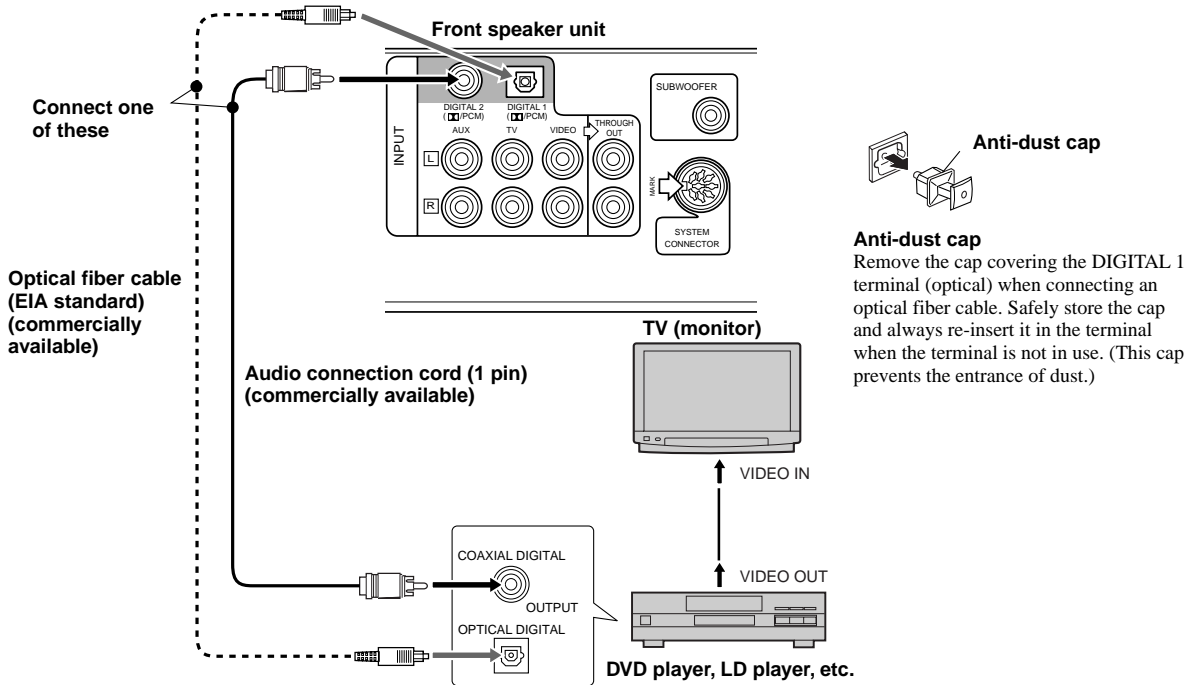

Connect the optical terminal or coaxial terminal of the LD or DVD player to the DIGITAL 1 (optical) terminal or DIGITAL 2 (coaxial) terminal of the front speaker unit using a commercially available optical fiber cable or audio connection cord (1 pin).

### Notes

- You need to make digital connection between this unit and your component to enjoy a Dolby Digital source.
- The audio of the LD or DVD player can be heard from the front speaker unit, but not from the TV speakers. The audio of the LD or DVD player cannot be heard when the front speaker unit's power is turned off.
- If your LD player has a Dolby Digital RF signal output terminal, be sure to use the RF demodulator (separately purchased).
- No sound will be heard when connecting your LD player's Dolby Digital RF signal output terminal directly to this unit's DIGITAL 2 terminal.

## Connecting a CD Player or MD Recorder

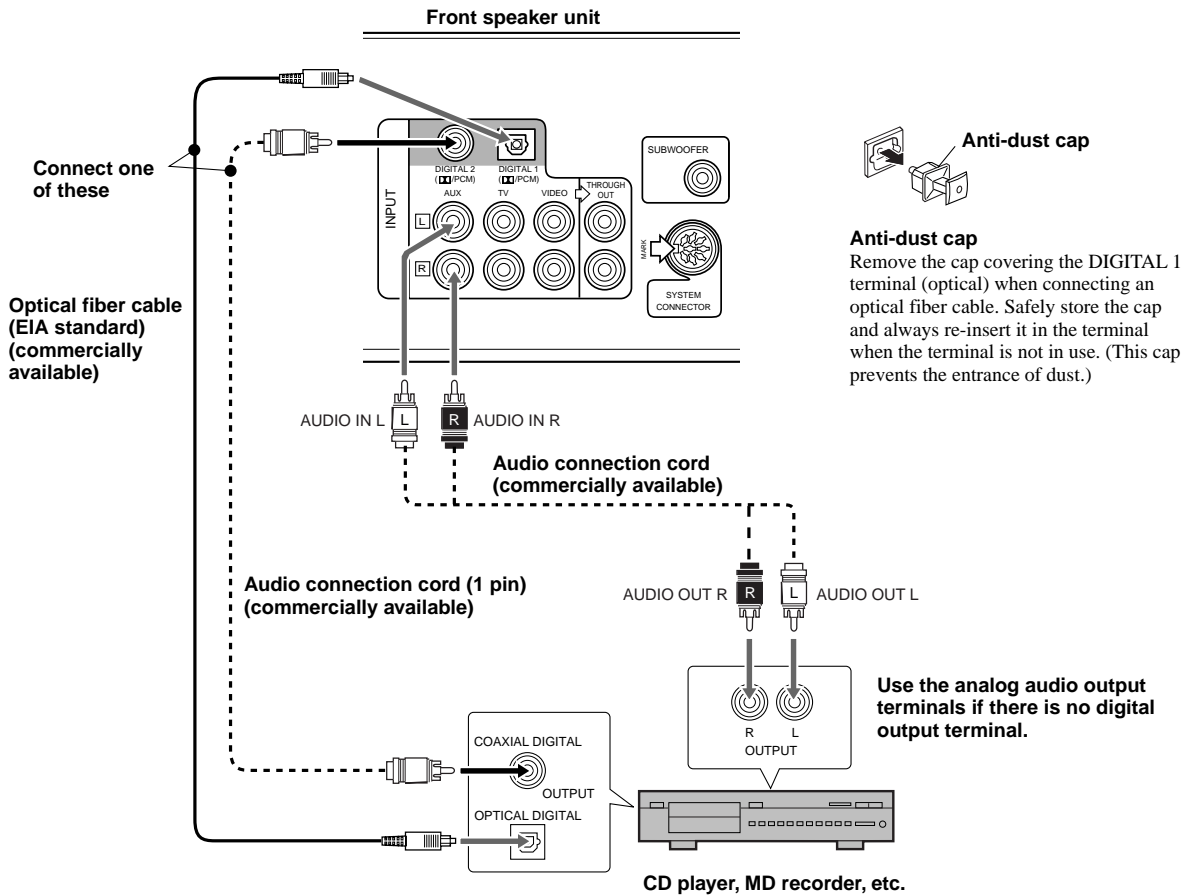

If the CD player or MD recorder has a digital output terminal, connect the optical or coaxial terminal on the CD player or MD recorder to the DIGITAL 1 (optical) terminal or DIGITAL 2 (coaxial) terminal on the front speaker unit using a commercially available optical fiber cable or audio connection cord (1 pin).

If there is no digital output terminal, connect the analog audio output terminals on the CD player or MD recorder to the AUX input terminals on the front speaker unit using a commercially available audio connection cord (2 pin).

## Connecting the Front Speaker Unit and the Subwoofer

Although the front speaker unit alone can be used to reproduce rich, natural sounding audio, the additional use of a subwoofer allows you to enjoy powerful bass tones.

Connecting a YAMAHA subwoofer and rear speakers NX-SW70 (sold separately) not only increases bass sensitivity but improves the surround effect as well.

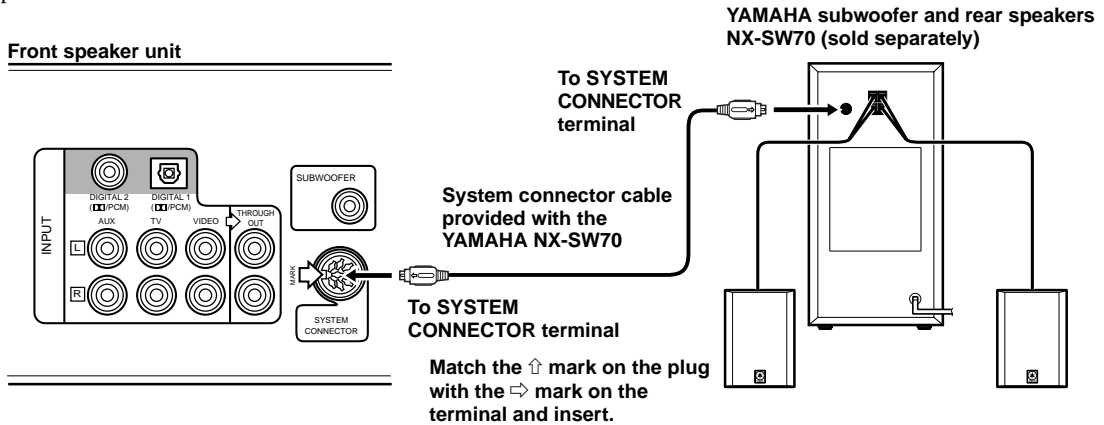

### Note

- Turning off the front speaker unit's power will also turn off the YAMAHA subwoofer SW-AVS70.



- When connecting your subwoofer, connect the input terminal on the subwoofer to the SUBWOOFER terminal on the front speaker unit using a commercially available audio connection cord (1 pin).
- For details regarding connections, please refer to the instruction manuals for your subwoofer or the owner's manual for the YAMAHA subwoofer and rear speakers NX-SW70 (sold separately).

## Connecting the AC Power Supply Cord

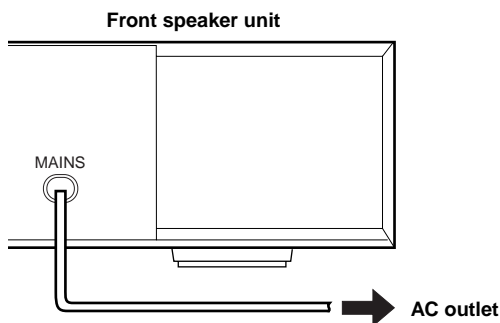

Once all connections have been made, check them one more time. Finally, insert the plug of the power supply cord for the front speaker unit into an AC outlet. Disconnect the power supply cord if you will not use the unit for an extended period.



# ADJUSTING THE SPEAKER OUTPUT LEVELS

When reproducing a Dolby Surround source using a DSP program such as DOLBY PRO LOGIC or DOLBY DIGITAL ENHANCED, it is necessary to adjust each channel to the same output level in order to bring out the full digital effect of these sound fields. Even when a different DSP program is used, it is possible to bring out the particular flavor of the sound field in question.

Speaker output levels may be adjusted by using the remote control before playback by following the steps.

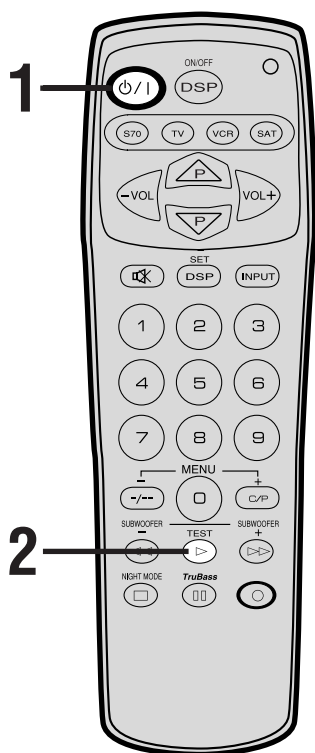

## 2 Press TEST.

Test tones (like pink noise) will be output in the following order.

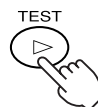

- When only the front speaker unit is being used or the VIRTUAL SURROUND DSP program is selected:

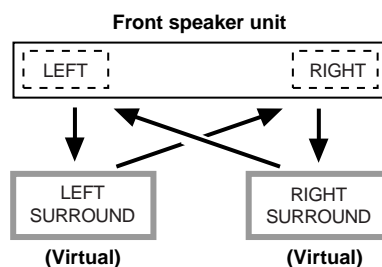

- When an NX-SW70 is connected:

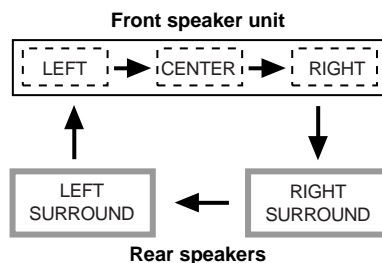

## 1 Press $\phi/I$ to turn on the power.



If the STANDBY indicator is lit, turn on the power using  $\phi/I$  on the remote control. If the main power is off (when the STANDBY indicator is not lit), turn on the power by pressing POWER on the front speaker unit.

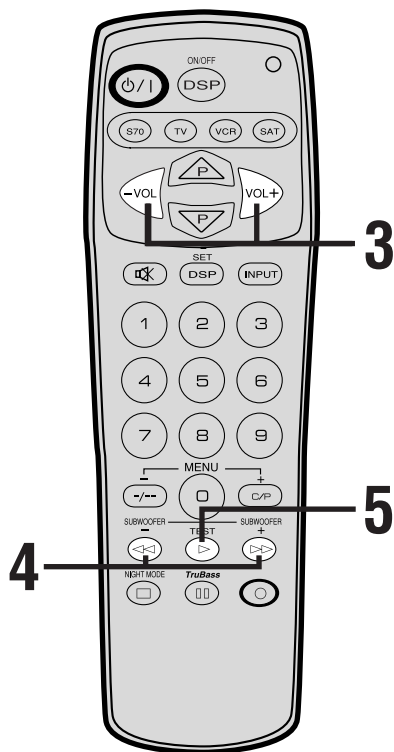

**3 Adjust the level of the test tone using VOL +/-.**  
(This sets the standard audio level you will be using.)

Pressing VOL + increases the level, while pressing VOL - decreases the level.

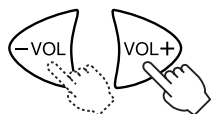

**4 Adjust the level of each channel while listening to the test tone.**

Pressing >> increases the level, while pressing << decreases the level.

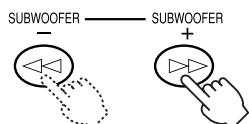

- If only the front speaker unit being used, be sure to adjust the level of the right and left rear virtual channels to match the level of the right and left main channels. (Rear virtual channels sound as if rear speakers are behind the listener.)
- If an NX-SW70 is connected, adjust so that the level of the center channel (built into the front speaker unit) and rear channels (NX-SW70 rear speakers) match the level of the right and left main channels (built into the front speaker unit).

**Notes**

- When an NX-SW70 is connected, you can adjust the center channel.
- If the right and left main channels have been adjusted, adjust the level of the center and right and left rear channels (or right and left rear virtual channels) one more time.
- The right and left rear virtual channels cannot be adjusted separately. Adjusting either of the virtual channels sets the other virtual channel to the same level.

**5 When the adjustment is complete, press TEST.**

A test tone will stop.

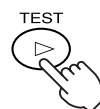

The level can be adjusted in the following range.

- When only the front speaker unit is being used or the VIRTUAL SURROUND DSP program is selected:
  - Right and left main channels: -10 to ±0 dB
  - Rear virtual channels: -3 to +3 dB
  - The minimum level for the main channel is -10 dB, while that for the rear virtual channels is -3 dB.
- When an NX-SW70 is connected:
  - Right and left main channels: -10 to ±0 dB
  - Center channel: -20 to +3 dB
  - Right and left rear channels: -20 to +6 dB
  - The minimum level for the main channel is -10 dB, while that for the rear channels is -20 dB.

# OPERATING THE UNIT

## Enjoying the Home Theater Sound System

This section describes how to select audio output from A/V component such as a TV, VCR, or DVD, LD, CD player, or MD recorder as input source to the Home Theater Sound System AV-S70 and how to adjust levels.

First turn on the playback component and the TV, and then follow the steps given below.

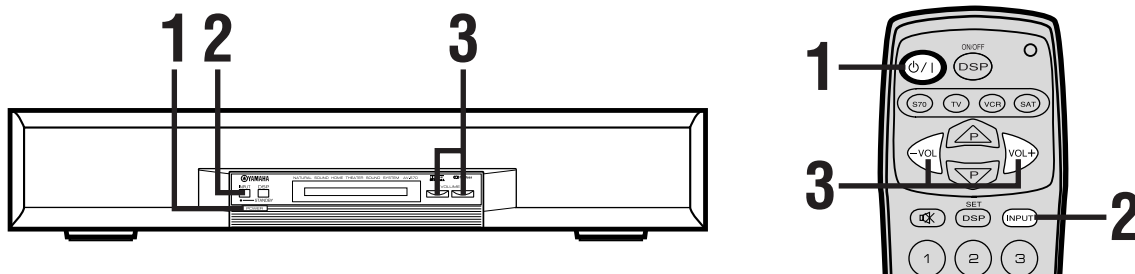

- 1 Press POWER (or  $\phi/|$  on the remote control) to turn on the power.**

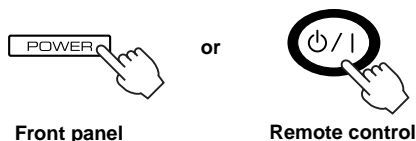

If the STANDBY indicator is lit, turn on the power using  $\phi/|$  on the remote control. If the main power is off (when the STANDBY indicator is not lit), turn on the power by pressing POWER on the front speaker unit.

- 2 Press the INPUT selector button.**

Each time the button is pressed, the input source will be switched in the order: VIDEO  $\rightarrow$  TV  $\rightarrow$  AUX  $\rightarrow$  DIGITAL 1  $\rightarrow$  DIGITAL 2.

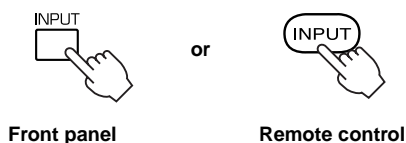

- 3 Adjust the level using VOLUME +/- (or VOL +/- on the remote control).**

Pressing VOLUME + (or VOL + on the remote control) increases the level, while pressing VOLUME - (or VOL - on the remote control) decreases the level.

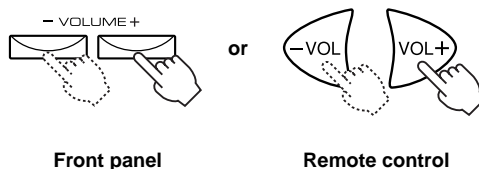

# USING CONVENIENT FUNCTIONS

You can use convenient functions with the remote control during audio reproduction.

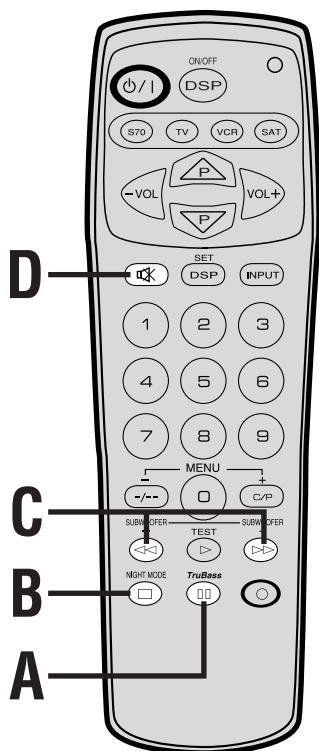

## A Increasing the power of the mid-range

Press **TruBass**.

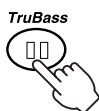

- The TRUBASS\* indicator will light in the display.
- This will increase the level of the mid-range, giving more force to dialog and song lyrics.

To cancel TRUBASS mode, press **TruBass** again.

\*  **TruBass**

TruBass and the  symbol are trademarks of SRS Labs, Inc. in the United States and selected foreign countries. TruBass technology is incorporated under license from SRS Labs, Inc.

## B Listening to music clearly at low levels

Press **NIGHT MODE**.



- Sounds will be clear.
- Use this function when it is difficult to output high volumes such as late at night.

To cancel NIGHT MODE, press NIGHT MODE again.

### Note

- Volume cannot be decreased using this button. To decrease the volume, press VOLUME – (or VOL – on the remote control).

## C Adjusting the subwoofer level

Subwoofer level can be adjusted if a subwoofer is connected.

Pressing **SUBWOOFER +** increases the level, while pressing **SUBWOOFER –** decreases the level.

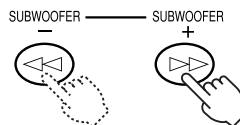

The level can be adjusted within the range –20 dB to +10 dB.

## D Temporarily reducing the audio

Press .

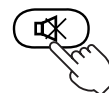

“Mute ON” is displayed while audio is reduced.

To return to the original volume level, press  again.

# DSP PROGRAM (DIGITAL SOUND FIELD PROCESSOR EFFECT)

You can recreate the sound and feel of a movie theater, concert hall or other location by selecting from any of seven DSP programs best suited to the source being reproduced. This allows you to enjoy the full experience of digital systems such as DOLBY DIGITAL, DOLBY PRO LOGIC, or YAMAHA CINEMA DSP.

## Description of DSP Programs

### ■ When only the front speaker unit is connected

No.	Program name	Features and applicable sources
1	<b>VIRTUAL SURROUND</b> (input source: Dolby Digital or Dolby Surround)	For enjoying the virtual surround field created using Dolby Digital or Dolby Pro Logic when using a front speaker unit.
7	<b>MONO MOVIE</b>	For old monaural movies.

### ■ When the front speaker unit and a YAMAHA subwoofer and rear speakers NX-SW70 (sold separately) are connected

No.	Program name	Features and applicable sources
1	<b>VIRTUAL SURROUND</b> (input source: Dolby Digital or Dolby Surround)	For enjoying the virtual surround field created using Dolby Digital or Dolby Pro Logic when using a front speaker unit.
2	<b>DOLBY DIGITAL</b> (input source: Dolby Digital) <b>DOLBY PRO LOGIC</b>	For the straightforward reproduction of movie sound as accurately processed using a Dolby Digital or Dolby Pro Logic decoder.
3	<b>DOLBY DIGITAL ENHANCED</b> (input source: Dolby Digital) <b>DOLBY PRO LOGIC ENHANCED</b>	For adding sound field effects through digital signal processing of the Dolby Digital or Dolby Surround signal.
4	<b>DIGITAL MOVIE THEATER</b> (input source: Dolby Digital) <b>70 mm MOVIE THEATER</b>	For reproduction of the rich, full sound found in a movie theater using the latest movie sound design in which dialog and sound effects are handled separately.
5	<b>CONCERT</b>	For reproduction of the type of classical concert hall atmosphere. This sound field is optimally suited for the reproduction of operas and other classical pieces.
6	<b>SPORTS</b>	For the wide area sound field effect of a variety show or live broadcast program. Resonant sounds are restrained so there is not much variation even when this sound field is used for an extended period of time.
7	<b>MONO MOVIE</b>	For old monaural movies. Sound field effects and moderate resonance processing are used to bring fuller life to the monaural audio.

## Enjoying DSP Programs

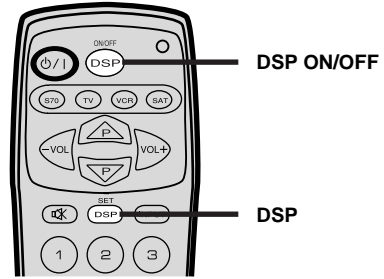
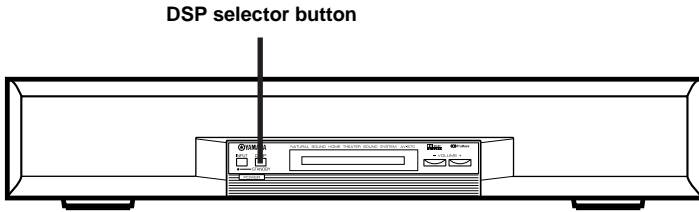

Press the DSP selector button (on the front speaker unit) or DSP (on the remote control).

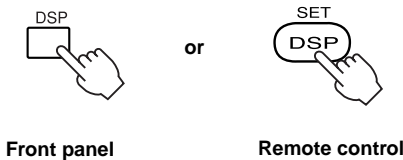

Each time this button is pressed, the DSP program will be selected in the following order and the currently selected DSP program name will be displayed.

● **When only the front speaker unit is connected:**

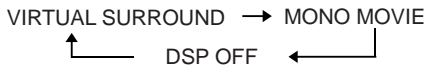

● **When the front speaker unit and a YAMAHA subwoofer and rear speakers NX-SW70 are connected:**

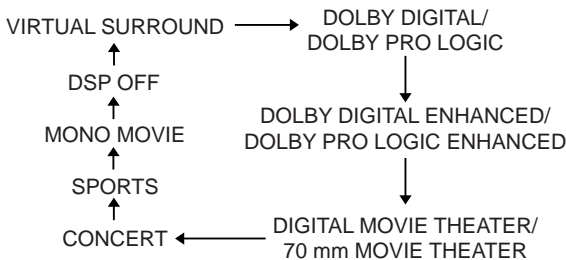

**Notes**

- The option “DSP OFF” only appears when using the DSP selector button on the front speaker unit.
- Be sure to select the DSP program best suited for the atmosphere of the source being listened to.
- The last DSP program used for each input source (AUX, TV, VIDEO, DIGITAL 1, and DIGITAL 2) is stored in memory so that the DSP program is automatically selected when the input source is selected.

■ **To cancel sound field effects (using the remote control)**

**Press DSP ON/OFF.**

Ordinary stereo reproduction will result and “DSP OFF” will be displayed when the sound field effect is canceled. Pressing this button again will cause the sound field effect to return.

■ **Processing indicators**

A processing indicator will light to show with the type of input signal when reproducing a source using a DSP program.

**DIGITAL:** Lights when reproducing a source encoded with Dolby Digital other than 2-channel.

**VIRTUAL and SURROUND:** Lights when using VIRTUAL SURROUND DSP program.

**PRO LOGIC:** Lights when reproducing a source encoded with Dolby Digital 2-channel, PCM or an analog source using DSP program No. 2 or 3.

**DSP:** Lights when reproducing a source using DSP program No. 3 through 7.

**Notes**

- The VIRTUAL SURROUND, DOLBY DIGITAL/DOLBY PRO LOGIC, DOLBY DIGITAL ENHANCED/DOLBY PRO LOGIC ENHANCED, DIGITAL MOVIE THEATER/70 mm MOVIE THEATER DSP programs are optimum for reproducing visual software encoded with Dolby Digital that displays the or logo marks.
- The volume level of the right and left main channels may differ based on the input source being used because, except in the case of Dolby Digital, sound field data as actually measured are used.
- Select the DSP program that you feel sounds best for a source regardless of its name.



- Be sure to minimize the volume level of the TV to maximize the virtual surround effect when reproducing a source with the VIRTUAL SURROUND program.
- Refer to the glossary on page 28.

# MENU FUNCTIONS

The menu functions include: “Auto Power” for setting automatic power on/off, “Dimmer” for adjusting display brightness, “Input Name” for naming input, and “Delay Time” for adjusting the delay time used for surround sound.

Adjustments on the menu functions should be performed with the remote control.

Each time MENU on the remote control is pressed, the function displayed will cycle in the order: “Auto Power”, “Dimmer”, “Input Name”, “Delay Time” (only appears when the selected DSP program is DOLBY DIGITAL/ DOLBY PRO LOGIC, or DOLBY DIGITAL ENHANCED/ DOLBY PRO LOGIC ENHANCED), and input display.

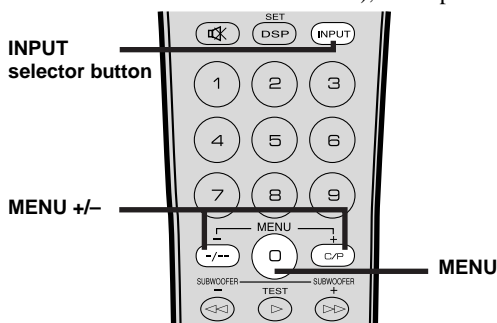

## Setting Auto Power On/Off

Auto Power functions as described below.

1. No input signal and no buttons have been operated for 30 minutes.
2. Auto Power Off automatically shuts off the power. (The STANDBY indicator will slowly flash.)
3. If a signal is input, Auto Power On automatically turns the power on. (Or power can be turned on again using  $\odot/I$  on the remote control.)

You can set sensitivity for the Auto Power function or turn the Auto Power function off completely.

- 1 Press MENU to display “Auto Power”.**

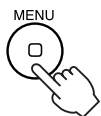

- 2 To set Auto Power On, use the MENU + or - to select the “Auto Power 2”. To set Auto Power Off, use the MENU - to select the “OFF”.**

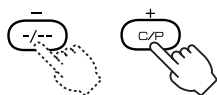

The Auto Power function may not function properly depending on the signal output level of connected component. In this case, you can refer to the table given below to change the sensitivity of the Auto Power function.

Pressing + will cycle through the selections from top to bottom, while pressing - will cycle through the selections from bottom to top.

Display	Setting/Symptom
OFF	Do not use the Auto Power function.
1	When Auto Power On does not function even though a signal arrives or when Auto Power Off results even though there is a continuing signal.
2	Ordinary setting when using the Auto Power function.
3	When Auto Power On results even though no signal has arrived, or when Auto Power Off does not result even though there is no current signal.

To cancel the menu functions, press MENU until the input display returns.

## Adjusting Display Brightness

The display brightness of the front speaker unit can be adjusted as follows.

- 1 Press MENU to display “Dimmer”.**

The currently brightness level (such as “Dimmer:  $\pm 0$ ”) will be displayed.

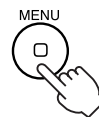

- 2 Press MENU + or - to adjust the brightness.**

Pressing + will brighten the display, while pressing - will dim the display. Brightness can be adjusted from -3 (dimtest) to +3 (brightest).

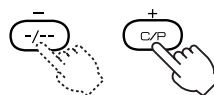

To cancel the menu functions, press MENU until the input display returns.

## Naming Input

It is possible to give names to the AUX, DIGITAL 1 and DIGITAL 2 input terminals. (It is not possible to change the input names for the TV or VIDEO input terminals.)

This function makes selecting input source easier by allowing you to give a name that quickly allows you to see which component is connected to the terminal in question. For example, if an MD recorder is connected to the AUX, you can name that source “MD”, or if a DVD player is connected to the DIGITAL 1 terminal, you can name that source “DVD”.

**1 Press MENU to display “Input Name”.**

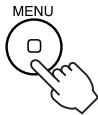

**2 Press the INPUT selector button and select the input you want to name (AUX, DIGITAL 1 or DIGITAL 2).**

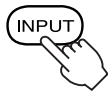

**3 Press MENU + or – to select the name.**

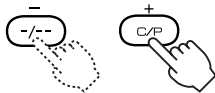

If you select AUX under step 2 above, names will be displayed in the following order when you press +.

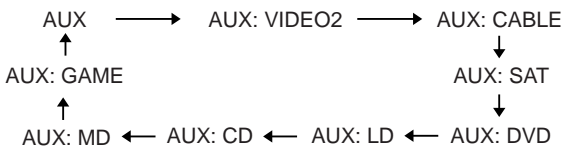

If you select DIGITAL 1 or 2 under step 2 above, names will be displayed in the following order when you press +.

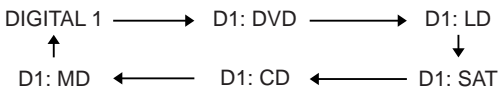

### Notes

- “D1:” is displayed before the name when DIGITAL 1 has been selected, while “D2:” is displayed before the name when DIGITAL 2 has been selected.
- Pressing – displays the names in reverse order.

**4 You can repeat steps 1 through 3 to give names to AUX, DIGITAL 1 and DIGITAL 2 input terminals.**

To cancel the menu functions, press MENU until the input display returns.

## Adjusting the Delay Time

When the selected DSP program is DOLBY DIGITAL/ DOLBY PRO LOGIC or DOLBY DIGITAL ENHANCED/ DOLBY PRO LOGIC ENHANCED, it is possible to adjust the delay time. The delay time is that time difference between when the main channel sound can be heard and the surround sound can be heard. Although it is possible to set the delay time separately for Dolby Digital and Dolby Surround input, if the Dolby Digital (or Dolby Surround) delay time is adjusted, the level for Dolby Surround (or Dolby Digital) will also be raised or lowered accordingly.

Setting a longer delay time makes the sound field feel larger, while setting a shorter delay time makes it feel smaller.

**1 Press MENU to display “Delay Time”.**

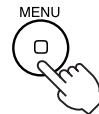

**2 Press MENU + or – to adjust the delay time.**

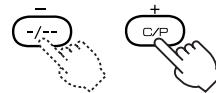

- Adjustable range
  - For Dolby Digital input: 0 to +15 ms
  - For Dolby Surround input: 15 to 30 ms

To cancel the menu functions, press MENU until the input display returns.

### CAUTION

The variable sound intensity range is large in the case of CDs and MDs. Listening for an extended period of time at or near maximum volume to music that includes sudden changes from soft to loud noises may damage the speakers.



# OPERATING OTHER COMPONENTS USING THE REMOTE CONTROL

Setting the manufacturer code for your TV, VCR or satellite tuner/cable TV on the remote control allows you to operate the front speaker unit and your TV, VCR or satellite tuner/cable TV by remote control. Note that there are two methods for setting the code: manual preset and auto preset.

## Notes

- Remote control of some component may not be possible depending on the model and the year of make even though its manufacturer is listed on page i (at the end of this manual).
- Depending on the model in question, some component from other manufacturers cannot be controlled, or only limited functions can be controlled, even though the proper manufacturer code has been set. If you encounter this problem, please use the remote control supplied with the component in question.
- Setting the manufacturer code can not be performed if your component to be controlled does not support remote control operation.

## Setting the Manufacturer Code

### ■ Using manual preset

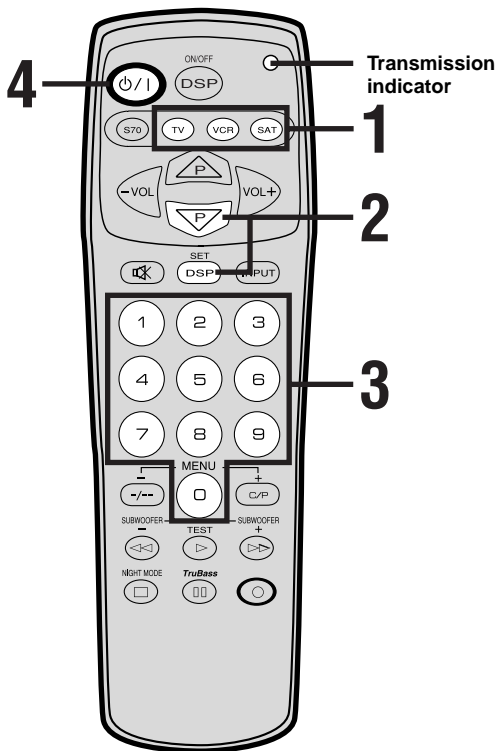

- 1** Press the remote control selector button (TV, VCR or SAT) for which the manufacturer code is to be set.

The signals for controlling the front speaker unit have already been set for the S70 button so that only the manufacturer code for the TV, VCR or SAT needs to be set. A manufacturer code can be set for a single button if necessary.



- 2** Hold down SET and press until the transmission indicator lights.

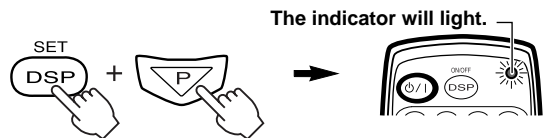

- 3** While the transmission indicator is lit, use the numeric buttons to enter the 4-digit manufacturer code for the component to be controlled.

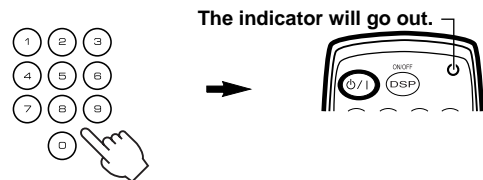

The transmission indicator will go out, the code has been set properly. (The code has not been set properly if the indicator flashes and then goes out.)

Refer to page i at the end of this manual for a list of manufacturer codes.

- 4** Press and check that the component to be controlled turns on and off.



■ Using auto preset

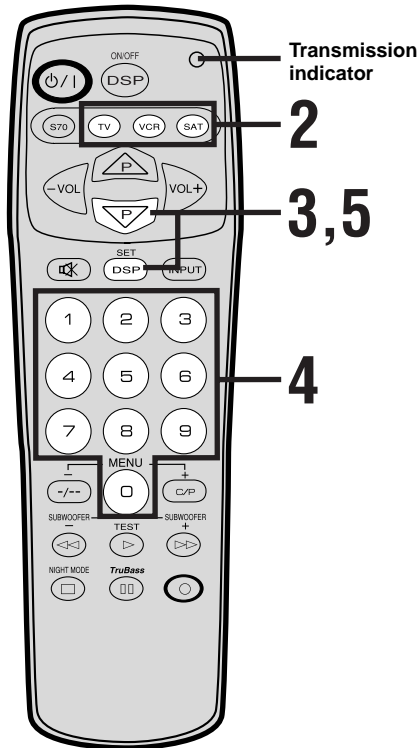

**1** Turn on the power of the component (TV, VCR or satellite tuner/cable TV) to be controlled by the remote control.

**2** Press the remote control selector button corresponding to the component for which auto preset is to be performed. (Press “TV” for TV, “VCR” for VCR, and “SAT” for satellite tuner/cable TV.)

The signals for controlling the front speaker unit have already been set for the S70 button so that only the manufacturer code for the TV, VCR or SAT needs to be set. A manufacturer code can be set for a single button if necessary.



**3** Hold down SET and press  $\nabla$  until the transmission indicator lights.

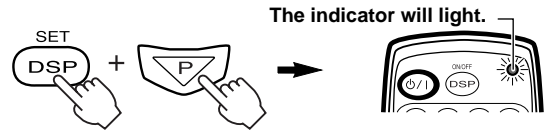

**4** While the transmission indicator is lit, using the numeric buttons, if you selected “TV” under step 2, enter “0001”; if you selected “VCR”, enter “0002”; and if you selected “SAT”, enter “0003” for satellite tuner or “0004” for cable TV.

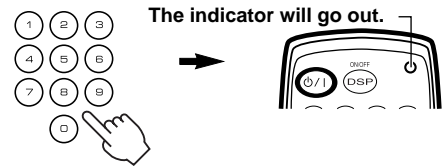

**5** Hold down SET and press  $\nabla$  until the transmission indicator lights.

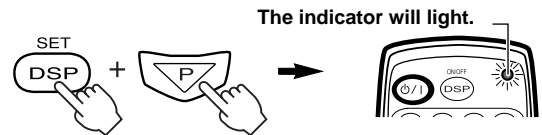

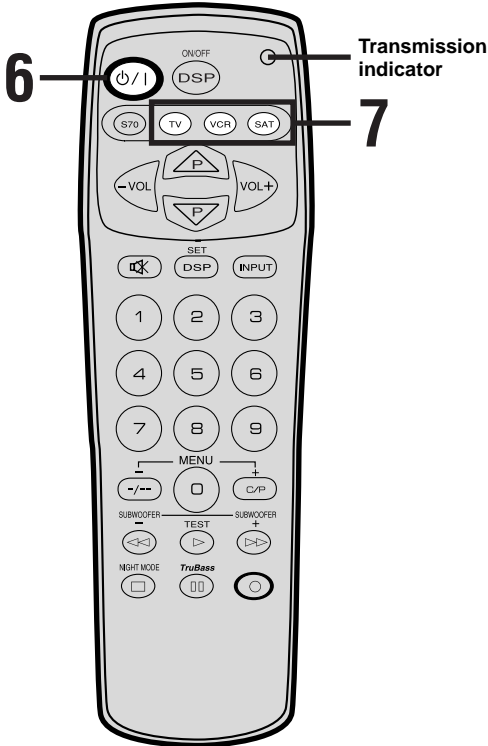

**7** Press the remote control selector button you pressed in step 2.

The indicator will go out.

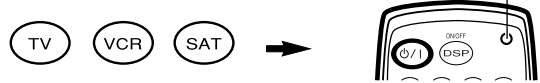

The transmission indicator will go out once auto preset has been performed properly.

**Note**

- During step 6, if you press ⏻/⏻ about 300 times and the transmission indicator flashes twice slowly and the component's power still has not turned off, this indicates that auto preset cannot be performed for the component in question. Check that the component to be controlled supports remote control operation. You may also try performing manual preset.

**■ Precautions when performing preset**

The transmission indicator will go out once the manufacturer code has been set properly.

If the transmission indicator does not go out, or if it flashes and then goes out, repeat the procedure from step 1. Pay attention to the following points when you repeat the preset procedure.

- Check the manufacturer code number.
- Check that the correct remote control selector button has been selected when setting the manufacturer code.
- If more than one code is given for a manufacturer, try entering each code in the order given.
- Remove and replace the remote control's batteries (complete this step within 2 minutes) and then repeat the procedure.

**■ To clear a manufacturer code**

Perform the procedure "Using manual preset" described on page 23 and enter the following codes when you reach step 3.

- To clear the "TV" button: 0000
- To clear the "VCR" button: 0000
- To clear the "SAT" button: 0000
- To clear all buttons for "TV", "VCR" and "SAT": 9990

**6** Point the remote control at the component to be controlled (the component turned on in step 1) and press ⏻/⏻ repeatedly until the component's power turns off.



If the transmission indicator flashes twice, this indicates that you have cycled through all the codes stored in the memory of the remote control. Up to 300 manufacturer codes (for TV) may be stored in the memory of the remote control. Since a manufacturer code is set by pressing ⏻/⏻ and cycling in order through these codes, you may need to press ⏻/⏻ up to 300 times to reach the proper code.



Up to 120 manufacturer codes for VCR, 170 for satellite tuner and 20 for cable TV may be stored in the memory of the remote control.

**Note**

- If you accidentally press ⏻/⏻ too many times after the power is turned off, you may press 🔊 the same number of times to go through the manufacturer codes in reverse order. The correct manufacturer code will not be set unless you do this.

## Controlling a TV

You can control your TV by setting the corresponding manufacturer code for the remote control selector button "TV".

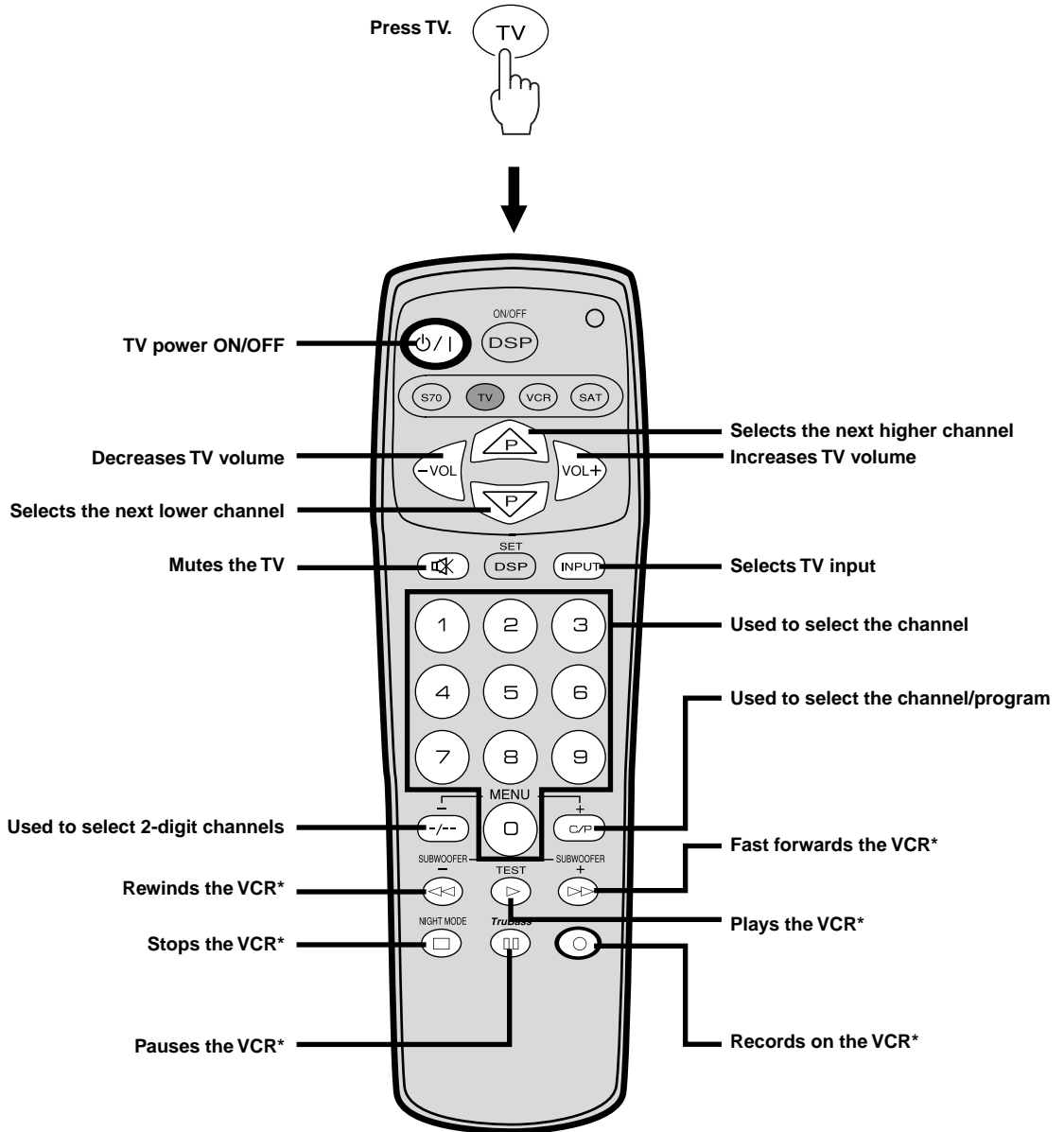

A VCR can be controlled using \* marked buttons once the manufacturer code for that VCR has been set for the remote control selector button "VCR".

## Controlling a VCR

You can control your VCR by setting the corresponding manufacturer code for the remote control selector button "VCR".

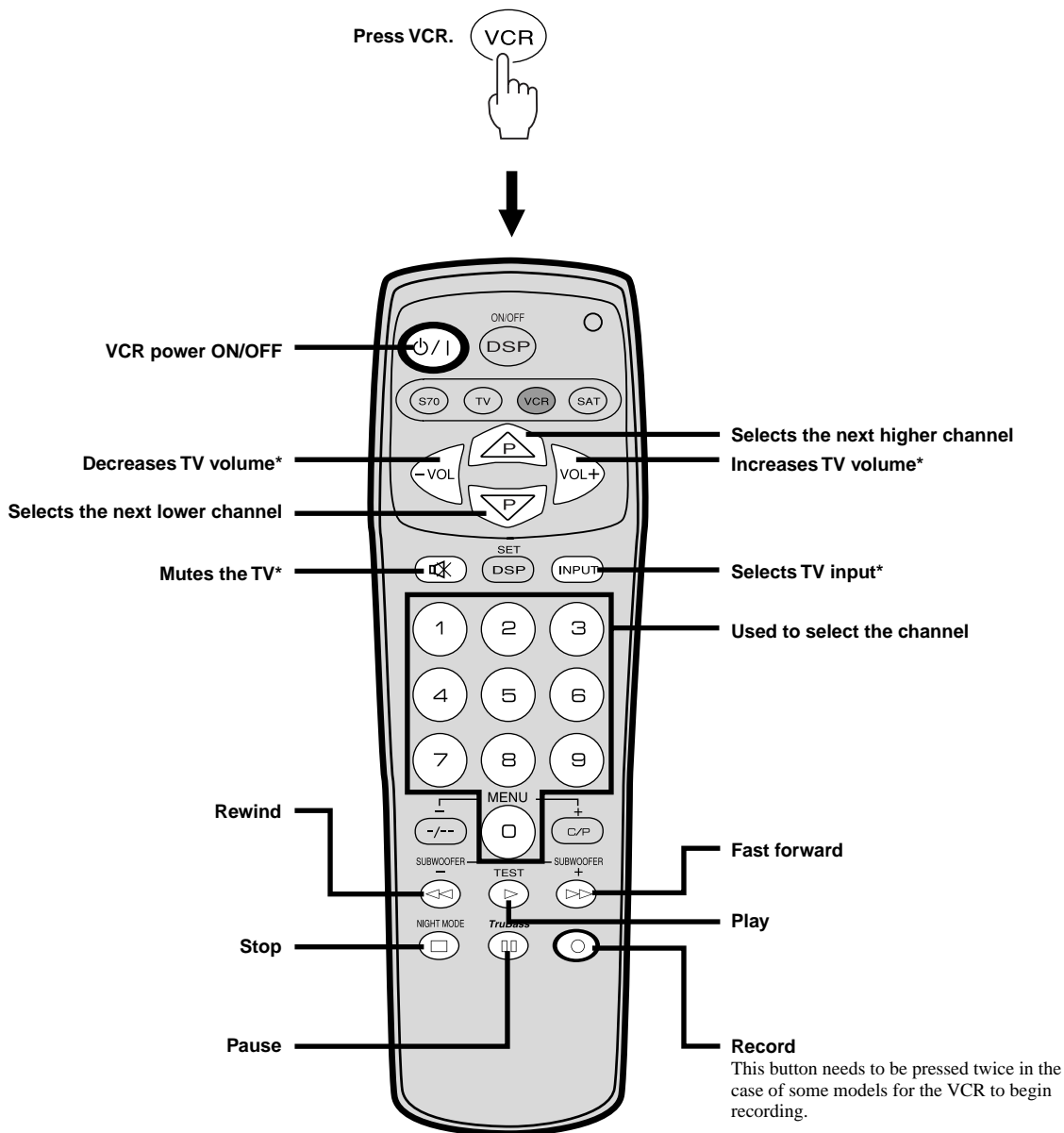

A TV can be controlled using \* marked buttons once the manufacturer code for that TV has been set for the remote control select button "TV".

# GLOSSARY

## ■ Encode/Decode

When a signal or other information is processed, compressed and digitized, this is called encoding. Encoding can be used to record an extremely large amount of information on a single CD or DVD.

An encoded signal cannot be listened to directly. It must be returned to its original state (i.e. audible sound) and this is called decoding.

## ■ Sound field

Not all sound travels from the sound source directly into the human ear, but instead reflects off of walls, ceilings and other objects to arrive at the ear slightly delayed (early reflection). It may also reflect repeatedly in a complicated manner before reaching the ear (subsequent reverberation). A human is able to perceive the size and shape of a location based on the various sounds heard in this way. The specific acoustic space of a particular building is called a sound field.

## ■ Dolby Surround

In movie theaters and in live theaters, the spectators are surrounded by many speakers and sound effects geared to each scene are used to make sound move from front to back and right to left. This gives the sound a three dimensional feel that surrounds the entire body. Dolby Surround is used to implement this realistic effect. Originally, the Dolby Surround system consisted of a total of four channels: two front channels (right and left), one center channel, and one rear channel. Later, two-channel stereo compatibility was added to for broadcast and video media used in the home. The ability to easily set up a home AV system capable of stereo reproduction is one of the biggest features of Dolby Surround.

## ■ Dolby Digital

Dolby Digital consists of a total of five channels: three front channels and two rear channels, plus a distinct LFE channel for low frequency effect. It is therefore commonly referred to as a 5.1 channel system. Using digital compression technology for all 5.1 channels, Dolby Digital can be used for completely independent audio reproduction. Dolby Digital offers superior sound quality and a more three dimensional surround effect in comparison to the older Dolby Surround, which mixes four channels (three front and one rear) into two-channel stereo and separates them using a matrix circuit.

## ■ Virtual surround

We basically perceive the direction from which sounds come to us based on the difference in time they reach the right and left ears and differences in sound level. Virtual technology is based on this property of the human ear. A DSP (digital sound field processor — a form of digital signal processing) and right and left front speakers are used so that the listener feels like he or she is hearing sounds that come from virtual speakers located in directions other than just the two physical speakers. This allows the listener to experience surround effects as if rear speakers were present as in a five-speaker system.

## ■ YAMAHA DSP (Digital Sound Field Processor)

YAMAHA technicians traveled to world famous concert halls, opera houses and other locations just to measure acoustical information such as the direction, intensity, band characteristics, and delay time of reflected sounds. This wealth of information was then put on a ROM.

Using a built-in YAMAHA DSP (digital sound field processor) to create sound fields, this front speaker unit allows you to freely select various sound field programs created from this actual acoustical data so that you can reproduce the sound field of famous halls and live houses right in your listening room.

Movie makers design sounds for a movie so that the sound and screen become one. Dialog is positioned right on the screen, sound effects behind the screen, music behind that, and surround effects wrap around the audience.

CINEMA DSP is a program for use in AV reproduction that has evolved from YAMAHA DSP. Fusing the movie sound decoders, Dolby Pro Logic and Dolby Digital, with YAMAHA DSP, allows you to reproduce the type of surround sound field of the quality found on a dubbing stage designed to optimize movie surround conditions. (A dubbing stage is the final mix used to complete the final sound design for a movie.)

By adding YAMAHA DSP processing to both the right and left front channels and the center channel, the CINEMA DSP program wraps the audience in a surround sound field that not only makes dialog real, but penetrates and surrounds the screen to give depth to sound effects and music as well as a smooth sense of movement to sound sources.

# TROUBLESHOOTING

Be sure to investigate thoroughly before requesting repairs or after service. If it cannot be corrected, or if the problem is not listed in the SYMPTOM column, disconnect the power cord and contact your authorized YAMAHA dealer or service center.

## Notes

- Sometimes the unit may cease to recognize operations due to a mistaken operation or as a result of strong external noise (such as irregular voltage due to shock of impact, excessive static electricity, or lightning strike). If this happens, first disconnect the power cord, wait about 30 seconds, re-connect the power cord, and try the desired operation again.
- When requesting repairs or after service of the YAMAHA subwoofer and rear speakers NX-SW70 (sold separately), be sure to bring along with this unit.

## ■ General

SYMPTOM	CHECK	Refer to page
<b>No sound output at all.</b>	• Is the AC power supply cord connected?	14
	• Is the TV or VCR connected correctly?	10 – 12
	• Is the input source selected correctly?	17
	• Has this unit's audio temporarily been lowered?	18
<b>A "humming" noise is present.</b>	• Hum caused by external electromagnetic waves may be generated. Try inverting the right-left polarity of the power cord and re-insert into the AC outlet.	14
<b>The STANDBY indicator flashes slowly.</b>	• The unit is in Auto Power Off mode. Turn off the main power if the unit is not to be used for an extended period of time.	21
<b>There is noise in the tuner or TV and the video image is unstable.</b>	• Is a tuner or TV that uses an indoor antenna located near the unit? Use of an outdoor antenna is recommended.	—

## ■ When using a DSP program

SYMPTOM	CHECK	Refer to page
<b>Movie dialog and other audio is difficult to hear.</b>	• Are you using one of the DSP programs CONCERT or SPORTS? Select the other program.	19, 20

## ■ When using the remote control

SYMPTOM	CHECK	Refer to page
<b>The remote control does not function properly.</b>	• Are the batteries used up?	3
	• Is the remote control pointed at the sensor?	3
	• Is the remote control too far from or too close to the sensor?	3
	• Is direct sunlight or other intense light (such as an inverter fluorescent lamp) striking the sensor?	3
	• Is another remote control being used at the same time?	3
	• Have the batteries been inserted in the correct direction?	2
	• Has the remote control selector button "S70" been pressed? Press "S70" when you want to control this unit after controlling another component.	—
<b>Cannot control other component.</b>	• Has the correct manufacturer code been set?	23
	• Has the remote control selector button corresponding to the component to be controlled been pressed?	26, 27

# SPECIFICATIONS

## Amplifier Section

Rated Output	
Front .....	30 W + 30 W (1 kHz, 10% THD, 6 ohms)
Signal-to-Noise Ratio .....	85 dB (AUX, IHF-A)
Total Harmonic Distortion	
.....	0.08% (Input: AUX, 1 kHz, 12.5 W/6 ohms)
Input Sensitivity/Impedance .....	AUX, 200 mV/50 k-ohms

## Speaker Section

Front Speakers	
Type .....	Bass reflex
Speakers .....	8-cm cone x 2, magnetically shielded
Maximum Input Power .....	30 W x 2
Impedance .....	6 ohms

## General

Power Supply .....	AC 230 V, 50 Hz
Power Consumption .....	68 W
Dimensions (W x H x D) .....	600 x 110 x 243 mm
Weight .....	7.0 kg
Accessories .....	Remote control
.....	UM-4 batteries (x 4)
.....	Audio connection cable (2 pin, 3 m)
.....	Connection guide
.....	Velcro strips (two sets)

Specifications are subject to change without notice.



# INDEX

## A

Adjusting display brightness .....	21
Adjusting the bass (subwoofer level) .....	18
Adjusting the delay time .....	22
Adjusting the volume level .....	17
Automatically setting a manufacturer code .....	24
Auto Power → Setting auto power on/off .....	21
AUX terminal .....	13

## C

CINEMA DSP → DSP program .....	19
Connecting a CD player .....	13
Connecting a DVD player .....	12
Connecting a subwoofer and rear speakers .....	14
Connecting a TV .....	10, 11
Connecting a VCR .....	10, 11
Connecting an LD player .....	12
Connecting an MD recorder .....	13
Connecting the AC power supply cord .....	14
Controlling a TV with the remote control .....	26
Controlling a VCR with the remote control .....	27

## D

Delay time → Adjusting the delay time .....	22
DIGITAL input terminal .....	12, 13
Dimmer → Adjusting display brightness .....	21
Display .....	4
DOLBY DIGITAL, DOLBY PRO LOGIC .....	19, 20
DSP programs .....	19

## I

Input Name → Naming input .....	22
---------------------------------	----

## M

Manually setting a manufacturer code .....	23
Manufacturer codes .....	i (at the end of this manual)
Menu functions .....	21

## N

Naming input .....	22
NIGHT MODE .....	18

## R

Reducing the audio .....	18
--------------------------	----

## S

Selecting a sound field .....	20
Selecting input .....	17
Speaker placement .....	6

## T

Test tone .....	15
THROUGH OUT terminal .....	11
TRUBASS mode .....	18

## U

Using the height adjustment bracket .....	8
Using velcro strips .....	7

## V

VIRTUAL SURROUND .....	19, 20
------------------------	--------

## W

Wire installation (to prevent falling) .....	8
--	---

**LIST OF MANUFACTURER'S CODES  
LISTES DES CODES FABRICANT  
VERZEICHNIS DER HERSTELLERCODES  
LISTA ÖVER TILLVERKARKODER  
ELENCO DEI CODICI DEL FABBRICANTE  
LISTA DE CÓDIGOS DE FABRICANTES  
LIJST VAN CODES VAN FABRIKANT**

<b>TV</b>		CGE	0491, 0811, 0981, 1401, 1531, 1611, 1621, 1981, 2201, 2251, 2271	FIDELITY(UK)	0561, 0591, 1931, 2281	GRUNDIG	0221, 0231, 0471, 0491, 0711, 0741, 1381, 2021, 2041, 2141, 2151
ADMIRAL	0411, 0451, 0911, 1021, 1081			FILMNET	1141		
AIKO	0891	CITIZEN	0791	FINLANDIA	0451, 2321	HANSEATIC	0021, 0121, 0141, 0431, 0591, 1561
AKAI	0061, 0101, 0231, 1191, 1351, 1591, 1641, 1791, 1891, 1981	CLARIVOX	0821, 0961, 1971	FINLUX	0021, 0261, 0491, 0521, 0781, 0811, 0871, 1081, 1411, 1421, 1981, 2051, 2091, 2121, 2151, 2551	HANTAREX	0581
AKURA	1331	CLATRONIC	1181, 1331			HEMMERMANN	0061
ALBA	1241, 1331, 2361	CONCERTO	0791	FIRST LINE	1511, 1981	HIFIVOX	0331, 0571
ALBIRAL	1971	CONDOR	0761	FISHER	0021, 0091, 0141, 0511, 0601, 0801, 0821, 0981, 1021, 1081, 1981, 2091	HINARI	0071, 0141, 0451, 1261, 1351, 1511, 1641, 1981, 2011
AMSTRAD	1301, 1511	CONTEC	0151, 1171			HITACHI	0001, 0011, 0031, 0081, 0141, 0291, 0331, 0341, 0451, 0601, 0631, 0701, 1281, 1561, 1601, 1821, 1831, 1841, 1861, 1871, 1881, 1891, 1941, 1981, 2051, 2321, 2341
ANAM	1171	CONTINENTAL EDISON	0571, 0651, 0901	FORGESTONE	2281	HYPER	0591, 0601, 1511, 1621
ARC EN CIEL	0571	CRAIG	1171	FORMENTI	0451, 0491, 0761, 1081, 1451, 1541, 1981	IMPERIAL	0451, 0491, 0811, 0981, 1401, 1611, 1621, 2201, 2251, 2271
ARCAM	0571, 0761	CROSLEY	0021, 0491, 1021, 1081, 1401, 1981, 2201, 2251, 2271	FORMENTI-PHOENIX	0021, 0431, 0451, 0591, 1411	INGERSOL	1511
ARISTONA	0751	CROWN	2541	FORTRESS	1081	INNO HIT	0581, 0601, 0841, 1101, 1331, 1371, 1511, 2011
ARTHUR MARTIN	0451, 1641	CTC CLATRONIC	0261	FRONTECH	0451, 1181, 1981	INNOVATION	2591, 2601, 2611, 2621, 2641, 2651, 2661, 2711, 2721, 2761, 2771, 2781
ASA	0411, 0451, 0521, 0781, 0871, 1021, 1081, 1421, 2051, 2091, 2151, 2551	CXC	1171	FUJITSU	1261	INTERFUNK	0031, 0041, 0061, 0121, 0181, 0451, 0491, 1081, 1641, 1791, 1821, 1981, 2231
		DAEWOO	0101, 1501, 1511, 2611	FUNAI	0391, 0691, 1171, 1181, 1261	IRRADIO	0491, 1321, 1331, 1371, 1411, 1511, 2011
ASTRA	1511	DANSAI	0101	FUTURETECH	1171	ISUKAI	1331
ATANTIC	0761	DECCA	0271, 0581, 0601, 0971, 1101, 1691	GBC	0021, 0141, 1321, 1511, 1621, 1981	ITT	0031, 0041, 0051, 0061, 0071, 0081, 0181, 0411, 0451, 0491, 1241, 1291, 1351, 1501, 1601, 1641, 1741, 1921, 1981, 2091, 2331, 2431
ATLANTIC	0761	DECCA(UK)	0271, 0581, 0601, 1101, 1681	GEC	0451, 1101, 1281, 2321	ITT-NOKIA	0031, 0041, 0051, 0061, 0071, 0081, 0181, 0411, 0451, 0491, 1241, 1291, 1351, 1501, 1601, 1641, 1741, 1921, 1981, 2091, 2331, 2431
ATORI	1511	DEGRAAF	0451, 1351	GEC(UK)	0031, 0081, 0581, 0601, 1101, 1281, 1561		
AUDIOSONIC	1181, 1321, 1411	DIXI	0991, 1511	GELOSO	0021, 0411, 0451, 1321, 1511, 1621, 1981		
AUSIND	0491, 1411	DOMEOS	0101	GENERAL TECHNIC	2681		
AUTOVOX	0091, 0351, 0481, 0491, 0601, 0781, 0951, 1051, 1081, 1391, 1421	DORIC	1031	GENEXXA	0451, 1331		
		DUAL	0091, 0601, 1611, 1641, 2101	GOLDSTAR	0591, 0601, 0761, 0791, 1371, 1491, 1511, 1561, 1621, 1641		
BAIRD	1101, 1351	DUAL-TEC	0601, 1511, 1621, 2111	GRANADA	0141, 0451, 0491, 0581, 0601, 1101, 1111, 1351, 1981, 2321		
BANG & OLUFSEN	1081	DUMONT	0261, 0521, 0781, 1021, 1081, 1981, 2121, 2151	GRANADA(UK)	0081, 0141, 0451, 0491, 0581, 0601, 1031, 1311, 1521, 1561, 1641		
BASIC LINE	1321, 1331	DYNATRON	0101				
BAUER	1451	ELBE	1551, 1971, 2031				
BAUR	0041, 0061, 0121, 0131, 0221, 1561	ELECTRO TECH	1511				
BEKO	2491, 2501	ELEKTRONSKA	0771				
BLAUPUNKT	0221, 0231, 0241, 0251, 0471, 0741, 2201, 2211, 2221, 2231, 2241, 2261, 2571, 2581	ELMAN	0261, 1621				
		ELTA	1511				
BRANDT	0571, 0651, 0731, 0901, 1821	ELTA	1511				
		EMERSON	0921, 1021, 1081, 1121, 1171, 1261, 1301				
BRIGMTON	1321, 1511	ERRES	0101				
BRIONVEGA	1021, 1051, 1081	ETRON	1981				
BRITANNIA	0761	EUROPHON	0261, 0581, 0601, 0771, 1091, 1621, 2001				
BRUNS	0821, 0991, 1021, 1081	FENNER	0101, 1511				
BSR	0391, 0691, 1621, 1901, 1981	FERGUSON	0281, 0371, 0551, 0651, 0781, 0861, 0881, 1131, 1181, 1361, 1461, 1971, 1991, 2281, 2311, 2341				
BUSH	0451, 1241, 1331, 1641, 1741, 2131, 2151	FIDELITY	0451, 0761, 2281				
BUSH(UK)	0481, 1561, 1611						
CANDLE	0791						
CENTURY	1021, 1081						

JVC	0071, 0721, 1441, 1581, 1591, 1741, 1791	MINERVA	0221, 0231, 0491, 1381, 2141, 2151	PAUZA	1511	SAMSUNG	0101, 0601, 0841, 0981, 1101, 1181, 1371, 1511, 2011, 2841
KAISUI	0591, 1321, 1331	MISTRAL	2281	PERDIO	0891, 1101		
KAMOSONIC	0601	MITSUBISHI	0141, 0201, 0231, 0661, 1191, 1201, 1231, 1671, 1691, 1741	PHILCO	0021, 0491, 0811, 0981, 1021, 1081, 1401, 1611, 1621, 1751, 2201, 2251, 2271, 2451, 2471	SANYO	0141, 0151, 0401, 0601, 0801, 0821, 0981, 1021, 1101, 1111, 1291, 1351, 1691, 1741, 2051, 2091, 2551
KARCHER	0591, 0601, 0841, 1091, 1321, 1511, 1561, 2051	MIVAR	0491, 0501, 0581, 0591, 0761, 0771, 1371, 1431, 2031, 2801, 2811, 2831	PHILIPS	0101, 0361, 0591, 0621, 0681, 0751, 0761, 1021, 1081, 1281, 2031, 2281, 2291, 2431, 2441, 2511, 2731		
KAWASHO	0761	MTC	0791			SBR	0681, 0751, 1281, 2281
KENDO	0261	MULTITECH	0261, 0581, 0601, 0641, 0981, 1321, 1511	PHOENIX	1081	SCHAUB LORENZ	0451
KENNEDY	0021, 0351, 0951, 1981	MURPHY	0451, 2091	PHONOLA	0751, 1081	SCHNEIDER	0021, 0071, 0091, 0451, 0511, 0591, 0601, 0751, 1321, 1361, 1621, 1641, 2101, 2111, 2291
KNEISSEL	2911	MURPHY(UK)	0081, 1031	PIONEER	0291, 0451, 1341, 1821		
KONKA	2701	N.E.I.	0101, 0961	PRANDONI-PRINCE	0411, 0451, 0491, 0581, 1411	SCOTT	1171, 1261
KORTING	0431, 1011, 1021, 1081, 1541	NAD	1341	PRANDONI-PROMCE	0451, 0491, 0581	SEG	0261, 0601, 0821, 0991
KTV	0601, 1171	NEC	0141, 1721, 1731	PRIMA	0451	SEI	0641, 0691, 1081, 1301, 1481, 1981
LENOIR	0601, 1511	NECKERMANN	0451, 0601, 0981, 1081, 1561, 1931, 1981, 2211, 2231, 2241	PROFEX	1981	SELECO	0071, 0101, 0351, 0411, 0451, 0951, 1901, 2061, 2101, 2111
LEYEO	1181	NEDIATOR	0101	PROTECH	0641, 1181, 1981	SENTRA	1601
LIFETEC	2591, 2601, 2611, 2621, 2641, 2651, 2661, 2671, 2681, 2691, 2711, 2761, 2771, 2781	NICAMAGIC	0761	QUELLE	0041, 0061, 0121, 0221, 0231, 0391, 0491, 0521, 0601, 0781, 1371, 1381, 1411, 1421, 1641, 1681, 2051, 2091, 2141, 2151, 2201, 2211, 2231, 2241, 2251, 2271, 2551, 2571, 2581	SHARP	0141, 0151, 0191, 1761, 1781
LOEWE OPTA	0121, 0131, 0581, 0611, 1081	NIKKAI	1101, 1331, 1641, 1701, 2011	RADIOMARELLI	0101, 0451, 0661, 0771, 1081	SIAREM	0021, 0261, 0581, 0641, 1021, 1081, 1981
LOGIC	1691, 2281	NOBLIKO	0261, 0491, 0591, 0641, 1381, 1411	RADIONETTE	0031, 2051, 2091	SICATEL	1971
LOGIK	0551, 1681, 2281	NOGAMATIC	0571	RADIOLA	2291	SIEMENS	0151, 0221, 0231, 0451, 0741, 2011, 2201, 2211, 2221, 2231, 2241, 2261, 2571, 2581
LOWEWE	0831	NOKIA	0031, 0041, 0051, 0061, 0071, 0081, 0181, 0411, 0451, 0491, 1241, 1291, 1351, 1501, 1601, 1641, 1741, 1921, 1981, 2091, 2331, 2431, 2461, 2791	RANK	0481, 2151	SILVER	1181
LUMA	0351, 0451, 1901	NORDMENDE	0451, 0531, 0541, 0571, 1051, 1131	RBM	2131, 2151	SINGER	0021, 0261, 1021, 1081
LUXMAN	0791	NORDMENDE	1591, 1791, 1811, 1821, 1891, 1941, 2631	RBM(UK)	0481	SINUDYNE	0101, 0021, 0061, 0261, 0391, 0641, 0691, 0851, 0941, 1021, 1081, 1241, 1301, 1321, 1481, 1631, 1981
LUXMAN STEREO TUNER	0791	OCEANIC	0321, 1651, 1981	REDIFFUSION	0451, 0661, 1641, 1981, 2331		
LUXOR	0001, 0061, 0181, 0341, 0421, 0451, 0461, 0491, 0601, 0671, 1351, 1371, 1561, 1601, 1911, 1921, 1981	OCEANIC(F)	0031, 0061, 0321, 0441, 1661	REDIFFUSION(UK)	0061, 0081, 1031	SONOKO	1181, 1511, 0101
LYCO	1181	ONCEAS	0601	REX	0071, 0101, 0351, 0411, 0451, 0951, 1901, 2061, 2101, 2111	SONY	0141, 0171, 1121, 1681, 1691, 2751, 2821
MAGNADYNE	0021, 0061, 0261, 0581, 0641, 0771, 1021, 1081, 1621, 1981	ONWA	1171	RFT	0991, 2511	SOUNDESIGN	1171
MAGNAFON	0261, 0491, 0581, 0591, 0641, 0761, 1091, 2001	ORION	0061, 0391, 0691, 0851, 1211, 1241, 1251, 1301, 1481, 1511, 1681, 1691, 1981, 2371, 2421	ROADSTAR	1321, 1511	SSS	1171
MAGNUM	2851, 2871, 2881, 2891, 2901	OSAKA	2011	ROTEL	0151	STERN	0071, 0101, 0351, 0411, 0451, 0951, 1901, 2061, 2101, 2111
MANESTH	0101	OSAKI	1101, 1331, 2011	SABA	0291, 0331, 0421, 0451, 0531, 0541, 0571, 0581, 0651, 0731, 0931, 1021, 1071, 1081, 1131, 1791, 1811, 1821, 1891, 1941, 2631	SUNKAI	0691
MARANTZ	0101	OSUME	0151	SACCS	1971	SUPRA	0791
MARELLI	1081	OTTO VERSAND	0021, 0121, 0141, 0221, 0601, 1561, 1741, 1981	SAISHO	0451, 0601, 1161, 1241, 1301, 1511, 1671, 1681, 1691	TANDBERG	0161, 0331, 0611, 1021, 1421, 1771, 1791, 2081
MARK	0101	PAEL	0591, 1411	SALORA	0011, 0041, 0061, 0071, 0341, 0451, 0671, 1291, 1351, 1521, 1561, 1601, 1641, 1911, 1921, 1931, 1981, 2321	TANDY	0451, 0191, 1331, 1531
MATSUI	0061, 0451, 0601, 0691, 1101, 1151, 1241, 1271, 1301, 1511, 1561, 1681, 1691	PANASONIC	0031, 0201, 0211, 0451, 0701, 1311, 1751, 1961, 2561, 2741			TASHIKO	0141
MAXIMAL	0071, 1981	PANORAMIC	2351			TATUNG	0271, 0581, 0601, 0971, 1101, 1681, 1691
MCMICHAEL	1281	PATHE MARCONI	0571	SAMBERS	0261, 0491, 0581, 0641, 1091, 1371, 1411, 2001	TCM	2621, 2641, 2711, 2761, 2771, 2781
MEDION	2591, 2601, 2611, 2621, 2641, 2651, 2661, 2671, 2681, 2691, 2711, 2721, 2761, 2771, 2781	PATHE' CINEMA(F)	0431, 0591, 1621, 1661, 1971			TECHNICS	1311
MEMOREX	1511	PAUSA	1511				
METRO	2851, 2861						
METZ	0231, 0741, 1001, 1041, 1081, 1481, 2071, 2081						
MGA	1231						
MICROMAXX	2591, 2621, 2641, 2651, 2711, 2761, 2771, 2781						

TECHWOOD	0791	<b>VCR</b>		GRANADA(UK)	0052, 0092, 0462, 0602, 0812, 0822	NOKIA	0022, 0032, 0042, 0072, 0292, 0492, 0532, 0572, 0762, 1152
TEKNIKA	1171, 1231, 1261	AIWA	0042, 0352, 0432	GRUNDIG	0052, 0062, 0092, 0232, 0252, 0262, 0752, 0802	NORDMENDE	0042, 0102, 0142, 0192, 0222, 0242, 0392, 0402, 0632, 0732, 0742, 0762, 0782, 0792, 0832, 0842, 0872
TELE	1141	AKAI	0042, 0422, 0492, 0582, 0612, 0642, 0652, 0762, 0912	HANSEATIC	0052, 0812	OLYMPUS	0462
TELEAVIA	0571, 0651, 0731, 1821	ALBA	0002, 0112, 0282, 0332, 0342, 0972	HARMAN/KARDON	0122, 0922	OPTONICA	0132, 0502
TELEFUNKEN	0291, 0301, 0311, 0551, 0731, 1131, 1471, 1591, 1791, 1801, 1811, 1821, 1991, 2161, 2171, 2181, 2191, 2201, 2251, 2271, 2521, 2631	AMSTRAD	0322, 0432, 0452	HCM	0002	ORION	0162, 0202, 0312, 0442, 0512, 0522, 0982
TELETECH	1511	ANITECH	0002	HINARI	0002, 0202, 0412, 0442, 0522	OSAKA	0432
TEMPEST	2381, 2391, 2401, 2411	ANITSCH	1002	HITACHI	0042, 0172, 0292, 0432, 0602, 0662, 0812, 1022	OSAKI	0002, 0012, 0432
TENSAI	1331, 2091	ASA	0012, 0052	IMPERIAL	0072, 0432	OTTO VERSAND	0052, 0062, 0812
TEXET	0601	AUDIOSONIC	0002	INGERSOL	0442	PANASONIC	0022, 0212, 0462, 0672, 0992, 1092, 1102, 1182
THOMSON	0331, 0481, 0531, 0571, 0631, 0651, 0731, 0901, 1241, 1571, 1591, 1791, 1811, 1821, 1891, 1941, 2531	BAIRD	0042, 0282, 0492	INNO HIT	0002, 0052, 0072	PENTAX	0172, 0602
THORN	0741, 0861, 2091, 2251, 2271, 2281	BANG & OLUFSEN	0042	INNOVATION	1142, 1162, 1172	PERDIO	0432
THORN-FERGUSON	0281, 0371, 0551, 0651, 0781, 0861, 0881, 1131, 1181, 1361, 1461, 1971, 1991, 2281	BAUR	0052, 0062, 0812	INTERFUNK	0022, 0052	PHILCO	1062
TMK	0141, 0791, 1471	BLAUPUNKT	0062, 0092, 0252, 0462, 0672, 0992	IRRADIO	0002, 0012	PHILIPS	0052, 0082, 0092, 0152, 0182, 0362, 0372, 0382, 0472, 0502, 1072
TOSHIBA	0141, 0381, 0481, 1221, 1271, 1701, 1711, 1741, 1851, 2151	BRIONVEGA	0032	ITT	0022, 0032, 0042, 0072, 0292, 0492, 0532, 0572, 0762	PIELOT	0052, 0152
TRANS CONTINENS	0451	BUSH	0002, 0282, 0332, 0342, 0512, 0972	ITT-NOKIA	0022, 0032, 0042, 0072, 0292, 0492, 0532, 0572, 0762	PIONEER	0052, 0142, 0372, 0472
TRISTAR	2281	BUSH(UK)	0812	JVC	0042, 0102, 0142, 0272, 0742, 0762, 0782, 0902	PORTLAND	0112
TRIUMPH	0481, 0581, 2121	CAPEHART	0112	KARCHER	0052, 0072, 0812	PROLINE	0432
UHER	0431, 0451, 0481, 0491, 0511, 1311, 1541	CGE	0042, 0432, 0762	KENDO	0492	PYE	0052, 0152
ULTRAVOX	0021, 0261, 0591, 1021, 1081, 1981	CRAIG	0072, 0482	KENWOOD	0042, 0142, 0572	QUARTZ	0572
UNIVERSUM	1181, 2051	CROWN	0112, 0282, 0622	LIFETEC	1142, 1162, 1172	QUELLE	0012, 0032, 0042, 0052, 0062, 0072, 0092, 0202, 0462, 0522, 0942
UNIVOX	1971	DAEWOO	0112, 0282, 0622	LLOYD	0432	RADIONETTE	0022
VEGAVOX	0811	DANSAI	0012	LOEWE OPTA	0052, 0092, 0152	REALISTIC	0012, 0072, 0132, 0432, 0482, 0502, 0532, 0572
VEXA	0101, 1511	DAYTRON	0112	LOGIK	0002, 0072, 0442	RET	1072
VICTOR	1441, 1591	DECCA	0042, 0052, 0432, 0942	LUMA	0162	REX	0042, 0742, 0782
VIDEOTON	2481	DECCA(UK)	0052	LUXOR	0492, 0572, 0812	RICOH	0952
VORTEC	0101, 0651	DEGRAAF	0052, 0132, 0432, 0532, 0602	M ELECTRONIC	0432	SABA	0042, 0142, 0192, 0222, 0242, 0392, 0632, 0732, 0742, 0762, 0772, 0782, 0792, 0872
VOXSON	0411, 0451, 0491, 1021, 1081	DIXI	0442	MAGNADYNE	0052	SAISHO	0162, 0202, 0292, 0442, 0512, 0522, 0972
WALTHAM	0451	DUAL	0042, 0632	MAGNASONIC	0572	SALORA	0192, 0572, 0812, 0822, 0912
WATSON	0431, 2201, 2241	DUMONT	0052, 0432, 0532	MANESTH	0012	SAMSUNG	0052, 0072, 0622, 0652, 1192
WATT RADIO	0021, 0061, 0261, 0591, 0641, 0761, 1091, 1971, 1981, 2001	DYNATECH	0432	MARANTZ	0012, 0052, 0092, 0122, 0502	SANSUI	0042, 0142
WEGA	0141, 1081, 1981	DYNATRON	0012	MARK	0012	SANYO	0482, 0532, 0562, 0572
WEGA COLOR	1021	ELBE	0122	MARTA	0012	SBR	0052, 0152, 0182
WELTBlick	0101	ELIN	0072	MATSUI	0012, 0442, 0512, 0522, 0812, 0972	SCHAUB LORENZ	0022, 0042
WESTON	1621	EMERSON	0012, 0162, 0202, 0432, 0512, 0522, 0912	MEDION	1142, 1162, 1172	SCHNEIDER	0002, 0012, 0052, 0072, 0432
WHITE WESTINGHOUSE	0101, 0261, 0431, 0591, 0761, 1401, 1541	ERRES	0012	MEMOREX	0012, 0132, 0432, 0482, 0532, 0572	SEG	0002, 0072
YOKO	0601, 1511	FERGUSON	0042, 0712, 0722, 0852, 0902, 1012, 1022, 1082	METZ	0062, 0092, 0932	SEI-SINUDYNE	0442
ZANUSSI	0071, 0101, 0351, 0411, 0451, 0951, 1901, 2061, 2101, 2111	FIDELITY	0432	MGA	0912	SELECO	0042
ZOPPAS	0451	FINLANDIA	0052, 0532	MICROMAXX	1142, 1162, 1172	SENTRA	0112
		FINLUX	0012, 0042, 0052, 0082, 0262, 0382, 0432, 0462, 0492, 0532, 0572, 0602, 0912	MINERVA	0062, 0092, 0252	SHARP	0132, 0502, 0702
		FIRST LINE	0002, 0912	MINOLTA	0172, 0602	SHINTOM	0002
		FISHER	0162, 0482, 0532, 0542, 0572, 0592	MITSUBISHI	0052, 0062, 0142, 0912, 0922		
		FORMENTI-PHOENIX	0012, 0052	MTC	0072, 0432		
		FRONTECH	0112	MULTITECH	0002, 0052, 0062, 0282, 0432		
		FUNAI	0432	MURPHY	0432		
		GBC	0002	N.E.I.	0012, 0052		
		GEC(UK)	0022, 0052	NATIONAL	0462		
		GELOSO	0002	NEC	0042, 0122, 0142		
		GENERAL TECHNIC	1172	NECKERMANN	0032, 0042, 0052, 0072, 0092, 0202, 0522, 0572, 0762, 0812		
		GOLDSTAR	0012, 0122, 0812, 0952	NIKKAI	0112		
		GOODMANS	0002, 0072, 0282, 0432, 0502	NOBLIKO	0092		
		GOODMANS(UK)	0002				
		GRAETZ	0022, 0042				
		GRANADA	0052, 0132, 0532, 0572				

SIEMENS 0062, 0092, 0252, 0572  
SINUDYNE 0052, 0382, 0442, 0932  
SONITRON 0532, 0572  
SONOKO 0282  
SONY 0432, 0552, 0682, 0692, 0942, 0952, 0962, 1122, 1132  
STS 0602  
SUNKAI 0512  
SUNSTAR 0432  
SYLVANIA 0432, 0912  
SYMPHONIC 0432, 0912  
TANDBERG 0062, 0162, 0522, 0932  
TASHIKO 0132, 0432  
TATUNG 0042, 0052, 0432, 0922  
TCM 1142, 1162, 1172  
TEAC 0042, 0432  
TECHNICS 0462  
TEKNIKA 0012, 0432  
TELEFUNKEN 0042, 0192, 0632, 0732, 0742, 0762, 0782, 0882, 0892  
TEMPEST 1032, 1042, 1052  
TENOSAL 0002  
THOMSON 0042, 0102, 0142, 0192, 0402, 0632, 0762  
THORN 0042, 0902  
THORN-FERGUSON 0042, 0222, 0302, 0712, 0722, 0742, 0762, 0852, 0862, 0872, 0902  
TMK 0522  
TONSAI 0002  
TOSHIBA 0042, 0622, 0912  
TOTEVISION 0012, 0072  
TRIUMPH 0922  
UHER 0042, 0072  
ULTRAVOX 0032  
UNITECH 0072  
VECTOR RESEARCH 0122  
VICTOR 0042, 0102, 0142  
VIDEON 1162, 1172  
WELTBlick 0012  
WHITE WESTINGHOUSE 0032  
XENON 0162  
YAMAHA 0042, 0122  
YOKO 0012, 0062, 0072

### Satellite Tuner

AKAI 1273  
ALBA 0823, 1273  
AMSTRAD 0163, 0793, 1013, 1023, 1293  
ANKARO 0473  
AST 0403  
ASTRA 0123  
AUSTAR 1473, 1523  
BARCOM 0473  
BLAUPUNKT 0963  
BMC SATELLITE 0103  
BRITISH TELECOM 1273  
BUSH 0823  
BUSH(UK) 0953  
CAMBRIDGE 0193, 1273  
CANAL+ 1363

CHAPARRAL 0013, 0693, 1003  
COLUMBUS 0613  
CONNEXIONS 0303, 0423  
DISCUS ELIPSE 0853, 0863  
DISKXPRESS 0423, 0473  
DRAKE 0003  
ECHOSTAR 0223, 0233, 0603, 0623, 0663, 0923, 0993, 1043, 1053, 1063, 1103  
ELTA 1283  
ELTA SAT 0143  
EURODEC 1223, 1233, 1243  
EUROSTAR 0993  
FERGUSON 0043, 0173, 0183, 0293, 0843 0953, 1303  
FINLUX 0973  
FOXTEL 1463, 1523  
FRACARRO 0023, 0533, 0773  
FUBA 0473, 0613, 0633, 1053  
GIUCAR RECORD 0203, 0333  
GRUNDIG 0173, 0943, 0953, 0963  
HIGH PERFORMANCE 0913  
HIRSCHMANN 0753, 0963, 1403, 1413, 1423, 1433, 1443  
HITACHI 0443, 0513, 0703, 0943  
ICX INTERNATIONAL 0883  
INNOVATION 2711  
ITT/NOKIA 0063, 0123, 0173, 0443, 1153  
JEEMON 0143  
JERROLD 0843, 0983  
JOHANSSON 0243  
JVC 1273  
KATHREIN 0113, 0263, 0273, 0363, 1393  
KOSMOS 0263  
KYOSTAR 1033, 1083  
LENG 0243  
LIFESAT 1323, 1343, 1353, 2711  
LUXOR 0123, 0133, 0443, 0463, 0503, 1153  
MACAB 0353  
MASPRO 0013, 0113, 0253, 0953  
MEDION 1323, 1343, 2711  
METZ 0963  
MICROMAXX 1323, 1343, 2711  
MITSUBISHI 0963  
MORGANS 0593  
MURATTO 0403  
NEC 0283, 0313, 0763, 0783, 0833  
NETWORK 0043  
NIKKO 1133, 1143  
NOKIA 0063, 0123, 0173, 0443, 1153, 1163, 1333  
NORSAT 0783  
OTTO VERSAND 0963  
PACE 0043, 0173, 0293, 0933, 0953, 1303, 1493, 1523

PACE(ONdigital) 1493  
PACE MSS 0943  
PALCOM 0613, 0683, 0703  
PALSAT 0393  
PALTEC 0703  
PANSAT 1073  
PANASONIC 0803, 1303, 1463  
PHILIPS 0323, 0343, 0473, 0953, 1123, 1183, 1193, 1203, 1213, 1303, 1313, 1533  
PHILIPS(ONdigital) 1533  
PROSAT 1173  
PTT TELECOM 0303, 0893  
QUELLE 0963  
RADIX 1053  
REDIFFUSION 0313, 0783  
RFT 1183, 1193, 1203, 1213  
SAGEM 1253  
SAKURA 0563, 0813  
SALORA 0063, 0123, 0133, 0443, 0453, 0483, 0493, 0573  
SAMSUNG 0743, 0753, 1563  
SAT 0403  
SATCOM 0893  
SATECO 0643  
SATELLITE 1543  
SECTOR 1263  
SEDEA 1093  
SENTRA 0413  
SIEMENS 0893, 0963  
SINTRACK 0903  
SKY 1453  
SKYLAB 0473  
SKYSCAN 0873  
SONY 0733, 0943  
STELLA 0303  
STRONG 0153, 0393, 1033, 1083  
STV 0633  
SUN/MOON/STAR 1473  
TANDBERG 1113  
TANDY 0913  
TANTEC 0613  
TATUNG 0513, 0543  
TECHNISAT 0083, 0093, 0523, 0553, 1053  
TELECOM 0303  
TELEMAX 0583  
TELEVES 1483, 1503, 1513, 1553  
THORN-FERGUSON 0043, 0073, 0173, 0183, 0953  
TOSHIBA 0943  
TPS 1373  
TRIAD 0403  
UNIDEN 0033, 0213, 0673, 0713, 0723  
US ELECTRONICS 0883  
VORTEC 0753, 1033, 1073  
VTECH 0433  
WINERSAT 0243  
WISI 0053, 0353, 0373, 0383, 0403, 0653, 1053, 1153  
WOLSEY 0913  
XSAT 1383  
ZEHNDER 0263, 0403  
ZENDER 0403

### Cable TV

AUSTAR 0194  
CABLETIME 0084, 0094, 0114  
CLYDE CABLEVISION 0064  
FILMNET 0034, 0074  
FOXTEL 0154, 0164, 0174  
FRANCE TELECOM 0024  
GEC 0064  
G.I. 0194  
JERROLD 0054  
MOVIE TIME 0104  
NSC 0104  
OPTUSVIS 0184  
PHILIPS 0024  
SAMSUNG 0134  
SCIENTIFIC ATLANTA 0124, 0144  
STARCOM 0054  
STS 0104  
TELE 0074  
TELE + 1 0074  
TELESERVICE 0044, 0114  
TUDI 0014  
UNITED CABLE 0054  
ZENITH 0044



YAMAHA ELECTRONICS CORPORATION, USA 6660 ORANGETHORPE AVE., BUENA PARK, CALIF. 90620, U.S.A.  
YAMAHA CANADA MUSIC LTD. 135 MILNER AVE., SCARBOROUGH, ONTARIO M1S 3R1, CANADA  
YAMAHA ELECTRONIK EUROPA G.m.b.H. SIEMENSSTR. 22-34, 25462 RELINGEN BEI HAMBURG, F.R. OF GERMANY  
YAMAHA ELECTRONIQUE FRANCE S.A. RUE AMBROISE CROIZAT BP70 CROISSY-BEAUBOURG 77312 MARNE-LA-VALLÉE CEDEX02, FRANCE  
YAMAHA ELECTRONICS (UK) LTD. YAMAHA HOUSE, 200 RICKMANSWORTH ROAD WATFORD, HERTS WD1 7JS, ENGLAND  
YAMAHA SCANDINAVIA A.B. J Å WETTERGRENS GATA 1, BOX 30053, 400 43 VÄSTRA FRÖLUNDA, SWEDEN  
YAMAHA MUSIC AUSTRALIA PTY, LTD. 17-33 MARKET ST., SOUTH MELBOURNE, 3205 VIC., AUSTRALIA

YAMAHA CORPORATION  
Printed in China ID V586140

# AV-S70 Connection Guide

## Connecting to a TV (monitor) without audio output terminals

When enjoying digital audio

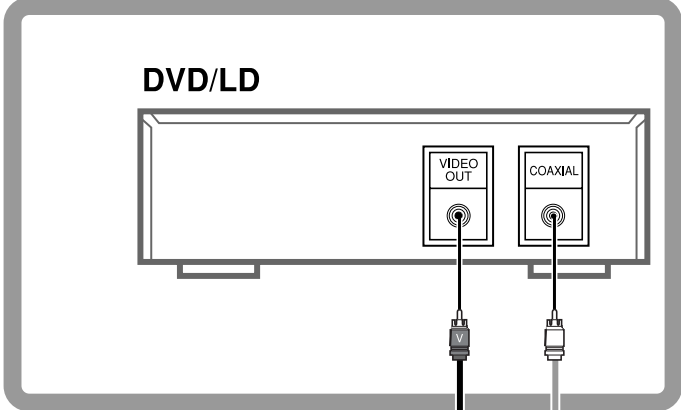

Front speaker unit AV-S70

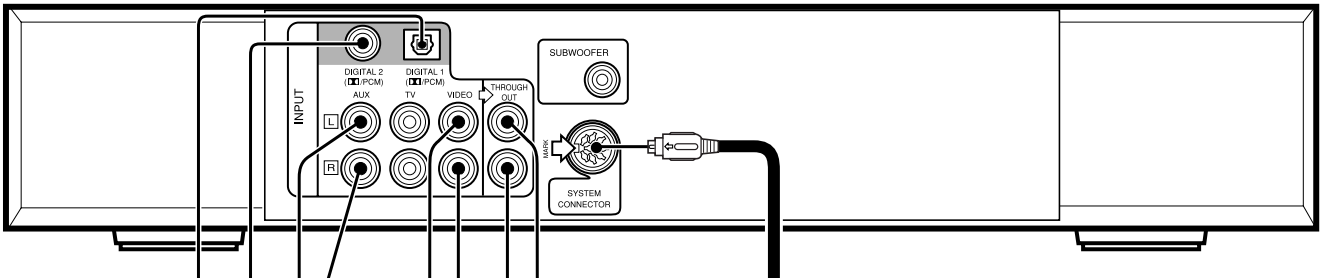

YAMAHA subwoofer and rear speakers  
(sold separately) NX-SW70

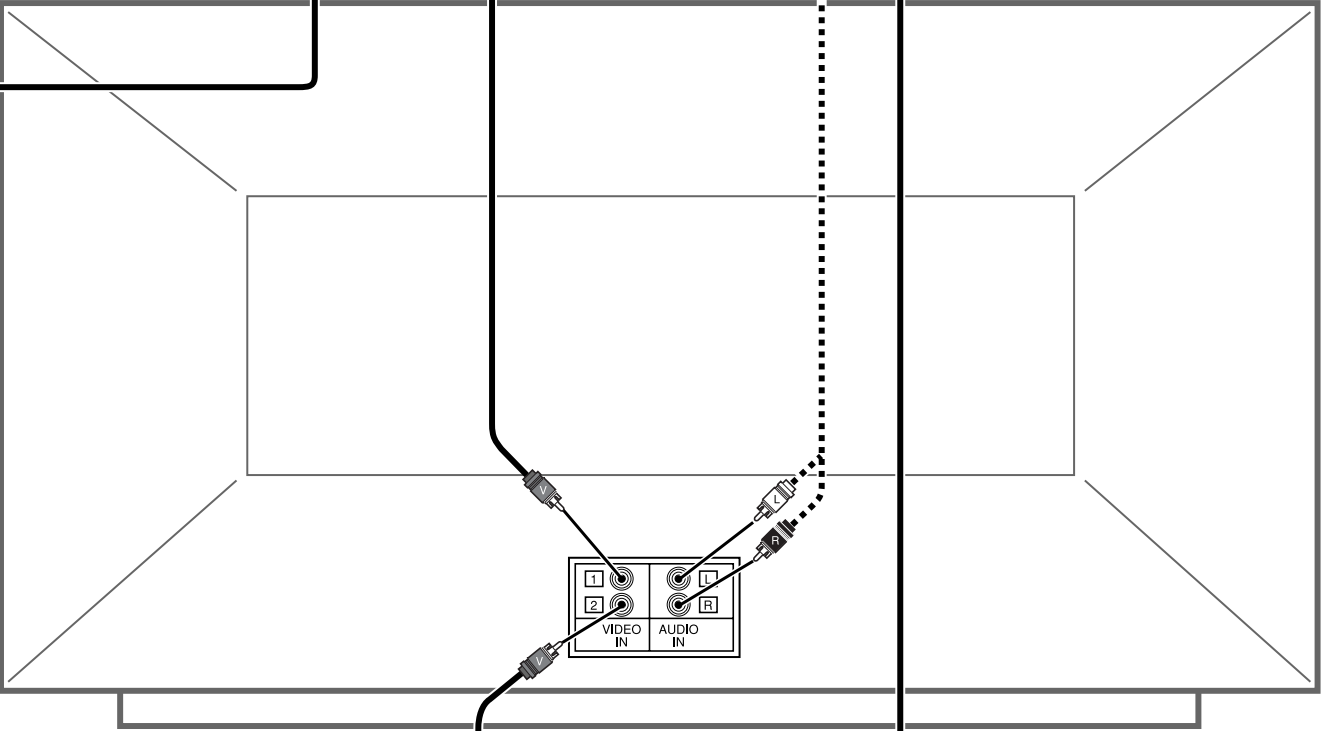
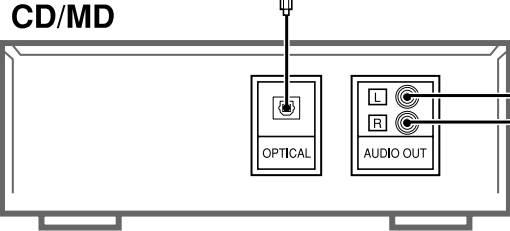
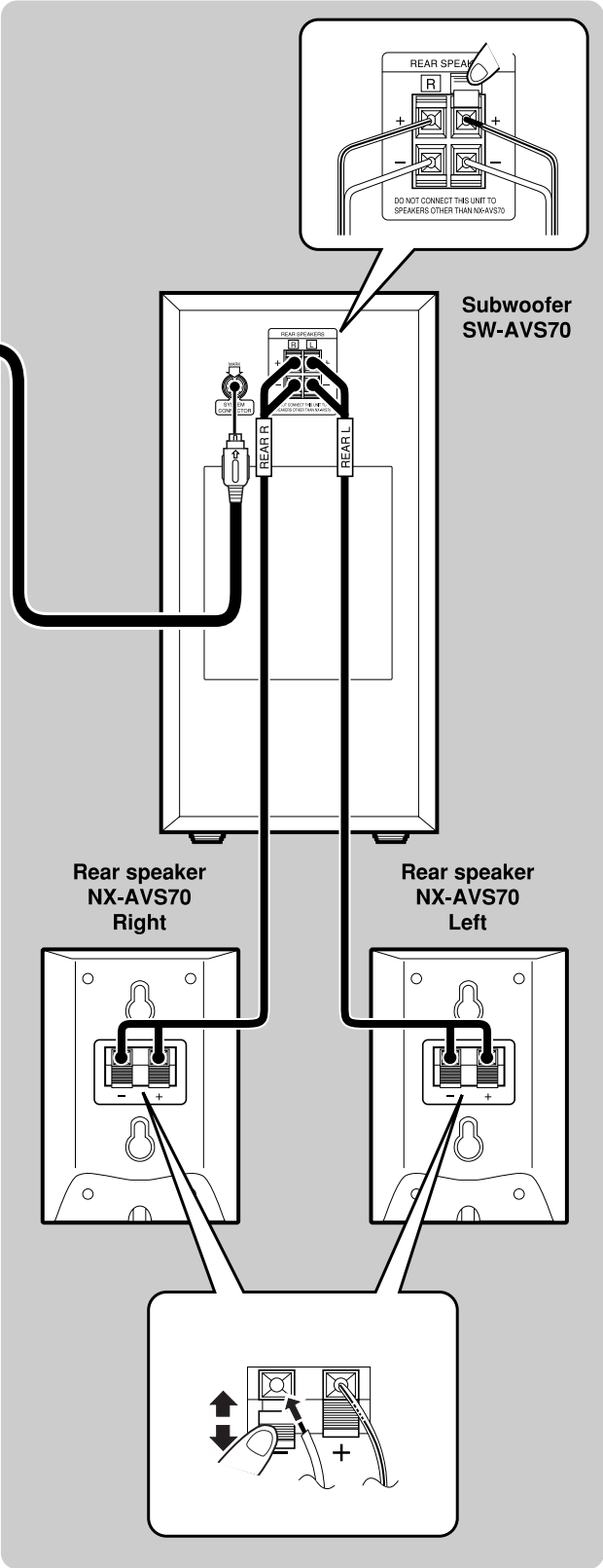

TV (monitor)

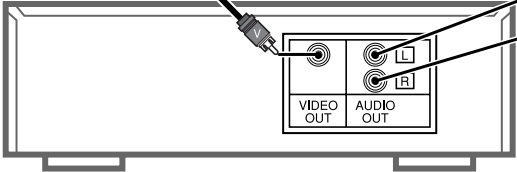
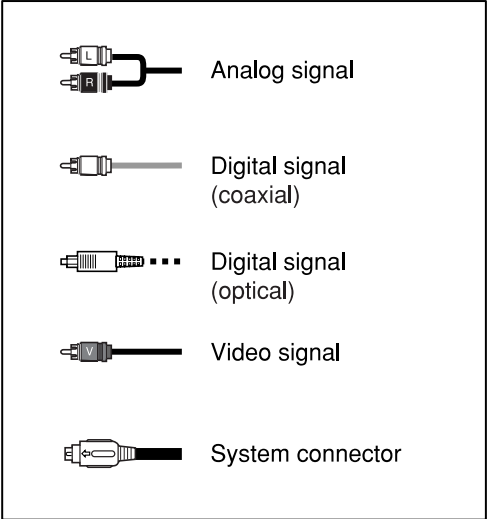

VCR

# AV-S70

## Connection Guide

# Connecting to a TV (monitor) with audio output terminals

When enjoying digital audio

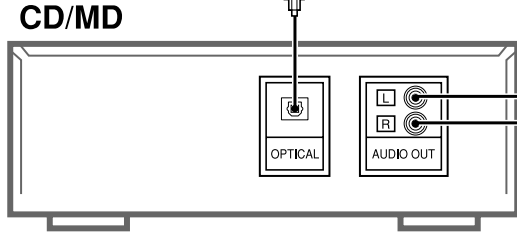
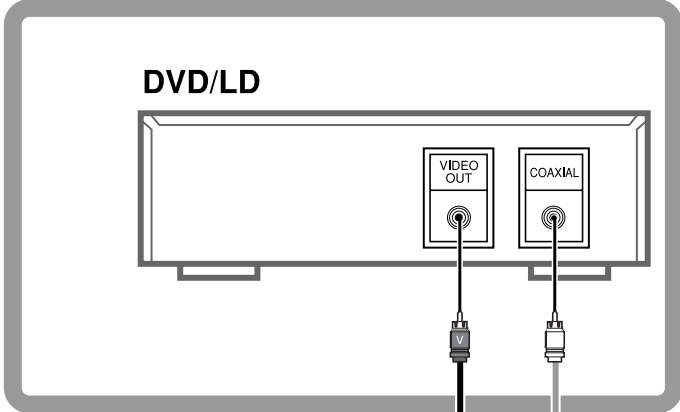

Front speaker unit AV-S70

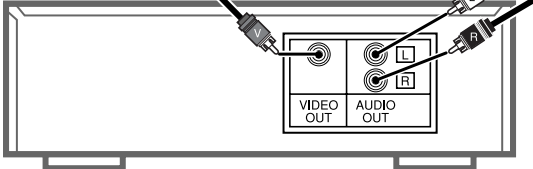
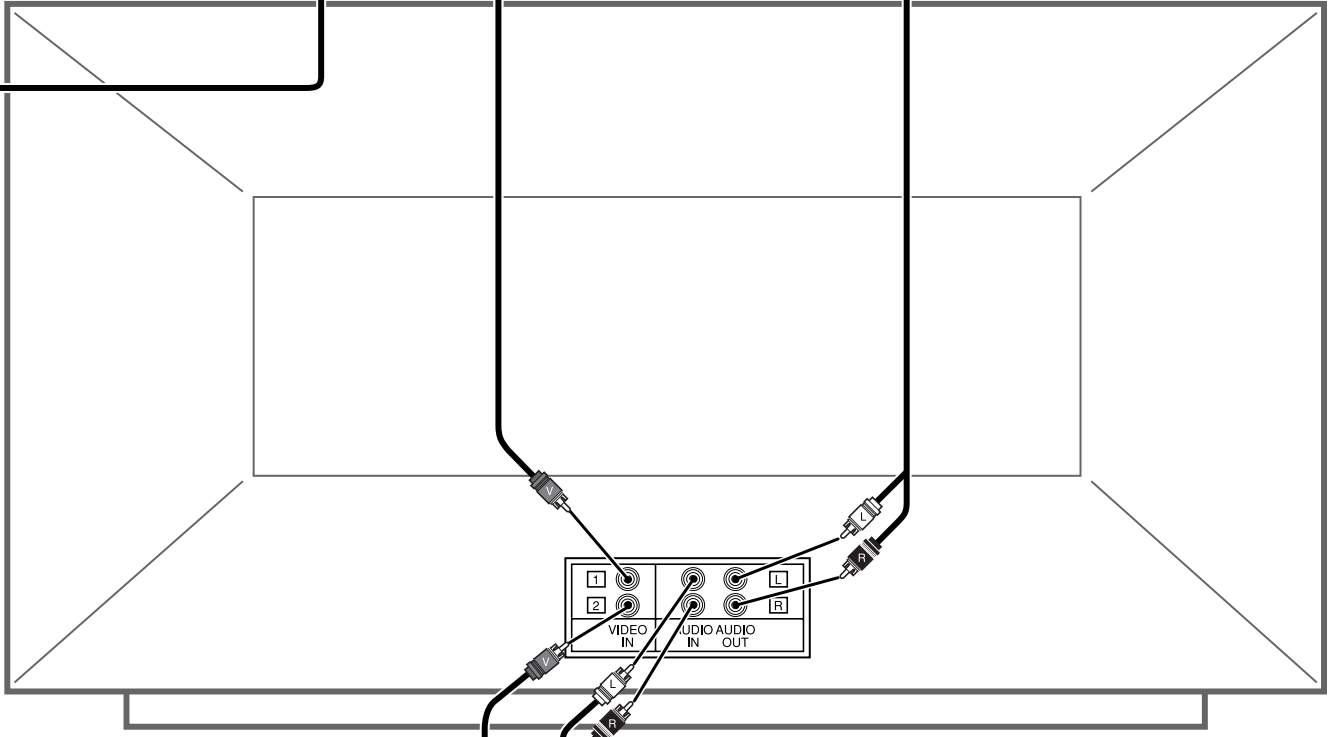
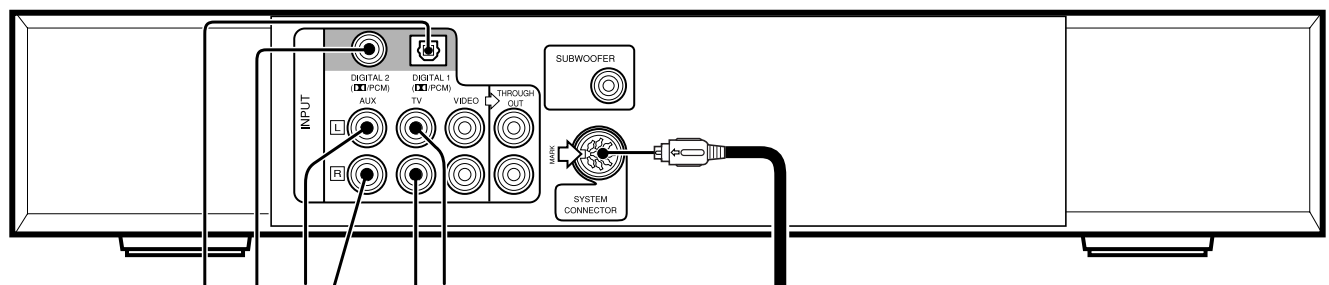

- Analog signal
- Digital signal (coaxial)
- Digital signal (optical)
- Video signal
- System connector

YAMAHA subwoofer and rear speakers (sold separately NX-SW70)

