

YAMAHA

Professional Series Power Amplifier

PD2500

Operating Manual

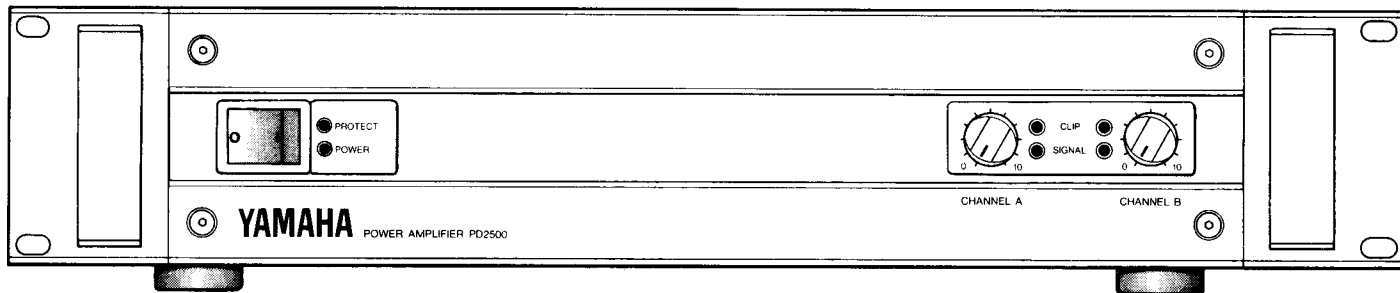

INTRODUCING THE PD2500

The PD2500 is a high-performance stereo power amplifier designed specifically for sound reinforcement and other professional applications. It offers high power — 500 RMS watts per channel into 2-ohm loads, or 1 000 watts in bridged mono operation into a 4-ohm load — while at the same time being remarkably light, compact and easy to handle. The PD2500 weighs only 12 kilograms (about 26-1/2 pounds), and fits neatly in a 2U 19" rack space. Naturally, basic performance, sound quality and reliability have not been compromised for the sake of reduced weight. The PD2500 is designed and constructed to the same high standards that make other Yamaha Professional Series Power Amplifiers leaders in the field.

We urge you to read this operation manual thoroughly before using the PD2500 in order to take full advantage of its superior performance capabilities.

CONTENTS

| | |
|--------------------------------------|----|
| PD2500 FEATURES | 2 |
| PRECAUTIONS | 2 |
| OPERATION | 3 |
| MOUNTING | 5 |
| GENERAL SPECIFICATIONS | 6 |
| PERFORMANCE GRAPHS | 7 |
| WHAT THE SPECIFICATIONS MEAN | 9 |
| COOLING FAN FILTER MAINTENANCE | 10 |
| BLOCK DIAGRAM | 10 |
| DIMENSIONS | 11 |

PD2500 FEATURES

● New Power Supply Design For Compact Size/ Light Weight

Recent advances in high-power high-speed switching semiconductor fabrication and high-frequency transformer technology have been applied in the PD2500 to provide a high-frequency switching power supply that is remarkably light and compact. The switching frequency has been increased to a point at which it can have no adverse effects on the audio signal, ensuring optimum sound quality. The power supply is exceptionally stable, and has plenty of capacity to deliver dynamic peaks without losing output and causing distortion. The PD2500 switching power supply also achieves far better regulation than conventional transformer-based designs, providing an audible improvement in low-frequency reproduction and power.

● Low-impedance Drive Capability

The PD2500 has been designed with plenty of current drive capability, and can deliver full power channel into 2-ohm loads (stereo operation) without a trace of strain*.

● Monaural Operation

In bridged mono operation the PD2500 will deliver extra high power into a 4-ohm load.* Bridged hookup is simple: just set the rear panel STEREO/MONO switch to MONO, and apply the input signal to the A channel input connector. Speaker output is taken directly from the two outermost speaker terminals (see "MONO OPERATION" in the "OPERATION" section).

● LED Status Indicators

The PD2500 has a number of LED indicators which monitor the amplifier's operating status:

1. Power indicator.
2. PROTECTION indicator lights when the internal muting or protection circuitry is active.
3. SIGNAL LEDs provided for each channel light when a 2-volt or higher audio signal appears at the corresponding outputs.
4. CLIP LEDs light to warn of total harmonic distortion levels equal to or greater than 1%.

● Protection Circuitry

A full complement of protection circuitry is provided in the PD2500 to prevent damage to the amplifier and related equipment:

1. A muting circuit mutes amplifier output for approximately 6 seconds after the power is turned ON, allowing time for the circuitry to stabilize prior to operation.
2. DC sensing circuitry shuts off amplifier output if a DC voltage greater than plus or minus 2 volts is detected at the outputs.
3. Thermal protection shuts off output if the heat sink temperature exceeds 85 degrees C.
4. Current limiter circuitry reduces output power if the load impedance falls below 1 ohm.

● 2-speed Cross-flow Cooling Fan

A reliable cross-flow fan pulls in fresh air through a recess in the front panel and a portion of the top panel, and expels it via the amplifier's back. A 2-speed fan control circuit with hysteresis switching to high speed when the heat sink temperature exceed 60 degrees C, and resumes low-speed operation when the temperature drops to 45 degrees C.

● Recessed Input Attenuators

31-position detented input attenuators are calibrated in 1-dB steps so specific settings can be noted and easily reset when required. The attenuators are located well back in the panel recess to avoid accidental alterations of critical settings.

● Balanced Inputs

The PD2500 features high-performance electronically balanced input circuitry with rugged XLR type input connectors. This provides full compatibility with professional sound equipment, and ensures secure, electrically solid connections.

* Minimum load impedance for Canadian model is 4 ohms in stereo mode, 8 ohms in mono mode.

PRECAUTIONS

1. AVOID EXCESSIVE HEAT, HUMIDITY, DUST AND VIBRATION

Keep the unit away from locations where it is likely to be exposed to unusually high temperatures or humidity. Also avoid locations which are subject to excessive dust accumulation or vibration which could cause mechanical damage.

2. AVOID PHYSICAL SHOCKS

Strong physical shocks to the unit can cause damage. Handle it with care.

3. DO NOT OPEN THE CASE OR ATTEMPT REPAIRS OR MODIFICATIONS YOURSELF

This product contains no user-serviceable parts. Refer all maintenance to qualified Yamaha service personnel. Opening the case and/or tampering with the internal circuitry will void the warranty.

4. MAKE SURE POWER IS OFF BEFORE MAKING OR REMOVING CONNECTIONS

Always turn the power OFF prior to connecting or disconnecting cables. This is important to prevent damage to the unit itself as well as other connected equipment.

5. HANDLE CABLES CAREFULLY

Always plug and unplug cables — including the AC cord — by gripping the connector, not the cord.

6. CLEAN WITH A SOFT DRY CLOTH

Never use solvents such as benzine or thinner to clean the unit. Wipe clean with a soft, dry cloth.

7. ALWAYS USE THE CORRECT POWER SUPPLY

Make sure that the power supply voltage specified on the rear panel matches your local AC mains supply. Also make sure that the AC mains supply can deliver more than enough current to handle all equipment used in your system.

OPERATION

FRONT PANEL

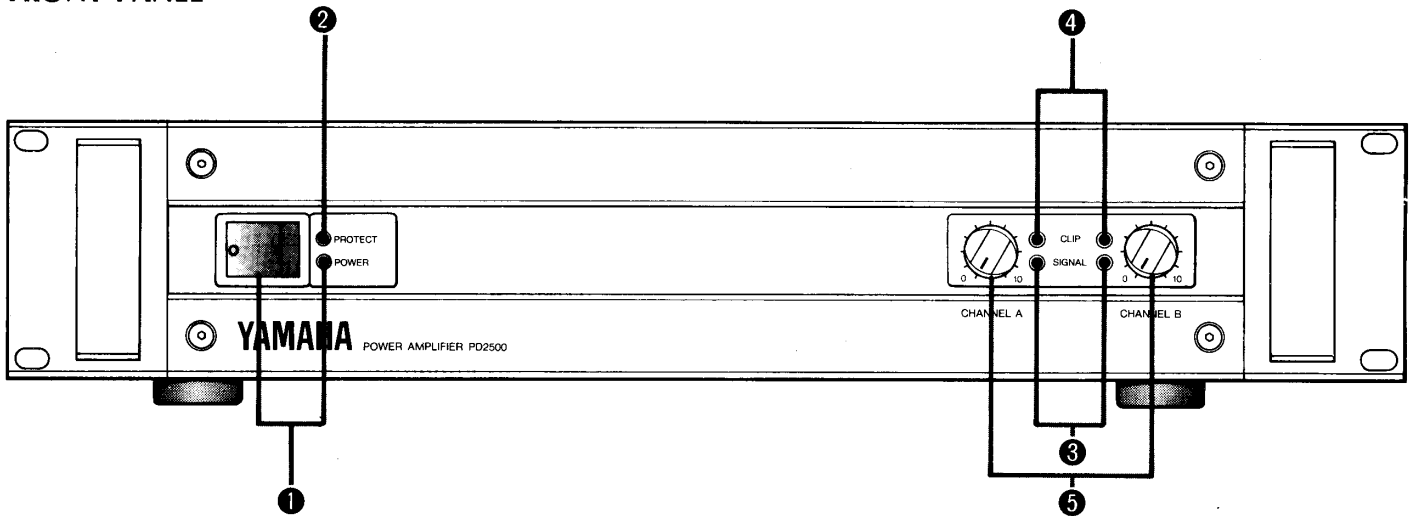

❶ POWER Switch & Indicator

The see-saw-type switch turns power ON and OFF. Pressing the power switch to the side with the "I" symbol turns power ON, and pressing to the "O" side turns power OFF.

CAUTION!

The power amplifier should be the LAST piece of equipment turned on in any system. This is to avoid damage to the power amplifier and speakers due to power-surge "thumps" generated by turning on other equipment. The only exception to this rule is when the entire system is switched on simultaneously through a master power switch.

❷ PROTECT Indicator

The PROTECT indicator will light during the muting period (approximately 6 seconds) immediately after the power is switched ON. The speaker outputs are shut off during the muting period. The PROTECTION indicator will also light if the protection circuitry is activated during amplifier operation due to detection of a DC voltage at the outputs or excessively high heat sink temperatures. The protection circuitry is self-resetting, and normal operation will resume as soon as the condition which caused protection circuit activation is eliminated.

THERMAL PROTECTION

The protection circuitry is activated when the heat sink temperature equals or exceeds 85°C. The protection circuit will be reset and normal amplifier operation will resume as soon as the heat sink temperature falls below 85°C.

DC PROTECTION

The protection circuitry will be activated when a DC voltage greater than ± 2 V or an extremely low-frequency signal around 1 Hz, 20 V peak-to-peak is detected at the amplifier's outputs. To avoid this, make sure that the input signal fed to the amplifier has no DC offset and that it contains no extremely low frequencies in the vicinity of 1 Hz.

❸ SIGNAL Indicators

The SIGNAL indicators, one for each channel, light when the corresponding channel produces an audio signal output of greater than 2 volts anywhere between 20 Hz and 20,000 Hz.

❹ CLIP Indicators

Independent CLIP indicators are provided for channel A and channel B. They light when the output distortion of the corresponding channel reaches or exceeds 1% (THD). Should either of the CLIP indicators light during amplifier operation — indicating clipping due to excessive signal levels — the input signal level should be decreased either at the source or by using the PD2500 input attenuators.

❺ Input Attenuators

Independent input attenuators for channels A and B are calibrated and detented in 31 1-dB steps. Rotated fully clockwise attenuation is 0 dB, and the maximum counter-clockwise setting provides infinite attenuation (i.e. channel OFF).

REAR PANEL

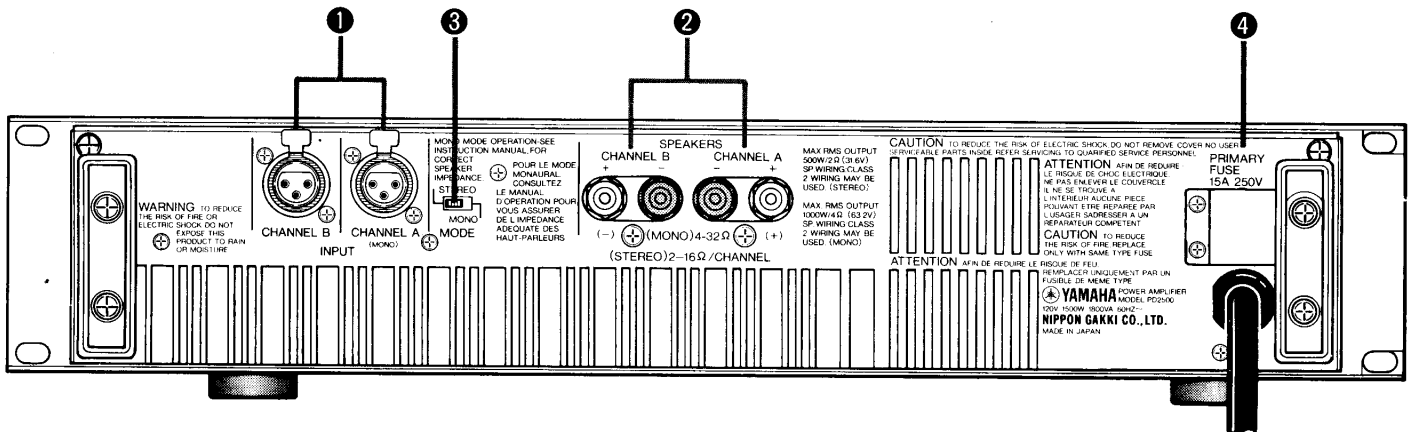

U.S. & Canadian models

1 INPUT Connectors

Both the A and B channel inputs are electronically balanced with an input impedance of greater than or equal to 15 k-ohms and a rated input level of +4 dBm. The input connectors are XLR-3-31 types, and are wired as follows:

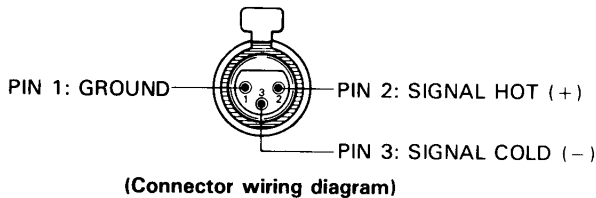

UNBALANCED SIGNAL INPUT

Unbalanced signals may be fed directly to the PD2500 inputs by connecting the unbalanced ground line to both the ground and signal cold input pins (pins 1 and 3) and connecting the unbalanced signal line to the signal hot input pin (pin 2). Another method would be to use a balancing transformer (1:1 ratio) prior to the PD2500 inputs. When selecting a balancing transformer, be certain that it is designed to handle signal levels of upto +24 dBu. Transformers designed for microphone level use are not appropriate for line level applications and will adversely effect system performance.

2 SPEAKER Output Terminals

For normal stereo operation, the red or “+” speaker output terminals should be connected to the red or “+” terminals on the speakers and the black or “-” output terminals to the corresponding black or “-” terminals on the speakers. For speaker connection in the PD2500 monaural mode, refer to “MONO OPERATION,” below.

3 STEREO/MONO MODE Switch

This switch sets the PD2500 for operation in the STEREO or MONO mode. Always make sure that the MODE switch is set to the correct position for the mode in which the PD2500 is to be operated.

MONO OPERATION

- To set up for monaural operation, first make sure that the amplifier is OFF!
- Set the MODE switch to the MONO position.
- Connect the input source to the CHANNEL A input. CHANNEL B is inactive in the MONO mode.
- Connect the red or “+” speaker lead to the CHANNEL A “+” (red) speaker output terminal. Connect the black or “-” speaker lead to the CHANNEL B “+” (red) speaker output terminal.

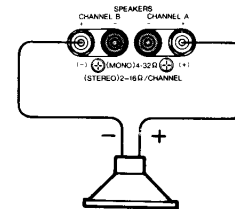

The correct “+” and “-” speaker connections for the MONO mode are actually marked below the speaker terminals.

- Use only the CHANNEL A input attenuator for sensitivity adjustment.

4 FUSE

This fuse helps to protect the power supply against power-line surges and long-term overloads at the outputs. The amplifier is designed to avoid unwanted shutoff during a live performance, but it's better to blow a fuse and replace it than to loose the amp altogether.

WARNING

ONLY USE FUSES OF THE SAME RATING AND TYPE AS THE ORIGINAL FUSE SPECIFIED FOR THE POWER AMPLIFIER. This information is printed on the amplifier rear panel, and is repeated here for convenience:

U.S. & Canadian models..... 15A 250V
General model..... 5A 250V x 2

MOUNTING

Shelf Mounting

The PD2500 can be used on any flat, level surface as long as there is adequate ventilation. Do not remove the amplifier's feet as this would block airflow through the bottom panel.

Permanent-installation Rack Mounting

The PD2500 can be mounted in any standard 19" electronic equipment rack. The rear panel of the rack should be left open to promote smooth airflow. Cooling fans are required for rack-mounted PD2500's if they must produce extremely high average power output (i.e. stereo operation into 2-ohm, 4-ohm loads or mono operation into a 4-ohm, 8-ohm load). Refer to the diagrams to the right for the ideal cooling fan configuration.

Portable Rack Mounting

Road cases must be durable enough to withstand rough handling and airline travel. Secure the back end of the PD2500 side panels to the rack with the screws provided, and provide cooling fans (like those shown to the right) if ventilation is restricted.

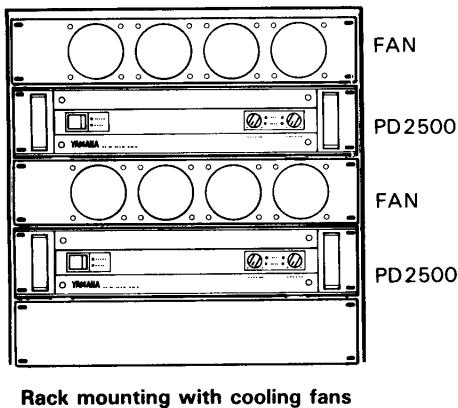
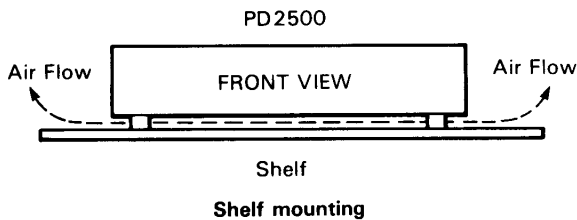

Fan Panel

The panel shown uses four fans, each with a maximum volume of 30 CFM (Cubic feet per minute) and a maximum pressure of 7mm H₂O.

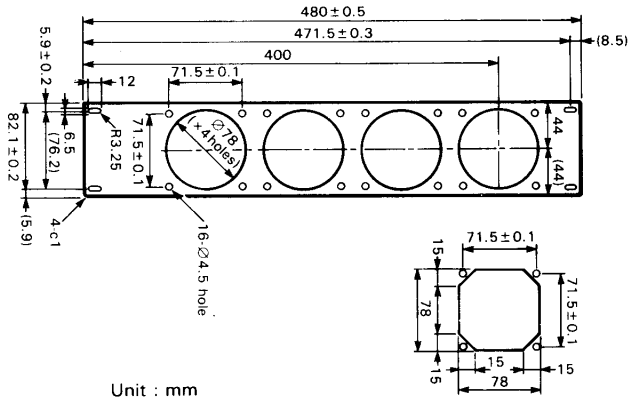

Fan panel

CAUTION!

If unit(s) are to be used in a rack mounted installation, it is recommended that fan cooling be installed. Without fan cooling, units could be damaged from excessive temperature conditions.

The minimum required airflow rate for fans should be 4 × 30 cubic feet per minute (CFM). Use only fans with the above specification.

The following are some examples of fans with the proper specifications:

| Manufacturer | Type/Model | Airflow Rate |
|--------------|----------------------|--------------|
| ETRI INC. | 126 LF or equivalent | 30 CFM |

Side Panel Support Screws

Use the upper screw hole on each side panel. Use only the supplied screws (millimeter thread).

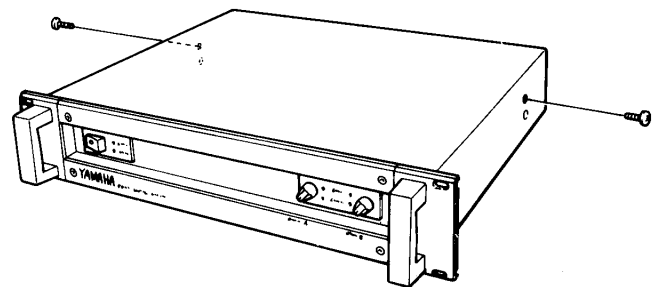

GENERAL SPECIFICATIONS

POWER OUTPUT LEVEL

STEREO: 250W + 250W, RL = 8 ohms, f = 1 kHz, THD = 0.1%
360W + 360W, RL = 4 ohms, f = 1 kHz, THD = 0.1%
500W + 500W, RL = 2 ohms, f = 1 kHz, THD = 0.2%
BTL-MONO: 500W, RL = 16 ohms, f = 1 kHz, THD = 0.1%
700W, RL = 8 ohms, f = 1 kHz, THD = 0.1%
1000W, RL = 4 ohms, f = 1 kHz, THD = 0.2%

FREQUENCY RESPONSE

± 1.0 dB, F = 10 Hz – 50 kHz, RL = 8 ohms, Po = 1W

POWER BANDWIDTH (≤ 0.1% THD)

STEREO: 20 Hz – 50 kHz, Po = 125W, RL = 8 ohms
20 Hz – 50 kHz, Po = 180W, RL = 4 ohms
BTL-MONO: 20 Hz – 50 kHz, Po = 250W, RL = 16 ohms
20 Hz – 50 kHz, Po = 360W, RL = 8 ohms

TOTAL HARMONIC DISTORTION

STEREO: ≤ 0.007%, Po = 125W, f = 20 Hz – 20 kHz,
RL = 8 ohms
≤ 0.015%, Po = 180W, f = 20 Hz – 20 kHz,
RL = 4 ohms
≤ 0.03%, Po = 250W, f = 20 Hz – 20 kHz,
RL = 2 ohms
BTL-MONO: ≤ 0.007%, Po = 250W, f = 20 Hz – 20 kHz,
RL = 16 ohms
≤ 0.015%, Po = 350W, f = 20 Hz – 20 kHz,
RL = 8 ohms
≤ 0.03%, Po = 500W, f = 1 kHz, RL = 4 ohms

INTERMODULATION DISTORTION (60 Hz : 7 kHz = 4 : 1)

STEREO: ≤ 0.007%, Po = 125W, RL = 8 ohms
≤ 0.01%, Po = 175W, RL = 4 ohms
≤ 0.02%, Po = 250W, RL = 2 ohms
BTL-MONO: ≤ 0.007%, Po = 250W, RL = 16 ohms
≤ 0.01%, Po = 350W, RL = 8 ohms
≤ 0.02%, Po = 500W, RL = 4 ohms

CHANNEL SEPARATION

(RL = 8 ohms, Po = 1/2 Po(max.), ATT max., Input 600-ohm shunt)
≥ 90 dB, f = 1 kHz
≥ 70 dB, f = 20 Hz – 20 kHz

DAMPING FACTOR

≥ 250, f = 1 kHz, RL = 8 ohms

SIGNAL-TO-NOISE RATIO

≥ 106 dB, INPUT 600-ohm shunt, @ fc = 12.7 kHz 6-dB/oct LFP
≥ 115 dB, INPUT 600-ohm shunt, @ IHF-A Network

SLEW RATE

STEREO: ± 55 V/μS, RL = 8 ohms, full swing
BTL-MONO: ± 110 V/μS, RL = 16 ohms, full swing

SENSITIVITY

+4 dBm (1.23 V rms), Po = 500W, RL = 2 ohms, ATT max.,
f = 1 kHz

VOLTAGE GAIN

28.2 dB, ATT max., f = 1 kHz

INPUT IMPEDANCE

≥ 15 k-ohms, ATT max., balanced or unbalanced

RESIDUAL NOISE

≤ -76 dBm, ATT min., @ fc = 12.7 kHz 6-dB/oct LFP
≤ -90 dBm, ATT min., @ IHF-A Network

INDICATORS

Signal: Green LED, f = 20 Hz – 20 kHz, Vo ≥ 2 V
Clip: Red LED, THD ≥ 1%
Protection: Red LED, lights during protection or muting circuit
operation
Pilot: Red LED, power ON

PROTECTION CIRCUITS

Muting: 6 ± 2 sec. after power turned ON
DC Sense: DC ± 2 V output voltage
Ultra-Low Frequency: 20 V p-p, f = 1 Hz (Po = 6.2W, RL = 8 ohms)
Thermal: ≥ 85°C heat sink temperature
PC Limiter: RL ≤ 1.0 ohms

COOLING FAN SPEED CONTROL CIRCUIT

High-speed @ ≥ 60°C heat sink temp.
Low-speed @ < 45°C heat sink temp.
Fan life: more than 10,000 hrs. at high-speed.

CONTROLS

Front: Rocker-type POWER switch
31-detent A-curve attenuators × 2
(only CH A functions during BTL-MONO operation)
Rear: STEREO/MONO mode switch

POWER REQUIREMENTS

General model: 240 VAC, 50/60 Hz
U.S. & Canadian models: 120 VAC, 50/60 Hz

POWER CONSUMPTION

General model: 2500W
U.S. & Canadian models: 1500W, 1800 VA

DIMENSIONS (W × H × D)

480mm × 97mm × 480mm (18-7/8" × 3-7/8" × 18-7/8")

WEIGHT

Approximately 12 kilograms (26.5 lbs)

• All specifications subject to change without notice.

PERFORMANCE GRAPHS

FREQUENCY RESPONSE CHARACTERISTICS

Load Impedance: 8Ω
 Input Attenuators: Max
 Mode: STEREO
 $0dB = 1W/8\Omega$

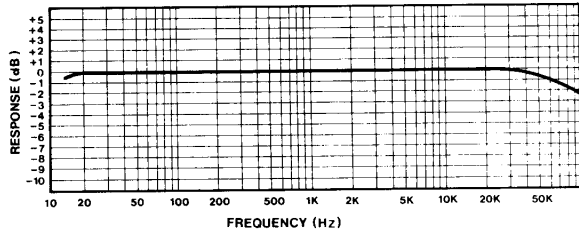

THD vs OUTPUT POWER CHARACTERISTICS

Load Impedance: 16Ω
 Mode: MONO (BTL)

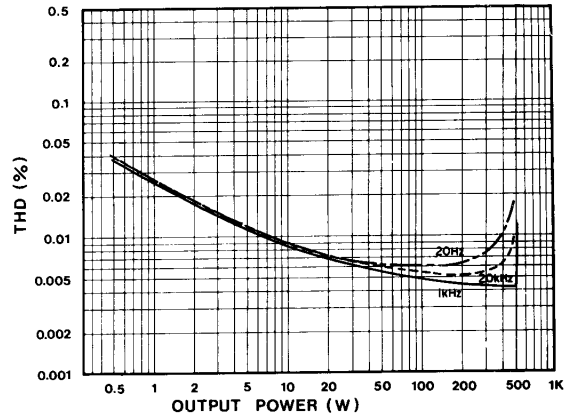

THD vs OUTPUT POWER CHARACTERISTICS

Load Impedance: 8Ω
 Mode: STEREO
 Both Channels Driven

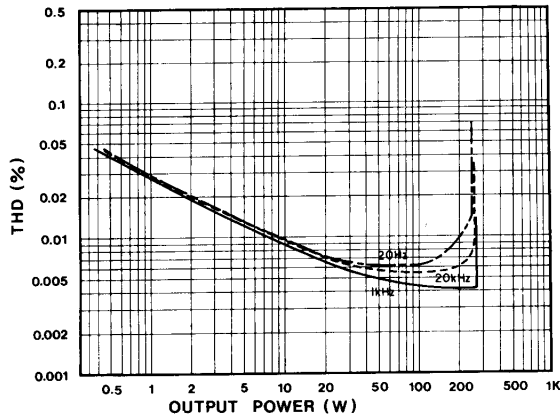

THD vs OUTPUT POWER CHARACTERISTICS

Load Impedance: 8Ω
 Mode: MONO (BTL)

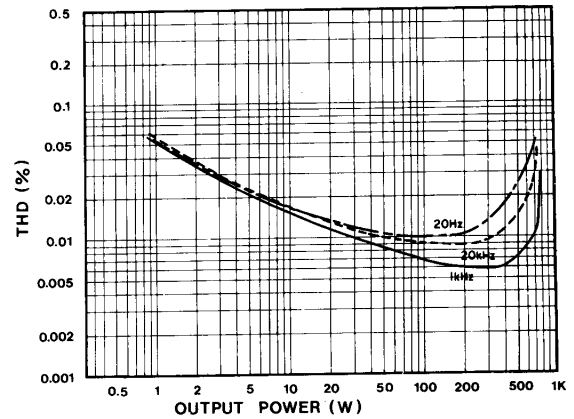

THD vs OUTPUT POWER CHARACTERISTICS

Load Impedance: 4Ω
 Mode: STEREO
 Both Channels Driven

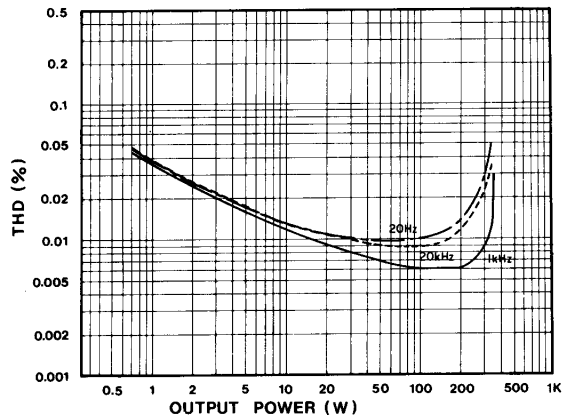

THD vs FREQUENCY CHARACTERISTICS

Load Impedance: 8Ω
 Mode: STEREO
 Both Channels Driven
 Output Power: 125W constant

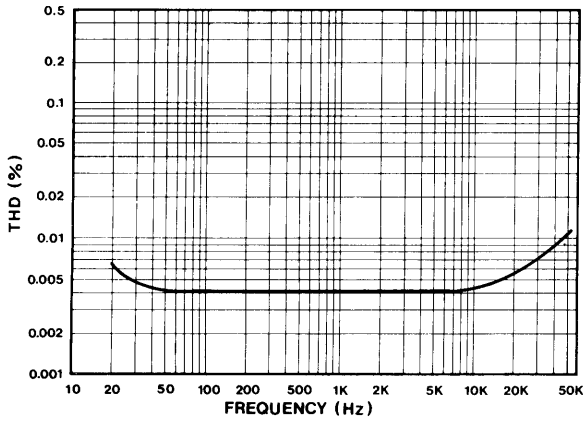

CHANNEL SEPARATION CHARACTERISTICS

Load Impedance: 8Ω
 0dB = 100W constant
 Measuring Channel
 Input 600Ω Shunt

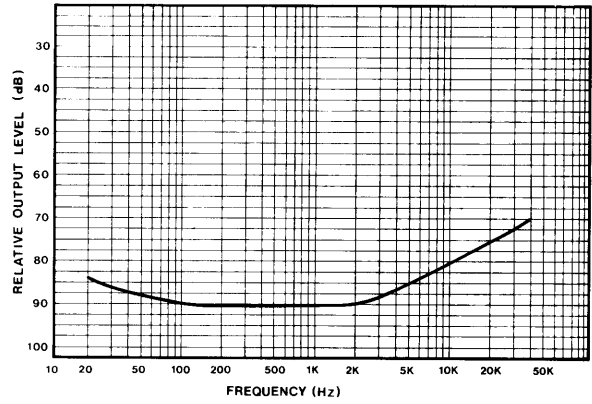

THD vs FREQUENCY CHARACTERISTICS

Load Impedance: 4Ω
 Mode: STEREO
 Both Channels Driven
 Output Power: 175W constant

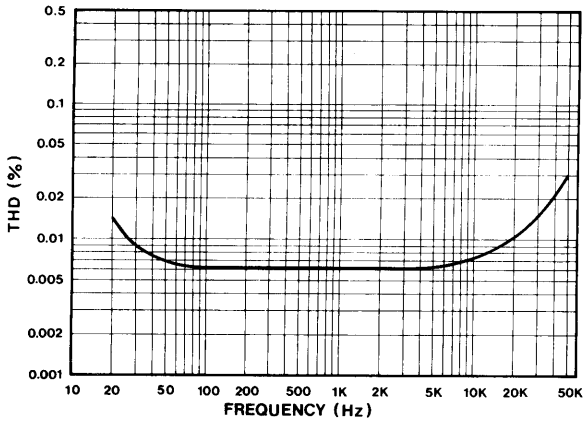

DAMPING FACTOR CHARACTERISTICS

Load Impedance: 8Ω
 ON/OFF method

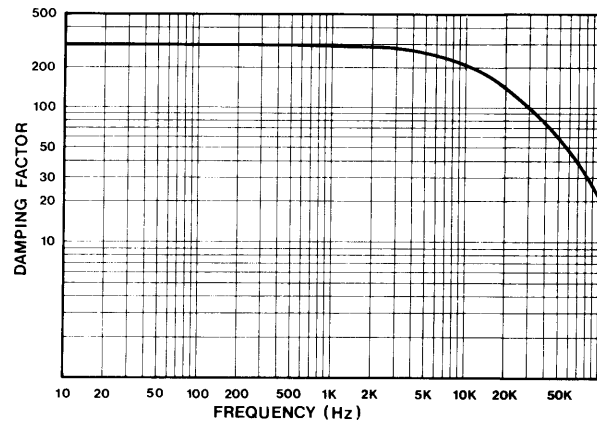

Distortion measurements made using HP339A.

WHAT THE SPECIFICATIONS MEAN

POWER OUTPUT

The power output specifications of the PD2500 are given for "RMS" or "average" power output. This value is measured with a continuous sine wave input signal, and is equal to the amplifier's RMS output voltage squared, then divided by the load impedance. When making power measurements it is essential that the AC power supply has less than 3% distortion and sufficient current capacity.

Also, the test signal must not be allowed to clip as this could cause the fuse to blow.

FREQUENCY RESPONSE

Frequency response is the variation in the amplifier's output level with a fixed-level input signal swept across a given range of frequencies. The PD2500, for example, shows no more than a ± 1 dB variation in output level across a 20 Hz to 50 kHz frequency range. A flat (minimum variation) frequency response across at least the full audible frequency range is essential for accurate sound reproduction.

POWER BANDWIDTH

The power bandwidth specification describes the amplifier's ability to deliver high power across a wide frequency range. The upper and lower limits of the power bandwidth are defined as the frequencies at which the amplifier can only deliver 1/2 of the power it delivers at 1 kHz. This specification is measured with the amplifier delivering full power (before clipping) at 1 kHz.

TOTAL HARMONIC DISTORTION

Total harmonic distortion (sometimes noted as THD) is the sum of all harmonics appearing at the amplifier's output that were not present in the original input signal. THD is expressed as a percentage of the total signal. Unwanted harmonics are added to the original signal by non-linearity in amplifier operation — i.e. the amplifier's output waveform is not a precise representation of the input waveform. An extreme example of non-linear operation is clipping, in which the peaks of the signal waveform are actually "clipped" or squared off.

INTERMODULATION DISTORTION

Intermodulation distortion (IM) is the appearance of frequencies in the output waveform which are equal to the sums and differences of integral multiples of two or more input frequencies. Intermodulation distortion is measured by applying two different frequencies to the amplifier's input (usually 60 Hz and 7 kHz) and measuring the amount of all other frequencies that appear at the output. IM distortion — the amount of unwanted frequencies generated — is expressed as a percentage of the total signal.

CHANNEL SEPARATION

Channel separation is tested by applying a signal to one channel of a stereo amplifier and measuring the amount of signal output from the other channel. High channel separation is essential to maintain optimum stereo separation and imaging with stereo programs.

DAMPING FACTOR

Damping factor is equal to a specified load impedance (speaker impedance) divided by the amplifier's output impedance into the specified load. A high damping factor indicates that the amplifier has a good ability to "damp" unwanted speaker cone motion (overshoot), thus delivering a cleaner, tighter sound in the bass region.

SLEW RATE

Slew rate describes how well an amplifier can follow rapid signal changes. Obviously high-frequency signals have a faster rise time and therefore a faster slew rate than low-frequencies, but the maximum slew rate required by an amplifier is NOT defined by the highest frequency it handles. Composite signals (i.e. many frequencies combined) often produce extremely fast-rising waveforms which must be followed precisely to provide accurate reproduction. Further, the slew rate of a signal increases as its amplitude increases. A high slew rate is important in achieving good transient response and clean, "transparent" reproduction.

COOLING FAN FILTER MAINTENANCE

The filter element is removed and cleaned as follows.

1. Remove the two upper screws on the front panel with a 3mm Allen (hex) wrench. Remove the filter cover.
2. Remove filter element and wash with plain water. Detergent may also be used if the filter is exceptionally dirty.
3. Dry the filter thoroughly. NEVER REPLACE THE FILTER WHILE IT IS WET!
4. Replace the filter and filter cover.

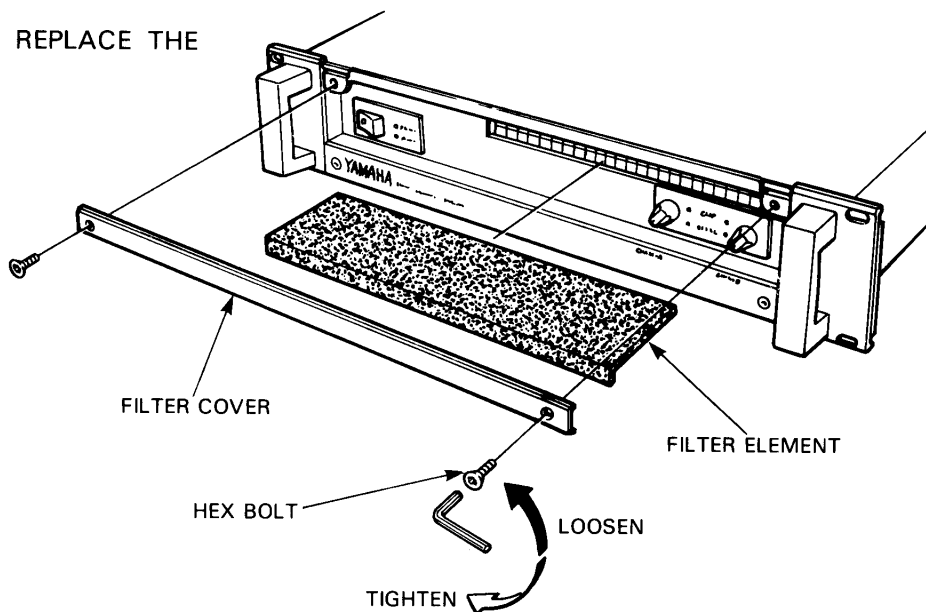

BLOCK DIAGRAM

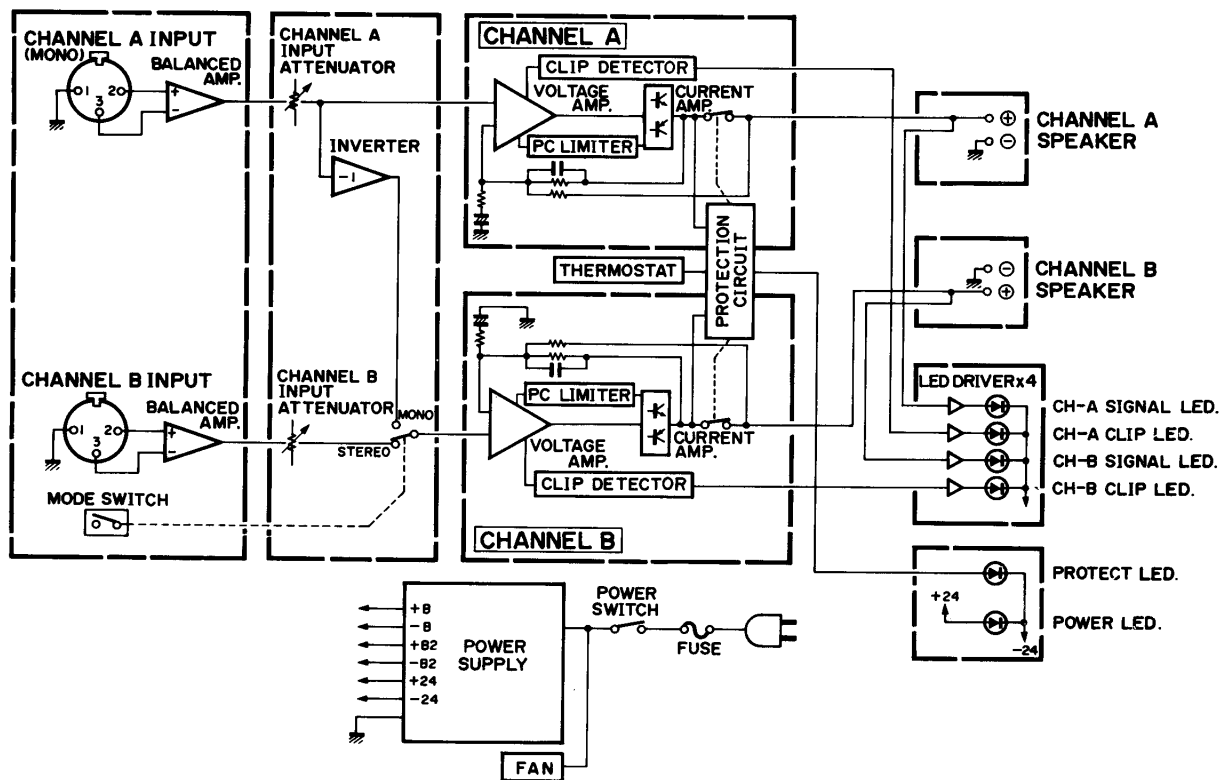

DIMENSIONS

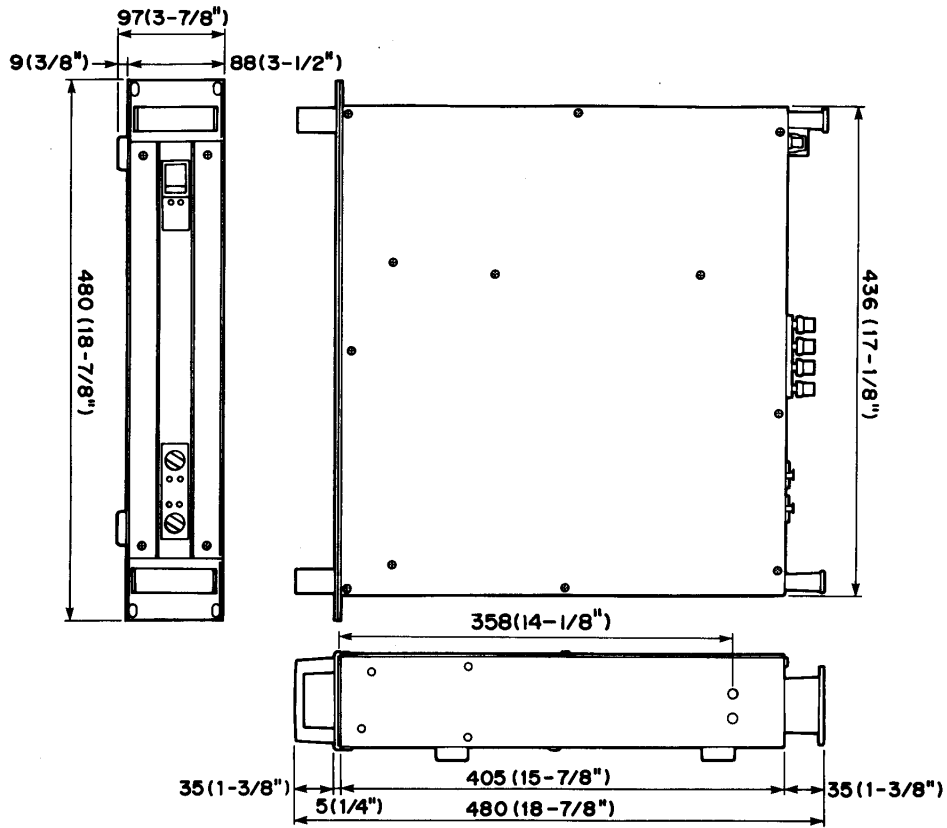

Unit: mm (Inch)

SERVICE

The PD2500 is supported by Yamaha's worldwide network of factory trained and qualified dealer service personnel. In the event of a problem, contact your nearest Yamaha dealer.

SINCE 1887



YAMAHA

NIPPON GAKKI CO., LTD. HAMAMATSU, JAPAN

QMD-207U Printed in Japan